



宏聚电子有限公司



HONGJU ELECTRONIC & METAL PRODUCTS CO.,LTD

MR-6

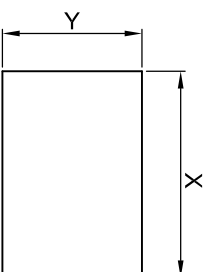
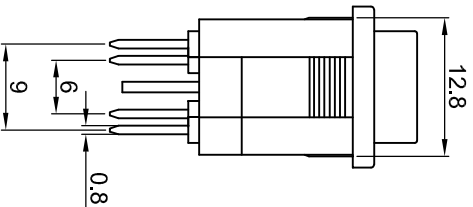
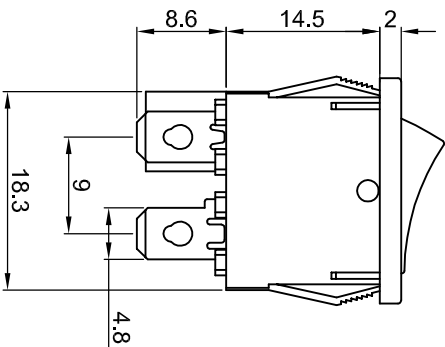
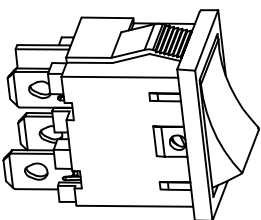
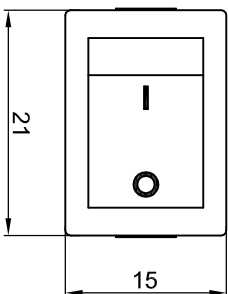
受控文件



CUT-OUT

Rating: 10A 125V AC (UL CUL) 
 6A 250V AC (VDE CQC CB) 
 Contact Resistance: 50mΩ Max
 Insulation Resistance: DC 500V 100MΩ Min
 Dielectric Strength: AC1500V 1 minute
 Operating Temperature: 0°C~85°C

	X	Y
	0.75~1.25	19.2-0.1 13.0+0.1
	1.25~2.00	19.4-0.1 13.0+0.1
	2.00~3.00	19.8-0.1 13.0+0.1



MATERIAL:

Body:Nylon66,UL rated:94V-2 min
 Actuator:Nylon66,UL rated:94V-2 min
 Terminal:Brass,silver or tin plated

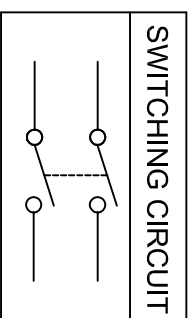

Marking	X	0	1	2	4	5	6	7
		None						开 关

公差 TOLERANCES .X± 0.3 .XX± 0.15

角度 ANGLE ± 1°

单位 DIMENSION UNIT mm.

版本 VER.	变更说明 CHANGE DESCRIPTION	日期 DATE	ECN NO.	批准 APPROVED BY	核对 CHECKED BY	绘图 DRAWN BY	品名 TITLE	图号 DRAWING NO
A1	重新整理发行	2009.09.21	N/A	李新超	李伟奇	黄雄阳	MR-6-210-CXN-BB	MR-6-210-CXN-BB_A1
A0	新发行	2008.04.16	N/A	李新超	李伟奇	黄雄阳	MR-6-210-CXN-BB	MR-6-210-CXN-BB_A1