

ACPL-M50L, ACPL-054L, ACPL-W50L and ACPL-K54L

Low Power, 1MBd Digital Optocoupler



Data Sheet



Description

The ACPL-M50L (single-channel in SO-5 footprint), ACPL-054L (dual-channel in SO-8 footprint), ACPL-W50L (single-channel in stretched SO-6 footprint) and ACPL-K54L (dual-channel in stretched SO-8 footprint) are low power, low-input current, 1MBd digital optocouplers.

This digital optocouplers use an insulating layer between the light emitting diode and an integrated photon detector to provide electrical insulation between input and output. Separate connections for the photodiode bias and output transistor collector increase the speed up to a hundred times over that of a conventional photo-transistor coupler by reducing the base-collector capacitance.

The ACPL-M50L/054L/W50L/K54L have an increased common mode transient immunity of 15kV/μs minimum at $V_{CM} = 1500V$ over a temperature range of -40 to 105°C. The current transfer ratio (CTR) is 140% typical for ACPL-M50L or 130% typical for ACPL-054L/W50L/K54L at $I_F = 3mA$. This digital optocoupler can be use in any TTL/CMOS, TTL/LSTTL or wide bandwidth analog applications.

Functional Diagram

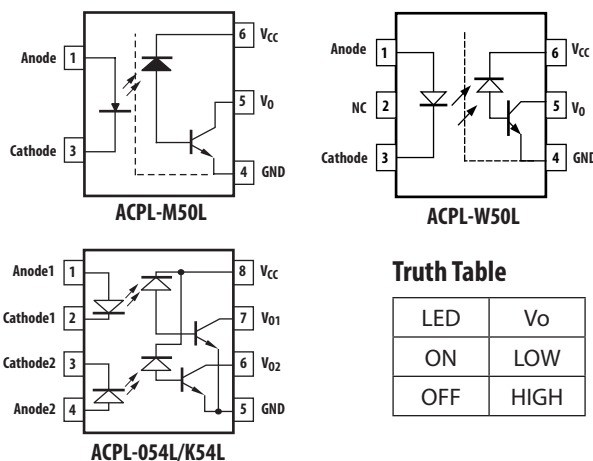

Truth Table

LED	Vo
ON	LOW
OFF	HIGH

The connection of a 0.1 μF bypass capacitor between pins 4 and 6 for ACPL-M50L/W50L and between pins 5 and 8 for ACPL-054L/K54L is recommended.

Features

- Wide supply voltage V_{CC} : 2.7V to 24V
- Low Drive Current: 3mA
- Open-Collector Output
- TTL compatible
- Compact SO-5, SO-8, stretched SO-6 and stretched SO-8 package
- 15 kV/μs High Common-Mode Rejection at $V_{CM} = 1500V$
- Guaranteed performance from Temperature Range: -40°C to +105°C
- Low Propagation Delay: 1μs max at 5V
- Worldwide Safety Approval:
 - UL1577 recognized, 3750Vrms/1min for ACPL-M50L/054L, 5000Vrms/1min for ACPL-W50L/K54L,
 - CSA Approval
 - IEC/EN/DIN EN 60747-5-5 Approval for Reinforced Insulation

Applications

- Communications Interface
- Digital Signal Isolation
- Micro-controller Interface
- Feedback Elements in Switching Power Supplies
- Digital isolation for A/D, D/A conversion Digital field

CAUTION: It is advised that normal static precautions be taken in handling and assembly of this component to prevent damage and/or degradation which may be induced by ESD.

Ordering Information

ACPL-M50L and ACPL-054L are UL Recognized with 3750 Vrms for 1 minute per UL1577. ACPL-W50L and ACPL-K54L are UL Recognized with 5000 Vrms for 1 minute per UL1577

Part Number	Options	Package	Surface Mount	Tape & Reel	IEC/EN/DIN EN 60747-5-5	Quantity
	RoHS Compliant					
ACPL-M50L	-000E	SO-5	X			100 per tube
	-060E		X		X	100 per tube
	-500E		X	X		1500 per reel
	-560E		X	X	X	1500 per reel
ACPL-054L	-000E	SO-8	X			100 per tube
	-060E		X		X	100 per tube
	-500E		X	X		1500 per reel
	-560E		X	X	X	1500 per reel
ACPL-W50L	-000E	Stretched SO-6	X			100 per tube
	-060E		X		X	100 per tube
	-500E		X	X		1000 per reel
	-560E		X	X	X	1000 per reel
ACPL-K54L	-000E	Stretched SO-8	X			80 per tube
	-060E		X		X	80 per tube
	-500E		X	X		1000 per reel
	-560E		X	X	X	1000 per reel

To order, choose a part number from the part number column and combine with the desired option from the option column to form an order entry.

Example 1:

ACPL-M50L-500E to order product of Mini-flat Surface Mount 5-pin package in Tape and Reel packaging with RoHS compliant.

Option datasheets are available. Contact your Avago sales representative or authorized distributor for information.

Package Outline Drawings

ACPL-M50L Small Outline SO-5 Package (JEDEC MO-155)

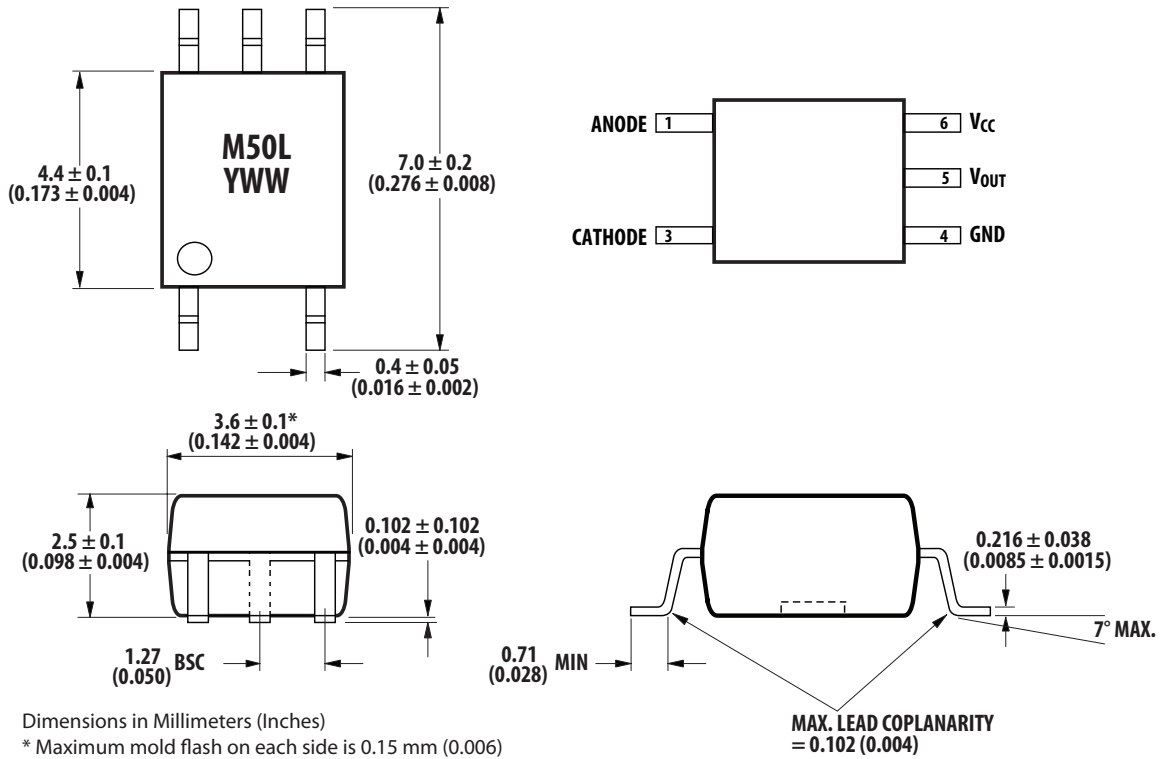

Land Pattern Recommendation

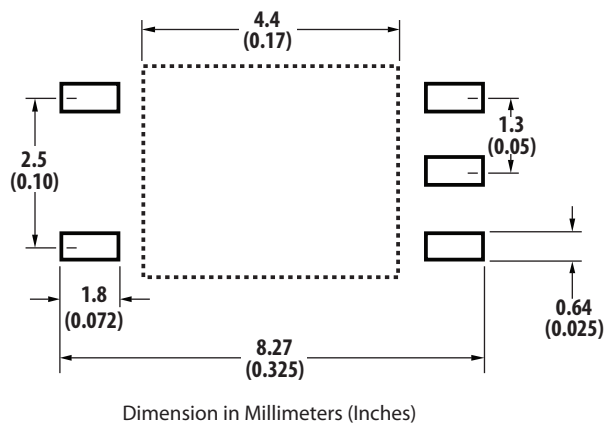

ACPL-054L (Small Outline S0-8 Package)

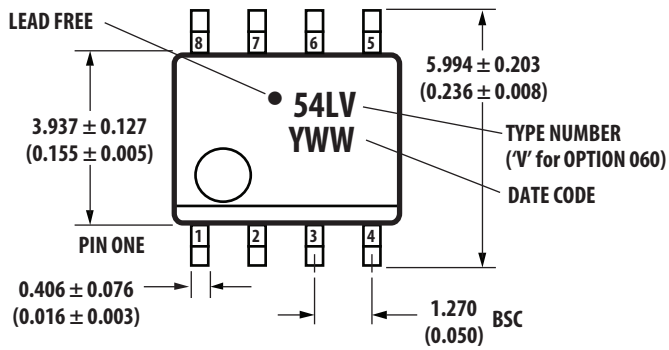

LAND PATTERN RECOMMENDATION

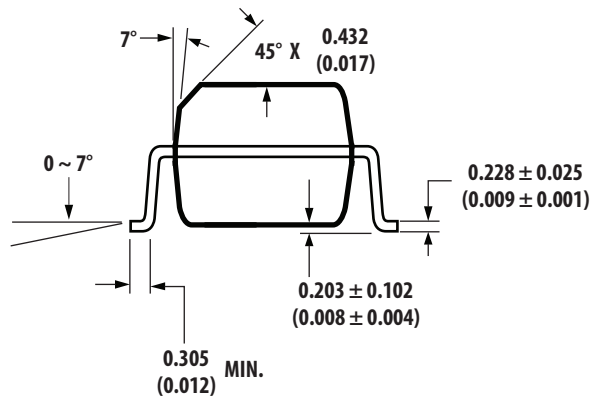
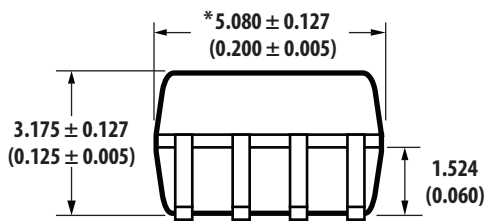
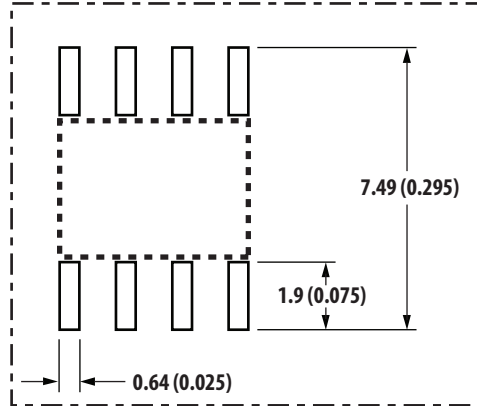

* Total package length (inclusive of mold flash)
5.207 ± 0.254 (0.205 ± 0.010)

Dimensions in Millimeters (Inches).
Lead coplanarity = 0.10 mm (0.004 inches) max.
Option number 500 not marked.
Note: Floating lead protrusion is 0.15 mm (6 mils) max.

ACPL-W50L Stretched S0-6 Package

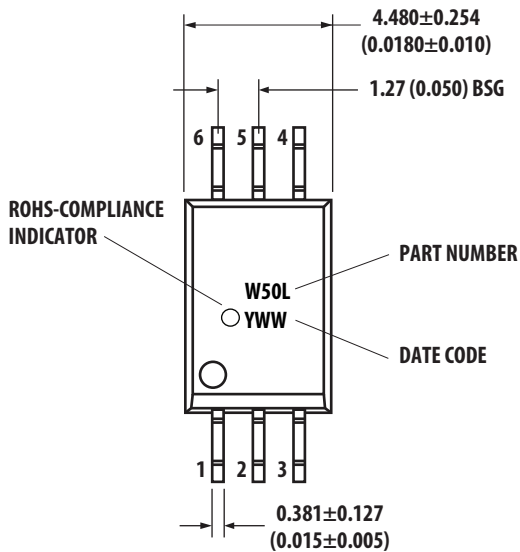

LAND PATTERN RECOMMENDATION

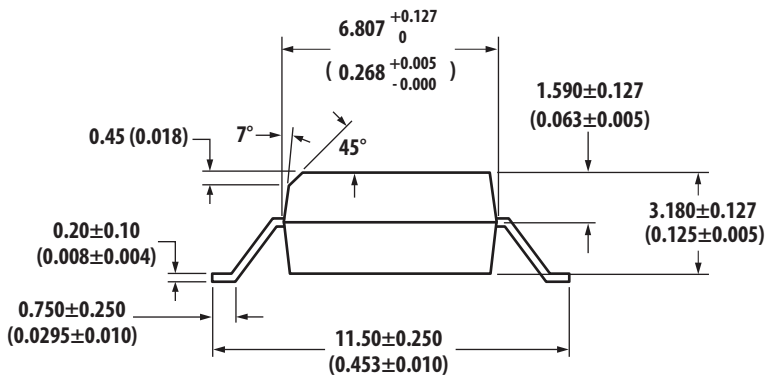
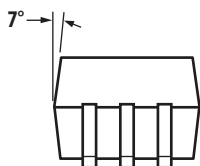
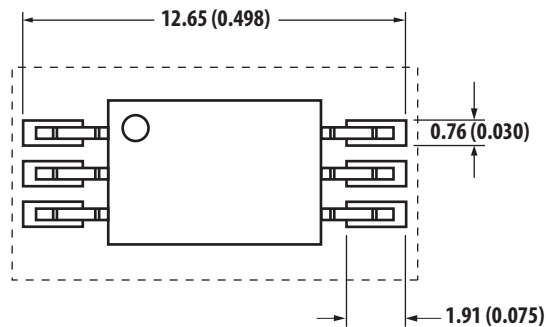

Dimensions in Millimeters (Inches).
Lead coplanarity = 0.1 mm (0.004 inches).

ACPL-K54L Stretched SO-8 Package

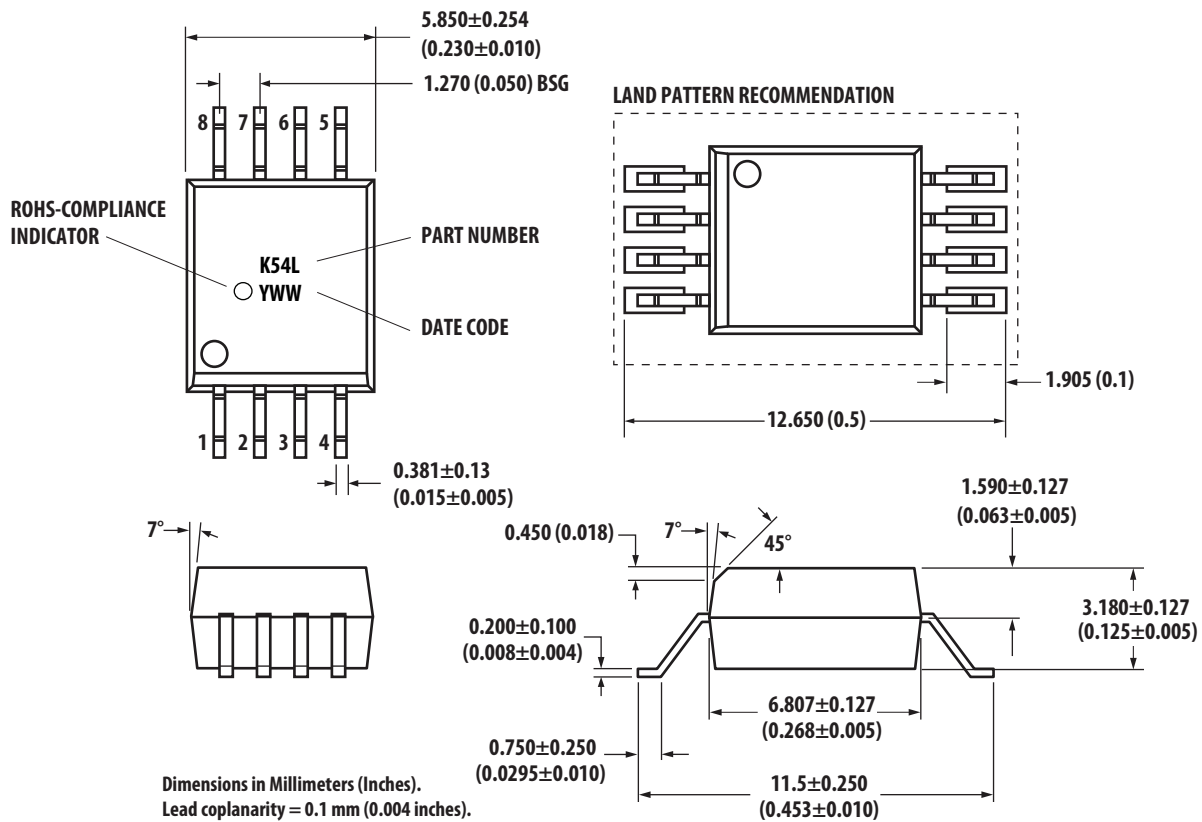

Solder Reflow Profile

Recommended reflow condition as per JEDEC Standard, J-STD-020 (latest revision). Non-Halide Flux should be used.

Regulatory Information

The ACPL-M50L/054L/W50L/K54L will be approved by the following organizations:

UL

Approval under UL 1577, component recognition program up to $V_{ISO} = 3750 V_{RMS}$ for ACPL-M50L/054L and $V_{ISO} = 5000 V_{RMS}$ for ACPL-W50L/K54L.

CSA

Approval under CSA Component Acceptance Notice #5.

IEC/EN/DIN EN 60747-5-5 (Option 060E only)

Insulation and Safety Related Specifications

Parameter	Symbol	ACPL-W50L			Units	Conditions
		ACPL-M50L	ACPL-054L	ACPL-K54L		
Minimum External Air Gap (Clearance)	L(101)	5	4.9	8	mm	Measured from input terminals to output terminals, shortest distance through air.
Minimum External Tracking (Creepage)	L(102)	5	4.8	8	mm	Measured from input terminals to output terminals, shortest distance path along body.
Minimum Internal Plastic Gap (Internal Clearance)		0.08	0.08	0.08	mm	Through insulation distance conductor to conductor, usually the straight line distance thickness between the emitter and detector.
Tracking Resistance (Comparative Tracking Index)	CTI	175	175	175	Volts	DIN IEC 112/VDE 0303 Part 1
Isolation Group		IIIa	IIIa	IIIa		Material Group (DIN VDE 0110, 1/89, Table 1)

IEC/EN/DIN EN 60747-5-5 Insulation Characteristics* (Option 060E)

Description	Symbol	Characteristic		Unit
		ACPL-M50L/ 054L	ACPL-W50L/ K54L	
Installation classification per DIN VDE 0110/39, Table 1				
for rated mains voltage $\leq 150 V_{rms}$		I – IV	I – IV	
for rated mains voltage $\leq 300 V_{rms}$		I – III	I – IV	
for rated mains voltage $\leq 600 V_{rms}$		I – II	I – III	
for rated mains voltage $\leq 1000 V_{rms}$			I – III	
Climatic Classification		55/105/21	55/105/21	
Pollution Degree (DIN VDE 0110/39)		2	2	
Maximum Working Insulation Voltage	V_{IORM}	560	1140	Vpeak
Input to Output Test Voltage, Method b* $V_{IORM} \times 1.875 = V_{PR}$, 100% Production Test with $t_m = 1$ sec, Partial discharge < 5 pC	V_{PR}	1050	2137	Vpeak
Input to Output Test Voltage, Method a* $V_{IORM} \times 1.6 = V_{PR}$, Type and Sample Test, $t_m = 10$ sec, Partial discharge < 5 pC	V_{PR}	896	1824	Vpeak
Highest Allowable Overvoltage (Transient Overvoltage $t_{ini} = 60$ sec)	V_{IOTM}	6000	8000	Vpeak
Safety-limiting values – maximum values allowed in the event of a failure.				
Case Temperature	T_S	150	175	°C
Input Current**	$I_{S, INPUT}$	150	230	mA
Output Power**	$P_{S, OUTPUT}$	600	600	mW
Insulation Resistance at T_S , $V_{IO} = 500$ V	R_S	$>10^9$	$>10^9$	Ω

* Refer to the optocoupler section of the Isolation and Control Components Designer's Catalog, under Product Safety Regulations section, (IEC/EN/DIN EN 60747-5-5) for a detailed description of Method a and Method b partial discharge test profiles.

** Refer to the following figure for dependence of P_S and I_S on ambient temperature.

Absolute Maximum Ratings

Parameter	Symbol	Min.	Max.	Units
Storage Temperature	T_S	-55	125	°C
Operating Temperature	T_A	-40	105	°C
Lead Soldering Cycle	Temperature		260	°C
	Time		10	s
Average Forward Input Current ^[1]	$I_{F(avg)}$		20	mA
Peak Forward Input Current ^[2] (50% duty cycle, 1ms pulse width)	$I_{F(peak)}$		40	mA
Peak Transient Input Current ($\leq 1\mu s$ pulse width, 300ps)	$I_{F(trans)}$		1	A
Reversed Input Voltage	V_R		5	V
Input Power Dissipation ^[3]	P_{IN}		36	mW
Output Power Dissipation ^[4]	P_O		45	mW
Average Output Current	$I_{O(AVG)}$		8	mA
Peak Output Current	$I_{O(PEAK)}$		16	mA
Supply Voltage	V_{CC}	-0.5	30	V
Output Voltage	V_O	-0.5	24	V
Solder Reflow Temperature Profile	See Package Outline Drawings section			

Notes:

1. Derate linearly above 85°C free-air temperature at a rate of 0.5 mA/°C.
2. Derate linearly above 85°C free-air temperature at a rate of 1.0 mA/°C.
3. Derate linearly above 85°C free-air temperature at a rate of 0.9 mW/°C.
4. Derate linearly above 85°C free-air temperature at a rate of 1.2 mW/°C.

Recommended Operating Conditions

Parameter	Symbol	Min.	Max.	Units
Supply Voltage	V_{CC}	2.7	24	V
Input Current, High Level	I_{FH}	3	10	mA
Operating Temperature	T_A	-40	105	°C
Forward Input Voltage (OFF)	$V_{F(OFF)}$		0.8	V

Electrical Specifications (DC)

Over recommended operating $T_A = -40^\circ\text{C}$ to 105°C , supply voltage ($2.7\text{V} \leq V_{CC} \leq 24\text{V}$) and unless otherwise specified. All typicals are at $T_A=25^\circ\text{C}$

Parameter	Sym.	Part Number	Min.	Typ.	Max.	Units	Conditions	Fig.
Current Transfer Ratio	CTR ^[1]	ACPL-M50L	100	140	200	%	$T_A = 25^\circ\text{C}$ $V_O=0.4\text{V}$ $V_{CC}=3.3\text{V}$ or 5V	2,3
			80			%	$V_O=0.5\text{V}$ $I_F=3\text{mA}$	
		ACPL-054L	93	130	200	%	$T_A = 25^\circ\text{C}$ $V_O=0.4\text{V}$ $V_{CC}=3.3\text{V}$ or 5V	2,3
		ACPL-W50L ACPL-K54L	53			%	$V_O=0.5\text{V}$ $I_F=3\text{mA}$	
Logic Low Output Voltage	V_{OL}		0.2	0.4	V	$T_A = 25^\circ\text{C}$ $I_O=3\text{mA}$ $V_{CC}=3.3\text{V}$ or 5V		
			0.2	0.5	V	$I_O=1.6\text{mA}$ $I_F=3\text{mA}$		
Logic High Output Current	I_{OH}		0.003	0.5	μA	$T_A = 25^\circ\text{C}$ $V_O=V_{CC}=5.5\text{V}$ $I_F=0\text{mA}$	4,5	
			0.01	1		$V_O=V_{CC}=24\text{V}$		
				80		$V_O=V_{CC}=24\text{V}$		
Logic Low Supply Current per Channel	I_{CCL}		36	100	μA	$I_F=3\text{mA}$, $V_O=\text{open}$, $V_{CC}=24\text{V}$		
Logic High Supply Current per Channel	I_{CCH}		0.02	2	μA	$I_F=0\text{mA}$, $V_O=\text{open}$, $V_{CC}=24\text{V}$		
Input Forward Voltage	V_F		1.5	1.8	V	$T_A=25^\circ\text{C}$ $I_F=3\text{mA}$	1	
			1.5	1.95	V	$I_F=3\text{mA}$		
Input Reversed Breakdown Voltage	BV_R	5			V	$I_R=10\mu\text{A}$		
Temperature Coefficient of Forward Voltage	$\frac{\Delta V_F}{\Delta T_A}$		-1.6		$\text{mV}/^\circ\text{C}$	$I_F=3\text{mA}$		
Input Capacitance	C_{IN}		77		pF	$F = 1\text{MHz}$, $V_F = 0$		

Notes:

1. CURRENT TRANSFER RATIO in percent is defined as the ratio of output collector current, I_O , to the forward LED input current, I_F , times 100%.

Switching Specifications (ACPL-M50L)

Over recommended operating ($T_A = -40^\circ\text{C}$ to 105°C), $I_F = 3\text{mA}$, ($2.7\text{V} \leq V_{CC} \leq 24\text{V}$), unless otherwise specified.

Parameter	Symbol	Min	Typ	Max	Units	Test Conditions	Fig.
Propagation Delay Time to Logic Low at Output	T_{PHL}	0.2	0.5		μs	$T_A=25^\circ\text{C}$ Pulse: $f=10\text{kHz}$, Duty cycle=50%, $I_F=3\text{mA}$, $V_{CC}=3.3\text{V}$, $R_L=1.2\text{k}\Omega$, $C_L=15\text{pF}$, $V_{THHL}=1.5\text{V}$	14
		0.2	1		μs		6a, 14
		0.22	0.5		μs	$T_A=25^\circ\text{C}$ Pulse: $f=10\text{kHz}$, Duty cycle=50%, $I_F=3\text{mA}$, $V_{CC}=5.0\text{V}$, $R_L=1.9\text{k}\Omega$, $C_L=15\text{pF}$, $V_{THHL}=1.5\text{V}$	14
		0.22	1		μs		7a, 14
		0.33	0.7		μs	$T_A=25^\circ\text{C}$ Pulse: $f=10\text{kHz}$, Duty cycle=50%, $I_F=3\text{mA}$, $V_{CC}=24\text{V}$, $R_L=10\text{k}\Omega$, $C_L=15\text{pF}$, $V_{THHL}=1.5\text{V}$	14
		0.33	1.3		μs		8a, 14
Propagation Delay Time to Logic High at Output	T_{PLH}	0.38	0.8		μs	$T_A=25^\circ\text{C}$ Pulse: $f=10\text{kHz}$, Duty cycle=50%, $I_F=3\text{mA}$, $V_{CC}=3.3\text{V}$, $R_L=1.2\text{k}\Omega$, $C_L=15\text{pF}$, $V_{THHL}=2.0\text{V}$	14
		0.38	1.2		μs		6a, 14
		0.31	0.7		μs	$T_A=25^\circ\text{C}$ Pulse: $f=10\text{kHz}$, Duty cycle=50%, $I_F=3\text{mA}$, $V_{CC}=5.0\text{V}$, $R_L=1.9\text{k}\Omega$, $C_L=15\text{pF}$, $V_{THHL}=2.0\text{V}$	14
		0.31	1		μs		7a, 14
		0.3	0.7		μs	$T_A=25^\circ\text{C}$ Pulse: $f=10\text{kHz}$, Duty cycle=50%, $I_F=3\text{mA}$, $V_{CC}=24\text{V}$, $R_L=10\text{k}\Omega$, $C_L=15\text{pF}$, $V_{THHL}=2.0\text{V}$	14
		0.3	1		μs		8a, 14
Pulse Width Distortion ^[1]	PWD	0.18	0.8		μs	$T_A=25^\circ\text{C}$ Pulse: $f=10\text{kHz}$, Duty cycle=50%, $I_F=3\text{mA}$, $V_{CC}=3.3\text{V}$, $R_L=1.2\text{k}\Omega$, $C_L=15\text{pF}$, $V_{THHL}=1.5\text{V}$, $V_{THLH}=2.0\text{V}$	14
		0.18	1.2		μs		14
		0.1	0.7		μs	$T_A=25^\circ\text{C}$ Pulse: $f=10\text{kHz}$, Duty cycle=50%, $I_F=3\text{mA}$, $V_{CC}=5.0\text{V}$, $R_L=1.9\text{k}\Omega$, $C_L=15\text{pF}$, $V_{THHL}=1.5\text{V}$, $V_{THLH}=2.0\text{V}$	14
		0.1	1		μs		14
		0.1	0.7		μs	$T_A=25^\circ\text{C}$ Pulse: $f=10\text{kHz}$, Duty cycle=50%, $I_F=3\text{mA}$, $V_{CC}=24\text{V}$, $R_L=10\text{k}\Omega$, $C_L=15\text{pF}$, $V_{THHL}=1.5\text{V}$, $V_{THLH}=2.0\text{V}$	14
		0.1	1		μs		14
Propagation Delay Difference Between Any two Parts ^[2]	t_{psk}	0.18	0.7		μs	$T_A=25^\circ\text{C}$ Pulse: $f=10\text{kHz}$, Duty cycle=50%, $I_F=3\text{mA}$, $V_{CC}=3.3\text{V}$, $R_L=1.2\text{k}\Omega$, $C_L=15\text{pF}$, $V_{THHL}=1.5\text{V}$, $V_{THLH}=2.0\text{V}$	
		0.1	0.6		μs	$T_A=25^\circ\text{C}$ Pulse: $f=10\text{kHz}$, Duty cycle=50%, $I_F=3\text{mA}$, $V_{CC}=5.0\text{V}$, $R_L=1.9\text{k}\Omega$, $C_L=15\text{pF}$, $V_{THHL}=1.5\text{V}$, $V_{THLH}=2.0\text{V}$	
		0.1	0.6		μs	$T_A=25^\circ\text{C}$ Pulse: $f=10\text{kHz}$, Duty cycle=50%, $I_F=3\text{mA}$, $V_{CC}=24\text{V}$, $R_L=10\text{k}\Omega$, $C_L=15\text{pF}$, $V_{THHL}=1.5\text{V}$, $V_{THLH}=2.0\text{V}$	
Common Mode Transient Immunity at Logic High Output ^[3]	$ CM_H $	15	25		$\text{kV}/\mu\text{s}$	$V_{CM}=1500\text{V}$, $I_F=0\text{mA}$, $T_A=25^\circ\text{C}$, $R_L=1.2\text{k}\Omega$ or $1.9\text{k}\Omega$, $V_{CC}=3.3\text{V}$ or 5V	15
Common Mode Transient Immunity at Logic Low Output ^[4]	$ CM_L $	15	20		$\text{kV}/\mu\text{s}$	$V_{CM}=1500\text{V}$, $I_F=3\text{mA}$, $T_A=25^\circ\text{C}$, $R_L=1.2\text{k}\Omega$, $V_{CC}=5\text{V}$	15
		10	15		$\text{kV}/\mu\text{s}$	$V_{CM}=1500\text{V}$, $I_F=3\text{mA}$, $T_A=25^\circ\text{C}$, $R_L=1.2\text{k}\Omega$, $V_{CC}=3.3\text{V}$	15

Switching Specifications (ACPL-054L/W50L/K54L)

Over recommended operating ($T_A = -40^\circ\text{C}$ to 105°C), $I_F = 3\text{mA}$, ($2.7\text{V} \leq V_{CC} \leq 24\text{V}$), unless otherwise specified.

Parameter	Symbol	Min	Typ	Max	Units	Test Conditions	Fig.
Propagation Delay Time to Logic Low at Output	t_{PHL}	0.2	0.5		μs	$T_A=25^\circ\text{C}$ Pulse: $f=10\text{kHz}$, Duty cycle=50%, $I_F=3\text{mA}$, $V_{CC}=3.3\text{V}$, $R_L=1.8\text{k}\Omega$, $C_L=15\text{pF}$, $V_{THHL}=1.5\text{V}$	14
		0.2	1		μs		6b, 14
		0.22	0.5		μs	$T_A=25^\circ\text{C}$ Pulse: $f=10\text{kHz}$, Duty cycle=50%, $I_F=3\text{mA}$, $V_{CC}=5.0\text{V}$, $R_L=2.9\text{k}\Omega$, $C_L=15\text{pF}$, $V_{THHL}=1.5\text{V}$	14
		0.22	1		μs		7b, 14
		0.33	0.7		μs	$T_A=25^\circ\text{C}$ Pulse: $f=10\text{kHz}$, Duty cycle=50%, $I_F=3\text{mA}$, $V_{CC}=24\text{V}$, $R_L=14.8\text{k}\Omega$, $C_L=15\text{pF}$, $V_{THHL}=1.5\text{V}$	14
		0.33	1.3		μs		8b, 14
Propagation Delay Time to Logic High at Output	t_{PLH}	0.38	0.8		μs	$T_A=25^\circ\text{C}$ Pulse: $f=10\text{kHz}$, Duty cycle=50%, $I_F=3\text{mA}$, $V_{CC}=3.3\text{V}$, $R_L=1.8\text{k}\Omega$, $C_L=15\text{pF}$, $V_{THHL}=2.0\text{V}$	14
		0.38	1.4		μs		6b, 14
		0.31	0.7		μs	$T_A=25^\circ\text{C}$ Pulse: $f=10\text{kHz}$, Duty cycle=50%, $I_F=3\text{mA}$, $V_{CC}=5.0\text{V}$, $R_L=2.9\text{k}\Omega$, $C_L=15\text{pF}$, $V_{THHL}=2.0\text{V}$	14
		0.31	1		μs		7b, 14
		0.3	0.7		μs	$T_A=25^\circ\text{C}$ Pulse: $f=10\text{kHz}$, Duty cycle=50%, $I_F=3\text{mA}$, $V_{CC}=24\text{V}$, $R_L=14.8\text{k}\Omega$, $C_L=15\text{pF}$, $V_{THHL}=2.0\text{V}$	14
		0.3	1		μs		8b, 14
Pulse Width Distortion ^[1]	PWD	0.18	0.8		μs	$T_A=25^\circ\text{C}$ Pulse: $f=10\text{kHz}$, Duty cycle=50%, $I_F=3\text{mA}$, $V_{CC}=3.3\text{V}$, $R_L=1.8\text{k}\Omega$, $C_L=15\text{pF}$, $V_{THHL}=1.5\text{V}$, $V_{THLH}=2.0\text{V}$	14
		0.18	1.4		μs		14
		0.1	0.7		μs	$T_A=25^\circ\text{C}$ Pulse: $f=10\text{kHz}$, Duty cycle=50%, $I_F=3\text{mA}$, $V_{CC}=5.0\text{V}$, $R_L=2.9\text{k}\Omega$, $C_L=15\text{pF}$, $V_{THHL}=1.5\text{V}$, $V_{THLH}=2.0\text{V}$	14
		0.1	1		μs		14
		0.1	0.7		μs	$T_A=25^\circ\text{C}$ Pulse: $f=10\text{kHz}$, Duty cycle=50%, $I_F=3\text{mA}$, $V_{CC}=24\text{V}$, $R_L=14.8\text{k}\Omega$, $C_L=15\text{pF}$, $V_{THHL}=1.5\text{V}$, $V_{THLH}=2.0\text{V}$	14
		0.1	1		μs		14
Propagation Delay Difference Between Any two Parts ^[2]	t_{psk}	0.18	0.7		μs	$T_A=25^\circ\text{C}$ Pulse: $f=10\text{kHz}$, Duty cycle=50%, $I_F=3\text{mA}$, $V_{CC}=3.3\text{V}$, $R_L=1.8\text{k}\Omega$, $C_L=15\text{pF}$, $V_{THHL}=1.5\text{V}$, $V_{THLH}=2.0\text{V}$	
		0.1	0.6		μs	$T_A=25^\circ\text{C}$ Pulse: $f=10\text{kHz}$, Duty cycle=50%, $I_F=3\text{mA}$, $V_{CC}=5.0\text{V}$, $R_L=2.9\text{k}\Omega$, $C_L=15\text{pF}$, $V_{THHL}=1.5\text{V}$, $V_{THLH}=2.0\text{V}$	
		0.1	0.6		μs	$T_A=25^\circ\text{C}$ Pulse: $f=10\text{kHz}$, Duty cycle=50%, $I_F=3\text{mA}$, $V_{CC}=24\text{V}$, $R_L=14.8\text{k}\Omega$, $C_L=15\text{pF}$, $V_{THHL}=1.5\text{V}$, $V_{THLH}=2.0\text{V}$	
Common Mode Transient Immunity at Logic High Output ^[3]	$ CM_H $	15	25		$\text{kV}/\mu\text{s}$	$V_{CM}=1500\text{V}$, $I_F=0\text{mA}$, $T_A=25^\circ\text{C}$, $R_L=1.8\text{k}\Omega$ or $2.9\text{k}\Omega$, $V_{CC}=3.3\text{V}$ or 5V	15
Common Mode Transient Immunity at Logic Low Output ^[4]	$ CM_L $	15	20		$\text{kV}/\mu\text{s}$	$V_{CM}=1500\text{V}$, $I_F=4\text{mA}$, $T_A=25^\circ\text{C}$, $R_L=2.9\text{k}\Omega$, $V_{CC}=5\text{V}$	15
		15	20		$\text{kV}/\mu\text{s}$	$V_{CM}=1500\text{V}$, $I_F=3\text{mA}$, $T_A=25^\circ\text{C}$, $R_L=1.8\text{k}\Omega$, $V_{CC}=3.3\text{V}$	15

Notes:

1. Pulse Width Distortion (PWD) is defined as $|t_{PHL} - t_{PLH}|$ for any given device.
2. The difference between t_{PLH} and t_{PHL} between any two parts under the same test condition. (See IPM Dead Time and Propagation Delay Specifications section.)
3. Common transient immunity in a Logic High level is the maximum tolerable (positive) dV_{CM}/dt on the rising edge of the common mode pulse, V_{CM} , to assure that the output will remain in a Logic High state (i.e., $V_O > 2.0\text{V}$).
4. Common mode transient immunity in a Logic Low level is the maximum tolerable (negative) dV_{CM}/dt on the falling edge of the common mode pulse signal, V_{CM} to assure that the output will remain in a Logic Low state (i.e., $V_O < 0.8\text{V}$).

Package Characteristics

All Typical at $T_A = 25^\circ\text{C}$.

Parameter	Symbol	Part Number	Min.	Typ.	Max.	Units	Test Conditions
Input-Output Momentary Withstand Voltage ^[1,2]	V _{ISO}	ACPL-M50L/054L	3750			V _{rms}	RH ≤ 50%, t = 1 min., T _A = 25°C
		ACPL-W50L/K54L	5000				
Input-Output Resistance ^[1]	R _{I-O}			10 ¹⁴		Ω	V _{I-O} = 500 Vdc
Input-Output Capacitance ^[1]	C _{I-O}			0.6		pF	f = 1 MHz, T _A = 25°C
Input-Input Insulation Leakage Current ^[3]	I _{I-I}			0.005		μA	RH ≤ 45%, t = 5 s V _{I-I} = 500Vdc
Input-Input Resistance ^[3]	R _{I-I}			10 ¹¹		Ω	
Input-Input Capacitance ^[3]	C _{I-I}			0.25		pF	f = 1 MHz

Notes:

1. Device considered a two terminal device: pins 1 and 3 shorted together and pins 4, 5 and 6 shorted together for ACPL-M50L, pins 1, 2, 3 and 4 shorted together and pins 5, 6, 7 and 8 shorted together for ACPL-054L/K54L, pins 1, 2 and 3 shorted together and pins 4, 5 and 6 shorted together for ACPL-W50L.
2. In accordance with UL 1577, each optocoupler is proof tested by applying an insulation test voltage $\geq 4500 V_{RMS}$ for 1 second for ACPL-M50L/054L and $\geq 6000 V_{RMS}$ for 1 second for ACPL-W50L/K54L (leakage detection current limit, $I_{I-O} \leq 5 \mu\text{A}$).
3. Measured between pins 1 and 2 shorted together and pins 3 and 4 shorted together for ACPL-054L/K54L.

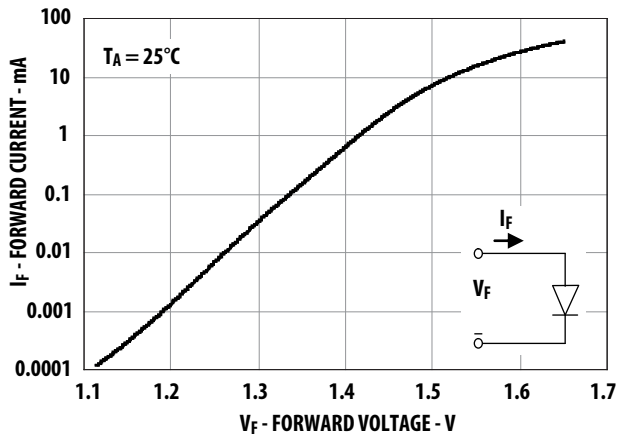

Figure 1. Input Current vs. Forward Voltage

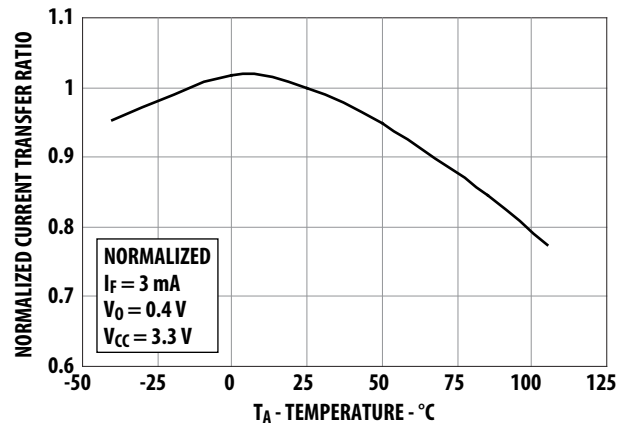

Figure 2. Typical Current Transfer Ratio vs. Temperature

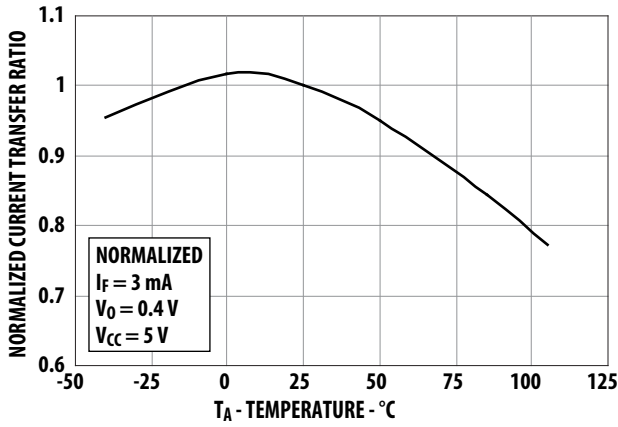

Figure 3. Typical Current Transfer Ratio vs. Temperature

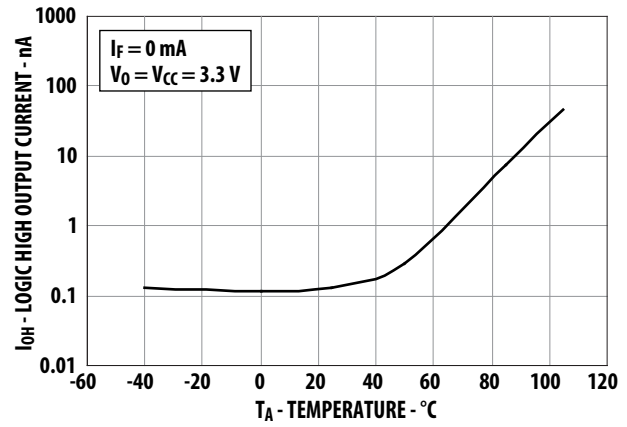

Figure 4. Typical Logic High Output Current vs. Temperature

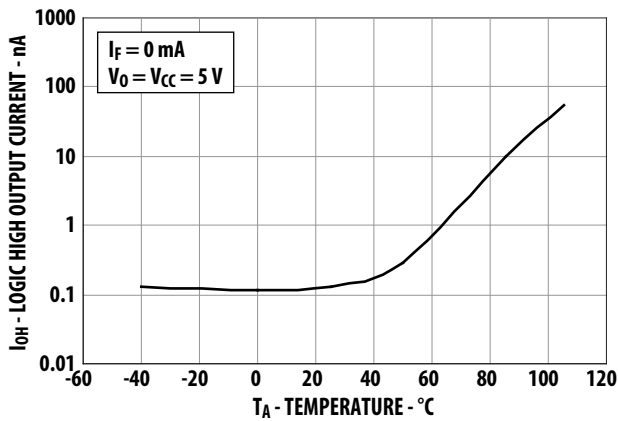

Figure 5. Typical Logic High Output Current vs. Temperature

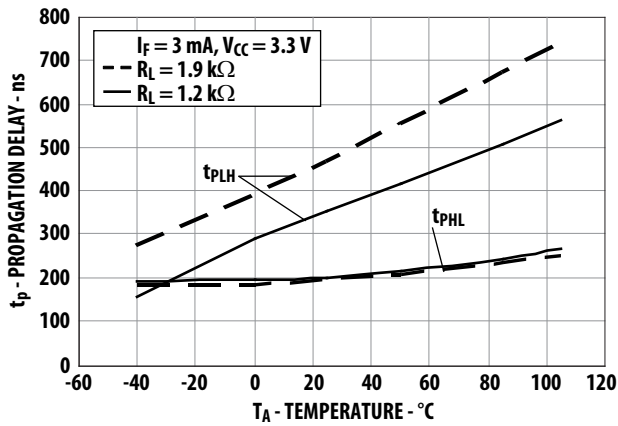

Figure 6a. Typical Propagation Delay vs. Temperature (ACPL-M50L)

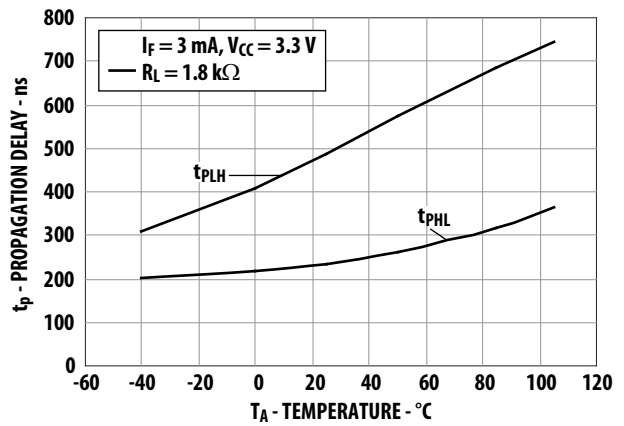

Figure 6b. Typical Propagation Delay vs. Temperature (ACPL-054L/W50L/K54L)

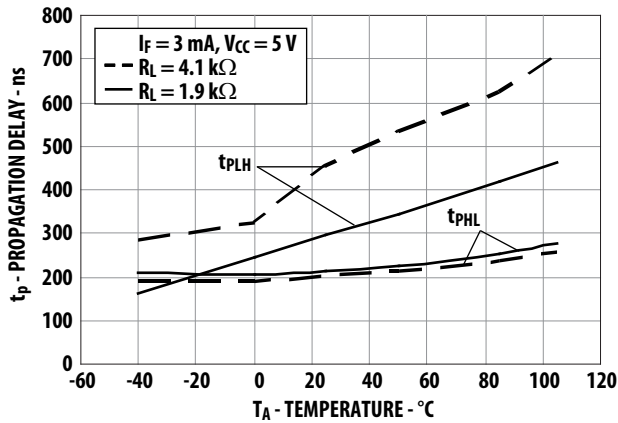

Figure 7a. Typical Propagation Delay vs. Temperature (ACPL-M50L)

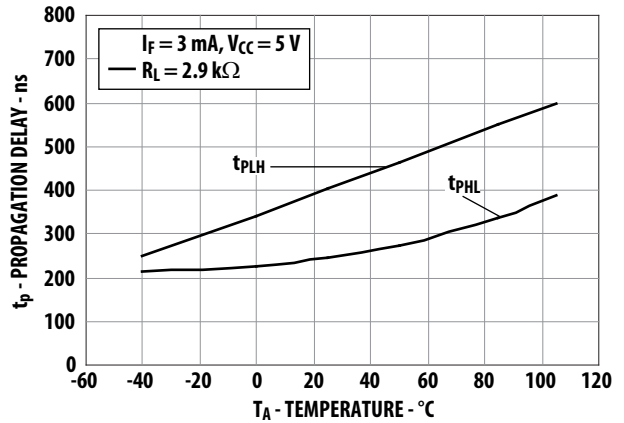

Figure 7b. Typical Propagation Delay vs. Temperature (ACPL-054L/W50L/K54L)

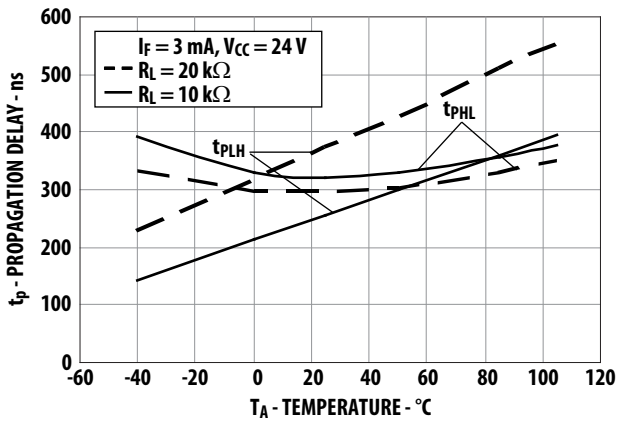

Figure 8a. Typical Propagation Delay vs. Temperature (ACPL-M50L)

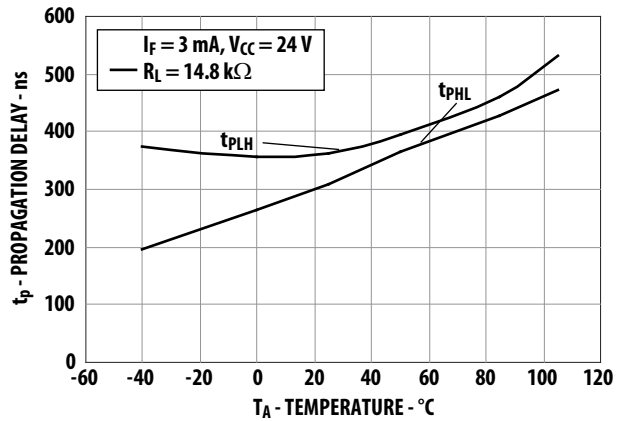

Figure 8b. Typical Propagation Delay vs. Temperature (ACPL-054L/W50L/K54L)

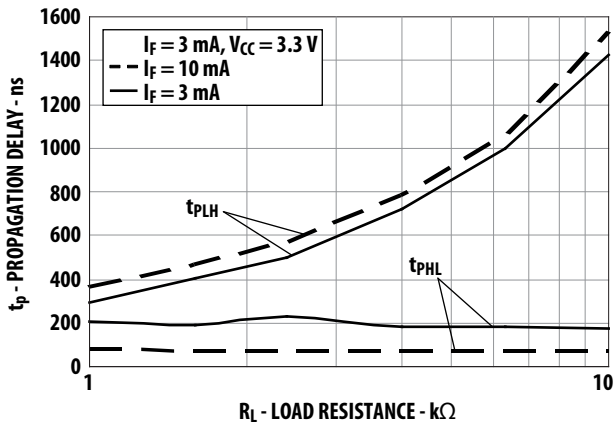

Figure 9. Typical Propagation Delay vs. Load Resistance

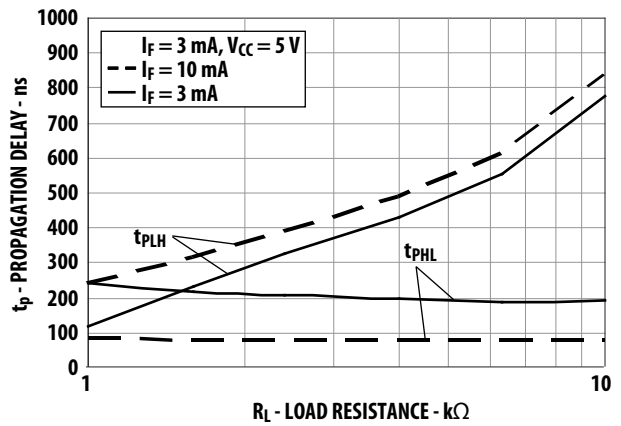

Figure 10. Typical Propagation Delay vs. Load Resistance

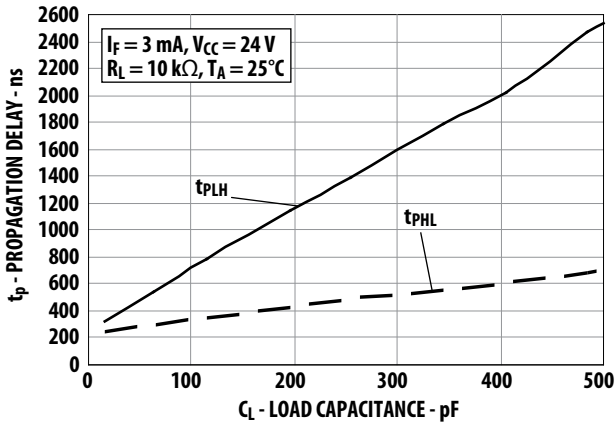

Figure 11a. Typical Propagation delay vs. Load Capacitance (ACPL-M50L)

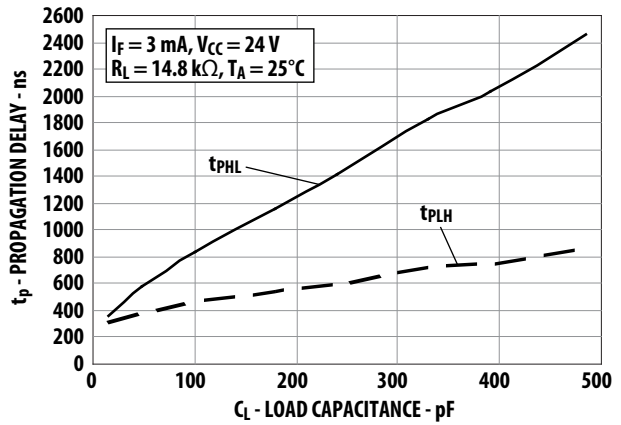

Figure 11b. Typical Propagation delay vs. Load Capacitance (ACPL-054L/W50L/K54L)

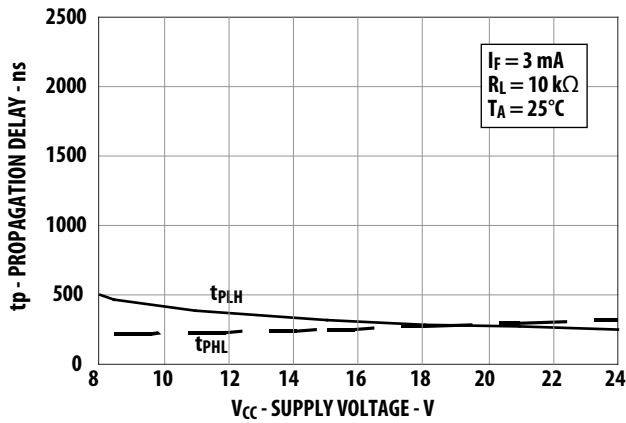

Figure 12a. Typical Propagation Delay vs. Supply Voltage (ACPL-M50L)

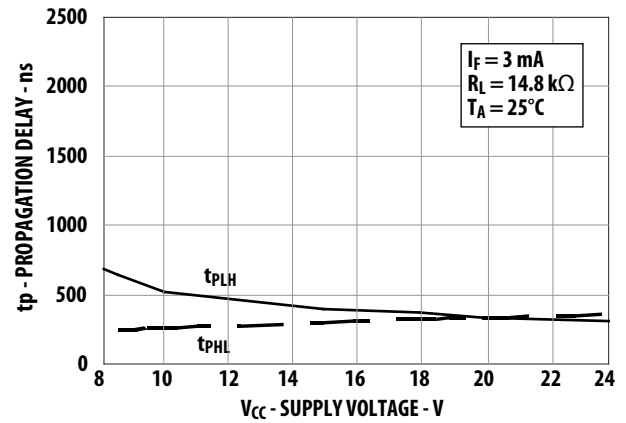

Figure 12b. Typical Propagation Delay vs. Supply Voltage (ACPL-054L/W50L/K54L)

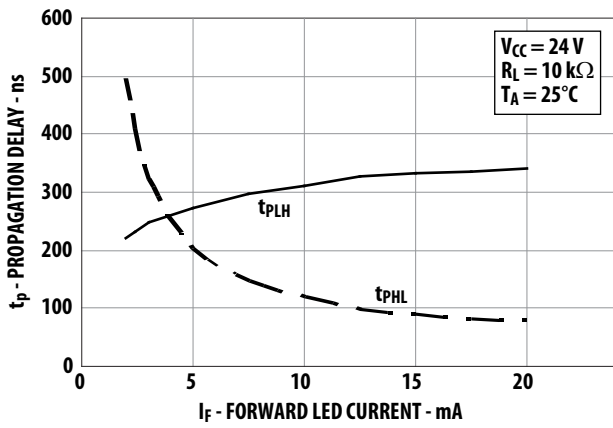

Figure 13a. Typical Propagation Delay vs. Supply Current (ACPL-M50L)

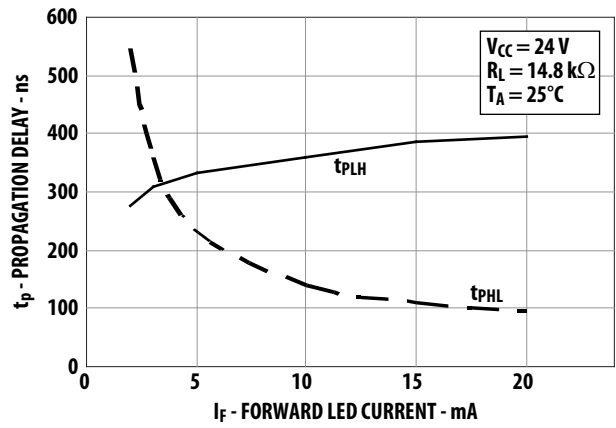

Figure 13b. Typical Propagation Delay vs. Supply Current (ACPL-054L/W50L/K54L)

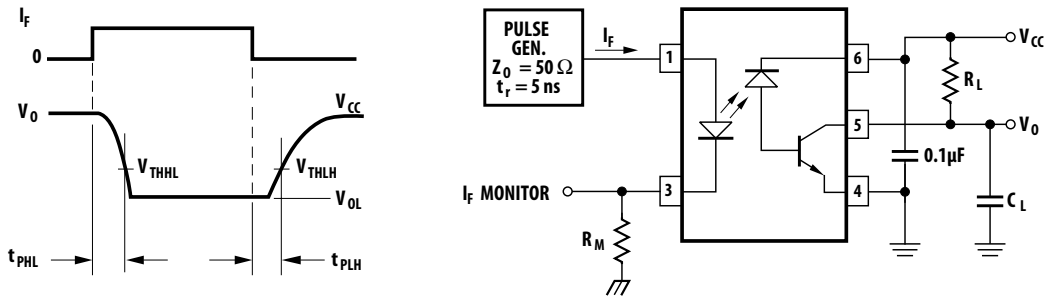

Figure 14. Switching Test Circuits

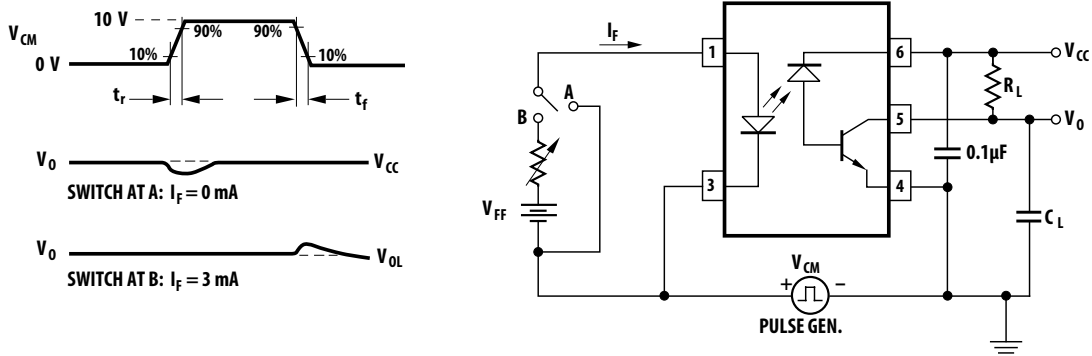

Figure 15. Test Circuit for Transient Immunity and typical waveforms

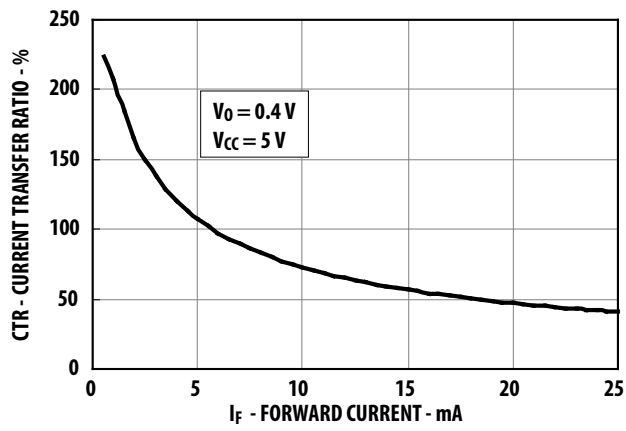

Figure 16. Current Transfer Ratio versus Input Current

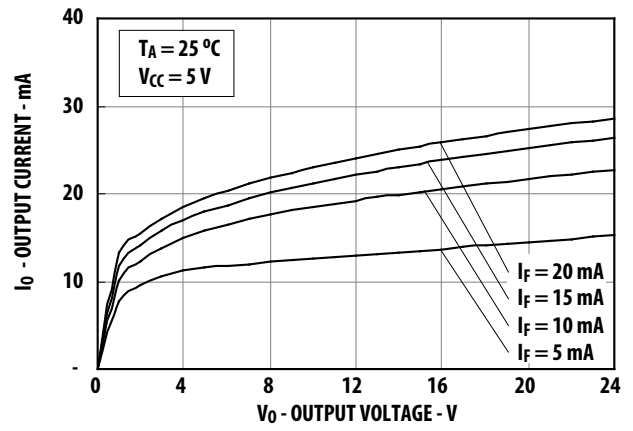

Figure 17. DC Pulse Transfer Characteristic

For product information and a complete list of distributors, please go to our web site: www.avagotech.com

Avago, Avago Technologies, and the A logo are trademarks of Avago Technologies in the United States and other countries. Data subject to change. Copyright © 2005-2014 Avago Technologies. All rights reserved. AV02-2223EN - October 24, 2014

