

## Feature

- 16V/6A,  $R_{DS(ON)} = 50\text{m}\Omega$  (MAX) @ $V_{GS} = 4.5\text{V}$ .  
 $R_{DS(ON)} = 55\text{m}\Omega$  (MAX) @ $V_{GS} = 2.5\text{V}$ .
- Super High dense cell design for extremely low  $R_{DS(ON)}$ .
- Reliable and Rugged .
- SC-59 for Surface Mount Package .

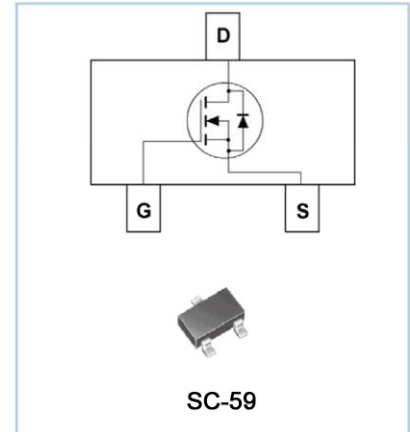

## Applications

- LI-ION Protection Circuit

## Absolute Maximum Ratings

$T_A=25^\circ\text{C}$  Unless Otherwise noted

Parameter	Symbol	Limit	Units
Drain-Source Voltage	$V_{DS}$	16	V
Gate-Source Voltage	$V_{GS}$	$\pm 12$	V
Drain Current-Continuous	$I_D$	6	A

## Electrical Characteristics

$T_A=25^\circ\text{C}$  Unless Otherwise noted

Parameter	Symbol	Test Conditions	Min	Typ.	Max	Units
<b>Off Characteristics</b>						
Drain to Source Breakdown Voltage	BVDSS	$V_{GS}=0\text{V}, I_D=250\mu\text{A}$	16	-	-	V
Zero-Gate Voltage Drain Current	$I_{DSS}$	$V_{DS}=6\text{V}, V_{GS}=0\text{V}$	-	-	1	$\mu\text{A}$
Gate Body Leakage Current, Forward	$I_{GSSF}$	$V_{GS}=12\text{V}, V_{DS}=0\text{V}$	-	-	300	nA
Gate Body Leakage Current, Reverse	$I_{GSSR}$	$V_{GS}=-12\text{V}, V_{DS}=0\text{V}$	-	-	-300	nA
<b>On Characteristics</b>						
Gate Threshold Voltage	$V_{GS(th)}$	$V_{GS}=V_{DS}, I_D=250\mu\text{A}$	0.4	-	1.3	V
Static Drain-source	$R_{DS(ON)}$	$V_{GS}=4.5\text{V}, I_D=6.0\text{A}$	-	40	50	$\text{m}\Omega$
On-Resistance		$V_{GS}=2.5\text{V}, I_D=5.2\text{A}$	-	44	55	$\text{m}\Omega$
<b>Drain-Source Diode Characteristics and Maximum Ratings</b>						
Drain-Source Diode Forward Voltage	VSD	$V_{GS}=0\text{V}, I_S=1.5\text{A}$			1.2	V



## N-Channel Enhancement Mode MOSFET Typical Characteristics

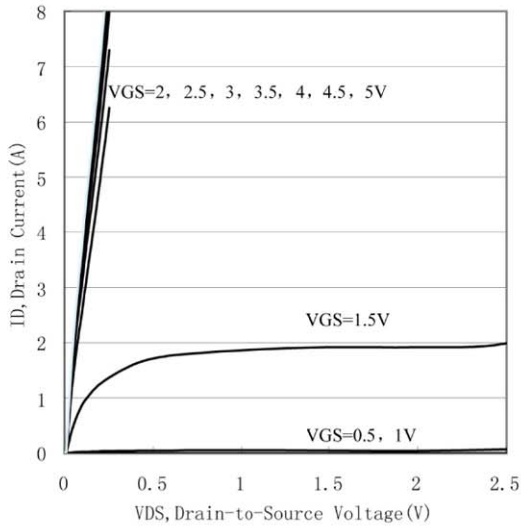

Figure 1. Output Characteristics

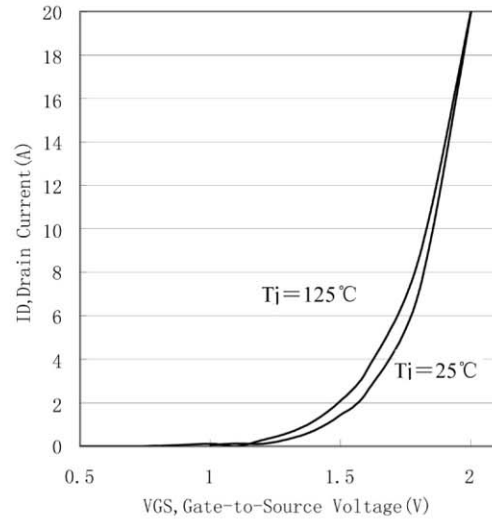

Figure 2. Transfer Characteristics

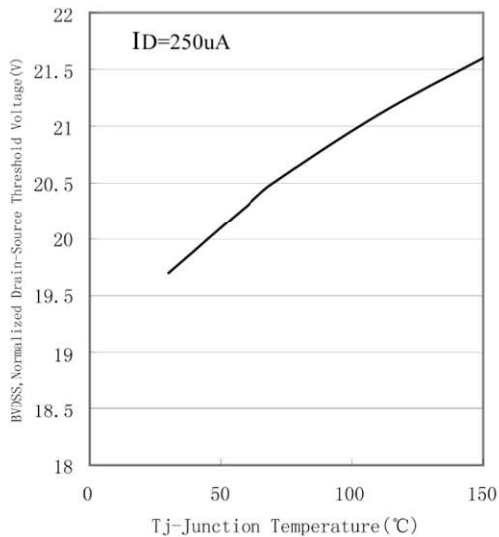

Figure 3. Breakdown Voltage Variation with Temperature

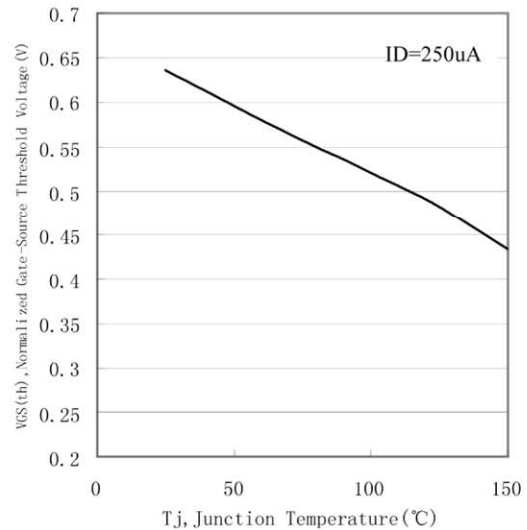
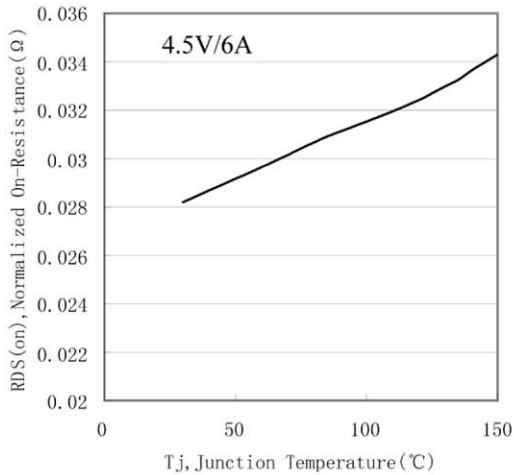

Figure 4. Gate Threshold Variation with Temperature



## N-Channel Enhancement Mode MOSFET Typical Characteristics



**Figure 5. On-Resistance Variation with Temperature**

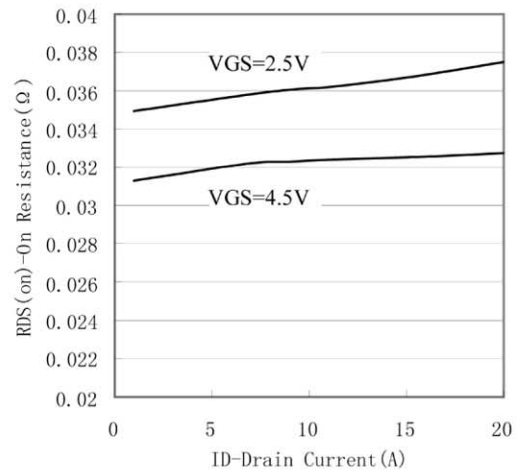

**Figure 6. On-Resistance vs. Drain Current**

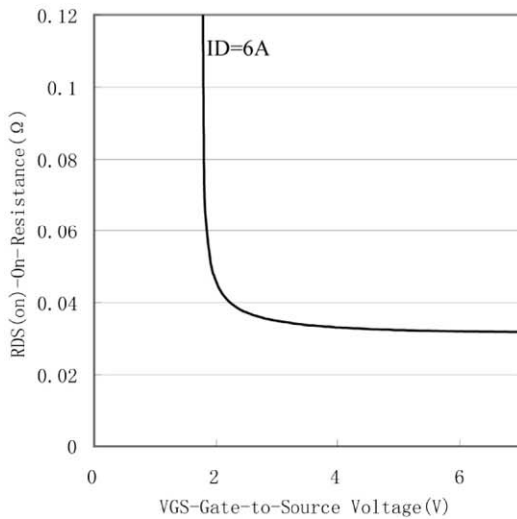

**Figure 7. On-Resistance vs. Gate-to-Source Voltage**

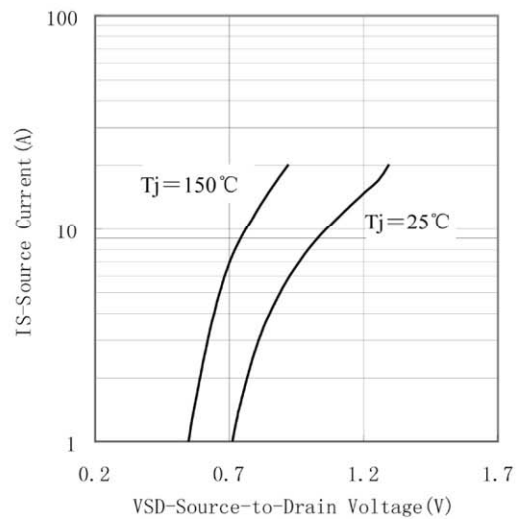

**Figure 8. Source-Drain Diode Forward Voltage**



Package Outline Dimensions (UNIT: mm)

SC-59

