

**Whole case service supplier
about Lithium battery overload**

锂电池过载连接全案服务供应商

锂电好搭档、动力无极限

AMASS

ABOUT AMASS

关于艾迈斯

15年如一日关注锂电池充放电过载连接，产品广泛应用于锂电池模型（无人机、穿越机、遥控模型等）、锂电池代步工具（平衡车、扭扭车、独轮车、滑板车、踏板车等）、锂电池电动工具、电动自行车、储能设备、智能机器人、消费电子等领域。服务于全球近360家品牌企业，产品出口63个国家与地区。

15 years like a day only pay attention to the connection about the lithium battery charging and discharging overload. Products are widely used on the lithium model (drone\runner\RC model etc.); lithium travel tool (balance car\scooters); lithium electric tool\electric bicycle\energy storage\intelligent robot\consumer electronics. Around the world AMASS serve nearly 360 brand enterprise and export 63 countries and zone.

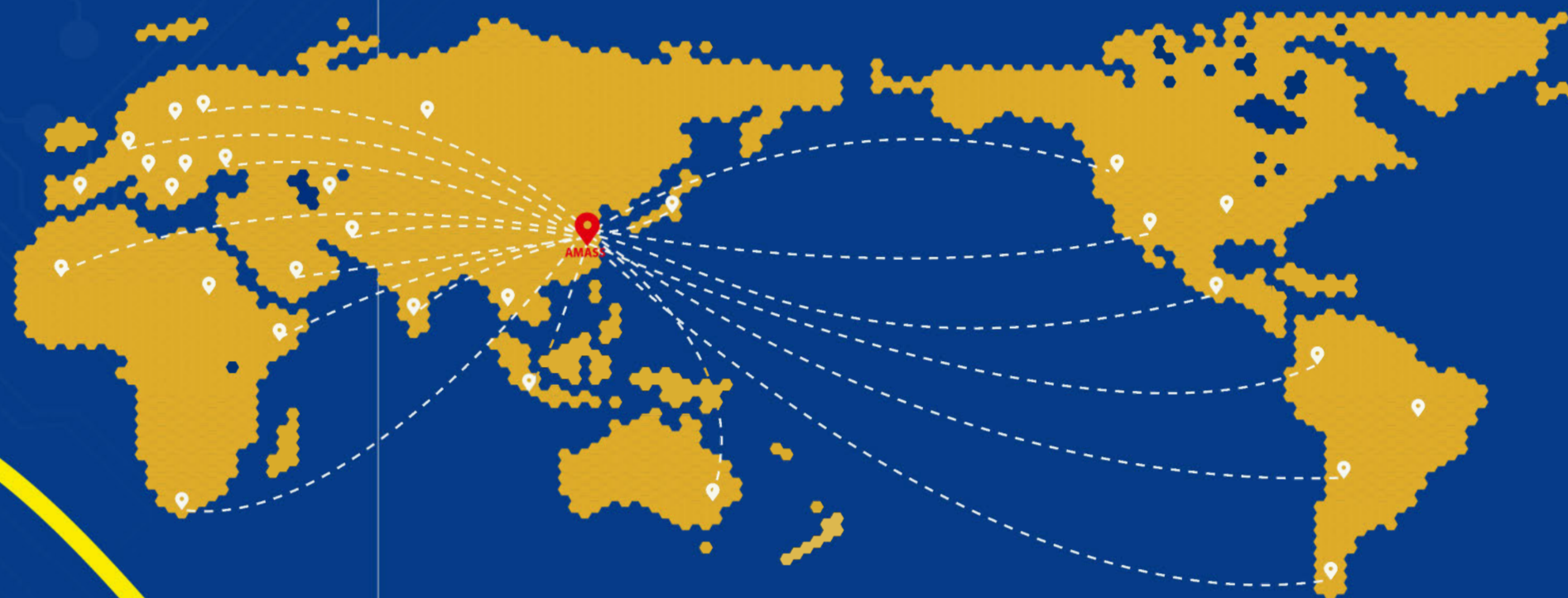

OUR ADVANTAGE

我们的优势



PRODUCING

大生产

近20000平方米自有厂房，拥有注塑、冲压、
组装、焊接等多条生产流水线。

Nearly 20000M2 working place, punch/inject/assemble/
soldering, several line work.

HUGE STOCK

大库存

大数据式销售、满足客户交期，特别是专利产品，做到24小
小时内发货。

Bulk data support which can help AMASS makes the right stock
and satisfy customers' request. Especially the patent products
that we can deliver out the goods within 24 hours!



PATENT

多专利

AMASS拥有近50项接头国家专利证书。
We have nearly 50 patent in hand.



CERTIFICATION

多认证

AMASS拥有近50项接头国家专利证书。
We passed the ISO/CE/UL/ROSH and so on.



XT30

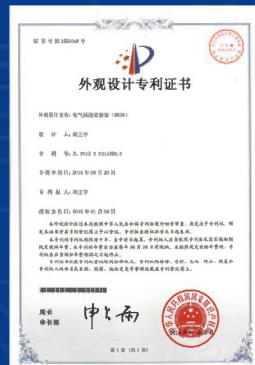

MR30



XT60

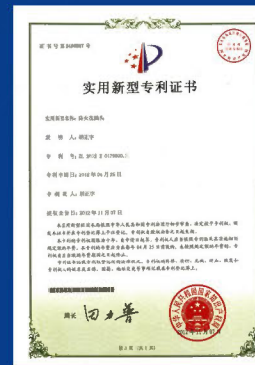

MT60



XT90



XT150

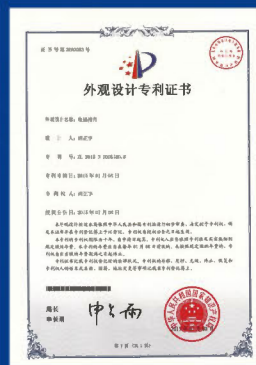

AS150

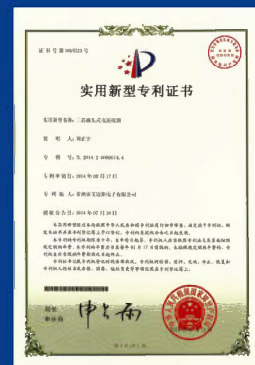

T插

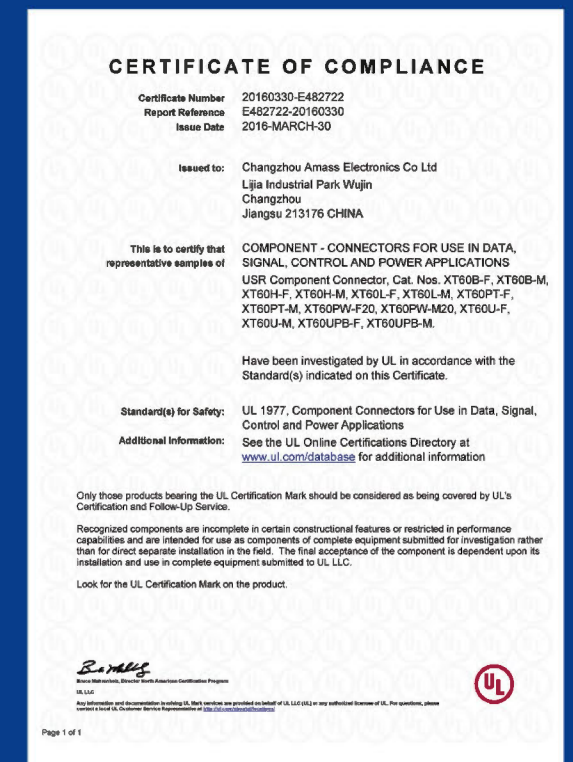
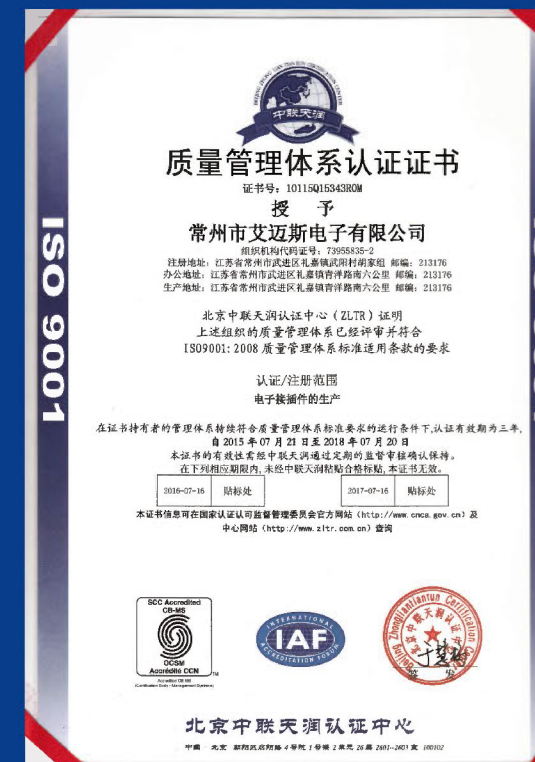

CONNECTORS USE

锂电池设备动力接头应用

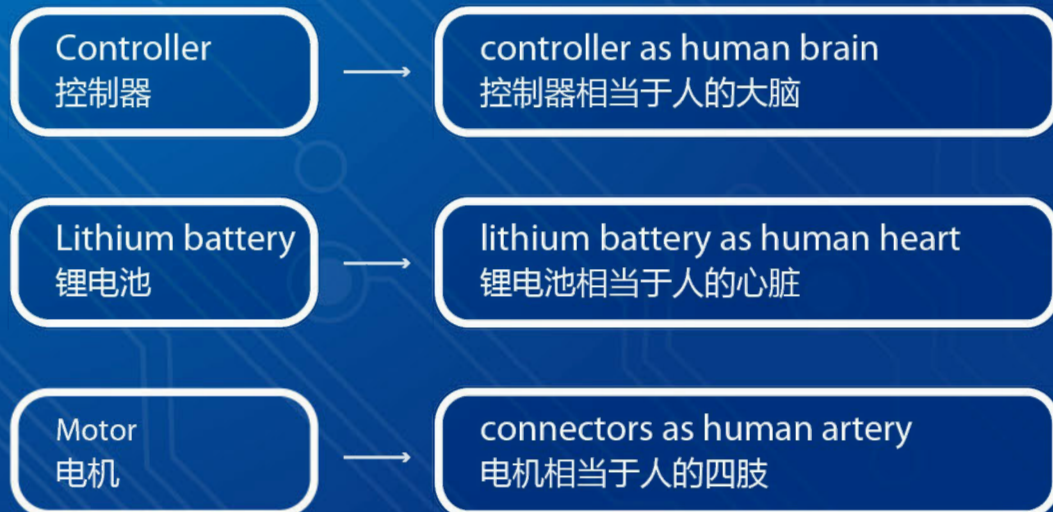

ONE STOP R & D CAPABILITY

一站式研发能力

研发能力，15年如一日，专注于过载连接的技术与经验，只要您提出概念、想法、使用参数等，或者我司现有产品的不足，就可快速的为您提供清晰完整的解决方案。

We focus on the connectors 15 years as one day. You only need to give us an idea、data sheet or even the imagination that we can provide you the whole solution.

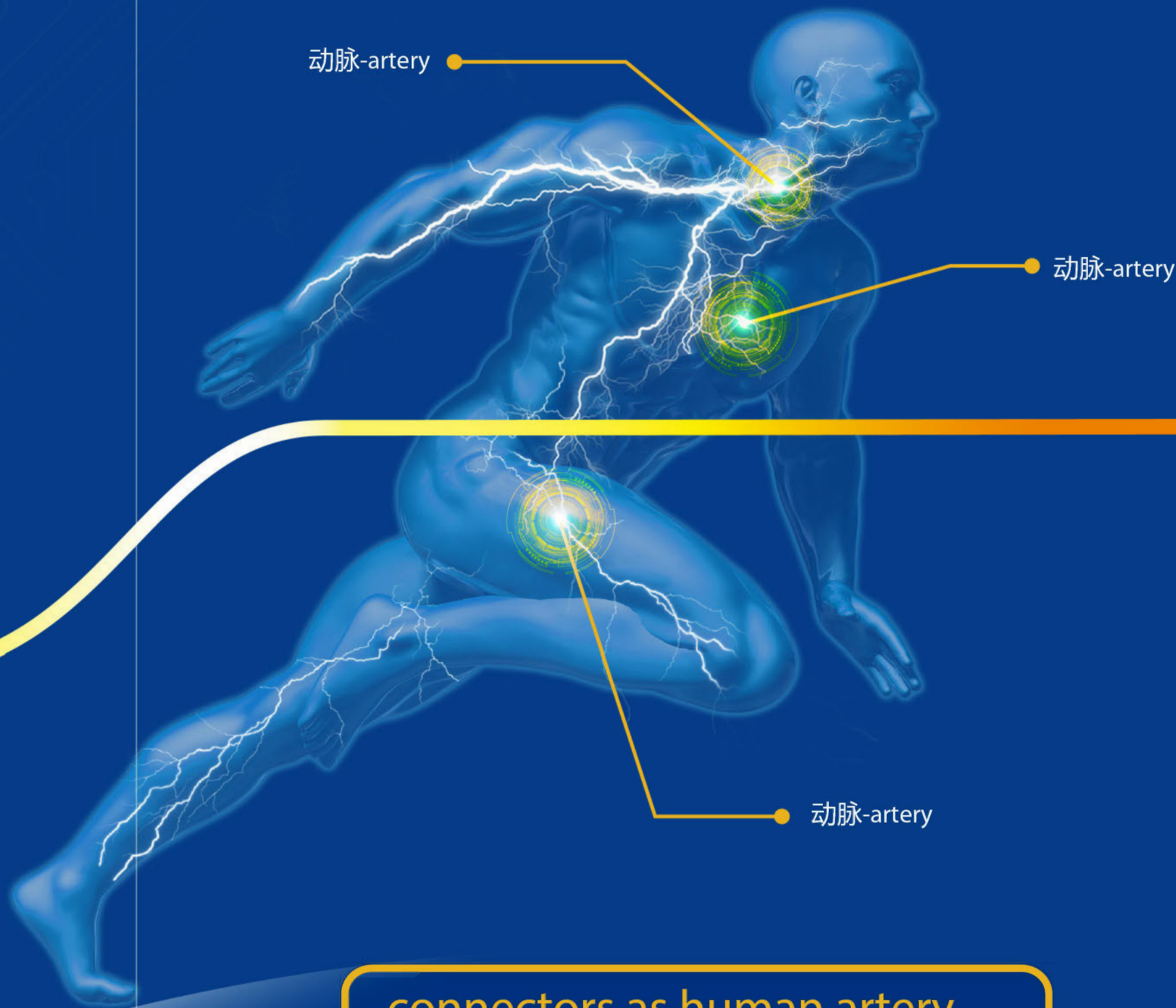



connectors as human artery
动力接头相当于人的大动脉

AMASS MORE SAFETY CONNECTORS
艾迈斯，更安全的动力接头

<p>XT 系列 XT SERIES</p>			<p>P13-P26</p>
<p>AS 系列 AS SERIES</p>		<p>多用于锂电池、控制器、充电器三者的动力连接</p>	<p>P27-P28</p>
<p>AM 系列 AM SERIES</p>		<p>BATTERY、CONTROLLER AND CHARGER CONNECTION</p>	<p>P29-P32</p>
<p>EC 系列 EC SERIES</p>			<p>P33-P35</p>

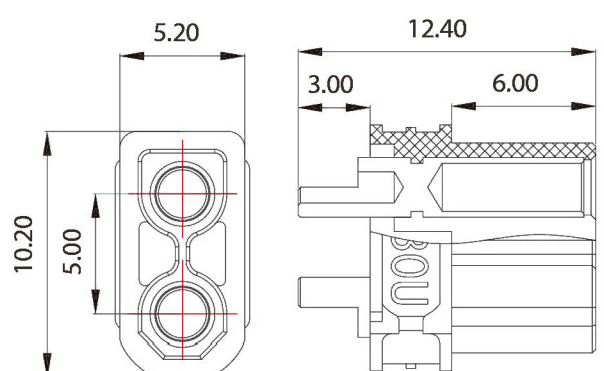
<p>MR 系列 MR SERIES</p>			<p>P36-P38</p>
<p>MT 系列 MT SERIES</p>		<p>多用于电机与控制器的动力连接 MOTOR AND CONTROLLER CONNECTION</p>	<p>P39-P40</p>
<p>SH 系列 SH SERIES</p>			<p>P41-P42</p>
<p>GC 系列 GC SERIES</p>		<p>多用于锂电池、控制器、电机、充电器四者的动力连接 BATTERY、CONTROLLER、MOTOR、CHARGER CONNECTION</p>	<p>P43-P58</p>
<p>其他 OTHERS</p>		<p>线束加工服务 CABLE SERVICE</p>	<p>P59-P60</p>

产品型号 (Item No) XT30U-F	产品材质及基本参数 (Material & Parameter)			
	产品型号 Item No.	XT30U-F	接触电阻 CR	0.70mΩ
	颜色 COLOR	2 3	额定电压	DC 500V
专利号 (Patent) 201630055144.7	金属材质 Metal Material	铜镀金 Brass Gold Plated	额定电流 RC	15A
客户图纸 (Drawing)	绝缘材质 Plastic Material	PA	瞬时电流 MC	30A
	阻燃等级 FR LEVEL	UL94 V0	推荐使用次数 USE TIMES	1000 TIMES
	推荐应用 Recommend USE	电池 BATTERY	推荐线规 Cable SPEC.	18AWG
	安规认证 CERTIFICATION	CE/UL	工作温度 TEMPERATURE	-20°C to 120°C

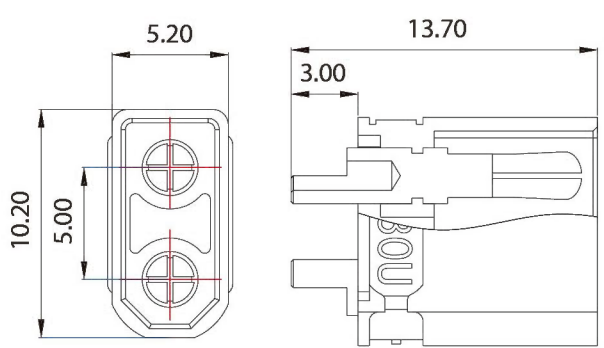
产品型号 (Item No) XT30U-M	产品材质及基本参数 (Material & Parameter)			
	产品型号 Item No.	XT30U-M	接触电阻 CR	0.70mΩ
	颜色 COLOR	2 3	额定电压	DC 500V
专利号 (Patent) 201630055143.2	金属材质 Metal Material	铜镀金 Brass Gold Plated	额定电流 RC	15A
客户图纸 (Drawing)	绝缘材质 Plastic Material	PA	瞬时电流 MC	30A
	阻燃等级 FR LEVEL	UL94 V0	推荐使用次数 USE TIMES	1000 TIMES
	推荐应用 Recommend USE	控制器 CONTROLLER	推荐线规 Cable SPEC.	18AWG
	安规认证 CERTIFICATION	CE/UL	工作温度 TEMPERATURE	-20°C to 120°C

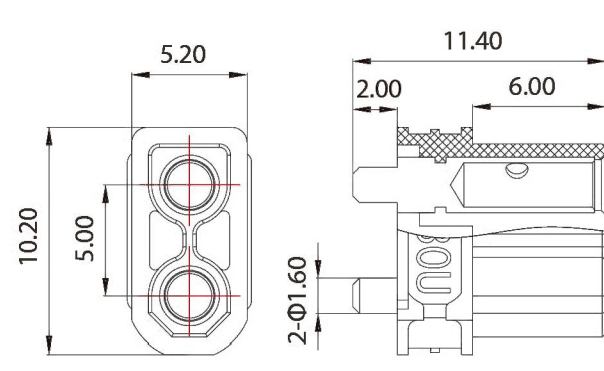
产品型号 (Item No) XT30UPB-F	产品材质及基本参数 (Material & Parameter)			
	产品型号 Item No.	XT30UPB-F	接触电阻 CR	0.65mΩ
	颜色 COLOR	3	额定电压	DC 500V
专利号 (Patent) 201630055132.4	金属材质 Metal Material	铜镀金 Brass Gold Plated	额定电流 RC	15A
客户图纸 (Drawing)	绝缘材质 Plastic Material	PA	瞬时电流 MC	30A
	阻燃等级 FR LEVEL	UL94 V0	推荐使用次数 USE TIMES	1000 TIMES
	推荐应用 Recommend USE	电池 BATTERY	推荐线规 Cable SPEC.	PCB
	安规认证 CERTIFICATION	CE/UL	工作温度 TEMPERATURE	-20°C to 120°C

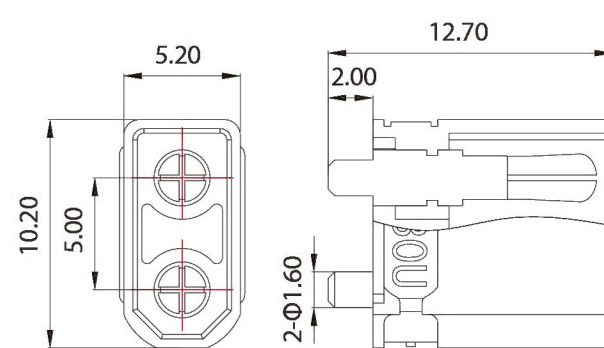
产品型号 (Item No) XT30UPB-M	产品材质及基本参数 (Material & Parameter)			
	产品型号 Item No.	XT30UPB-M	接触电阻 CR	0.65mΩ
	颜色 COLOR	3	额定电压	DC 500V
专利号 (Patent) 201630055129.2	金属材质 Metal Material	铜镀金 Brass Gold Plated	额定电流 RC	15A
客户图纸 (Drawing)	绝缘材质 Plastic Material	PA	瞬时电流 MC	30A
	阻燃等级 FR LEVEL	UL94 V0	推荐使用次数 USE TIMES	1000 TIMES
	推荐应用 Recommend USE	控制器/充电器 CONTROLLER/ CHARGER	推荐线规 Cable SPEC.	PCB
	安规认证 CERTIFICATION	CE/UL	工作温度 TEMPERATURE	-20°C to 120°C

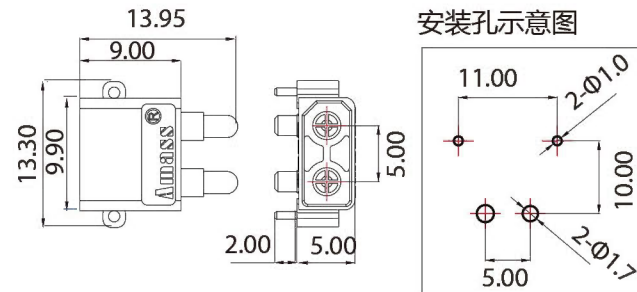
产品型号 (Item No) XT30PW-F	产品材质及基本参数 (Material & Parameter)			
	产品型号 Item No.	XT30PW-F	接触电阻 CR	0.80mΩ
	颜色 COLOR	3	额定电压	DC 500V
专利号 (Patent) 201530416577.6	金属材质 Metal Material	铜镀金 Brass Gold Plated	额定电流 RC	15A
客户图纸 (Drawing)	绝缘材质 Plastic Material	PA	瞬时电流 MC	30A
	阻燃等级 FR LEVEL	UL94 V0	推荐使用次数 USE TIMES	1000 TIMES
	推荐应用 Recommend USE	电池 BATTERY	推荐线规 Cable SPEC.	PCB
	安规认证 CERTIFICATION	CE/UL	工作温度 TEMPERATURE	-20°C to 120°C

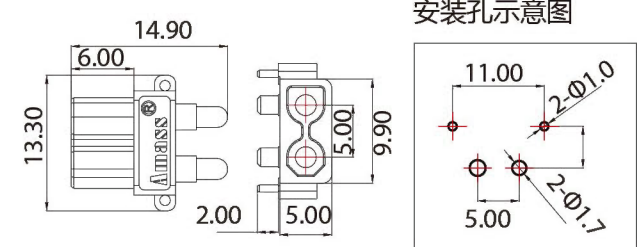
产品型号 (Item No) XT30PW-M	产品材质及基本参数 (Material & Parameter)			
	产品型号 Item No.	XT30PW-M	接触电阻 CR	0.80mΩ
	颜色 COLOR	3	额定电压	DC 500V
专利号 (Patent) 201530416577.6	金属材质 Metal Material	铜镀金 Brass Gold Plated	额定电流 RC	15A
客户图纸 (Drawing)	绝缘材质 Plastic Material	PA	瞬时电流 MC	30A
	阻燃等级 FR LEVEL	UL94 V0	推荐使用次数 USE TIMES	1000 TIMES
	推荐应用 Recommend USE	控制器/充电器 CONTROLLER/ CHARGER	推荐线规 Cable SPEC.	PCB
	安规认证 CERTIFICATION	CE/UL	工作温度 TEMPERATURE	-20°C to 120°C

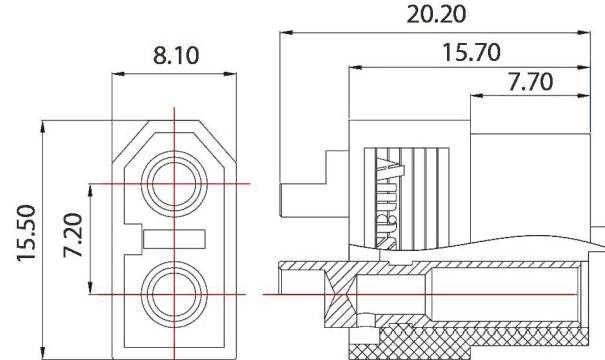
产品型号 (Item No) XT60-F	产品材质及基本参数 (Material & Parameter)			
	产品型号 Item No.	XT60-F	接触电阻 CR	0.55mΩ
	颜色 COLOR	2 3	额定电压	DC 500V
专利号 (Patent) 200920043518.8	金属材质 Metal Material	铜镀金 Brass Gold Plated	额定电流 RC	30A
客户图纸 (Drawing)	绝缘材质 Plastic Material	PA	瞬时电流 MC	60A
	阻燃等级 FR LEVEL	UL94 V0	推荐使用次数 USE TIMES	1000 TIMES
	推荐应用 Recommend USE	电池 BATTERY	推荐线规 Cable SPEC.	12AWG
	安规认证 CERTIFICATION	---	工作温度 TEMPERATURE	-20°C to 120°C

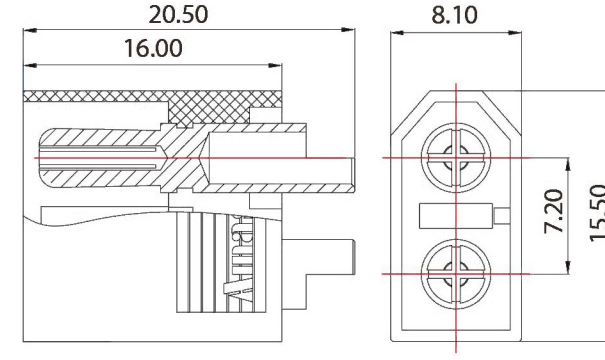
产品型号 (Item No) XT60-M	产品材质及基本参数 (Material & Parameter)			
	产品型号 Item No.	XT60-M	接触电阻 CR	0.55mΩ
	颜色 COLOR	2 3	额定电压	DC 500V
专利号 (Patent) 200920043518.8	金属材质 Metal Material	铜镀金 Brass Gold Plated	额定电流 RC	30A
客户图纸 (Drawing)	绝缘材质 Plastic Material	PA	瞬时电流 MC	60A
	阻燃等级 FR LEVEL	UL94 V0	推荐使用次数 USE TIMES	1000 TIMES
	推荐应用 Recommend USE	控制器 CONTROLLER	推荐线规 Cable SPEC.	12AWG
	安规认证 CERTIFICATION	---	工作温度 TEMPERATURE	-20°C to 120°C

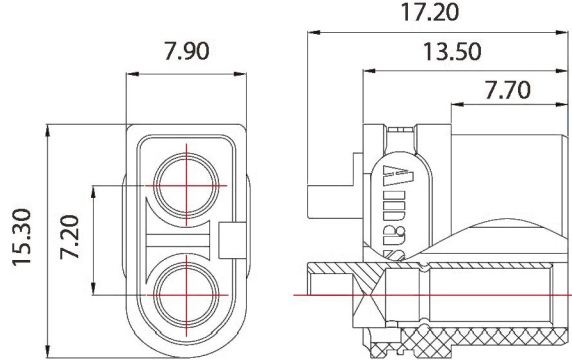
产品型号 (Item No) XT60U-F	产品材质及基本参数 (Material & Parameter)			
	产品型号 Item No.	XT60U-F	接触电阻 CR	0.45mΩ
专利号 (Patent) 201530451153.3	颜色 COLOR	2 3	额定电压 RC	DC 500V
客户图纸 (Drawing)	金属材质 Metal Material	铜镀金 Brass Gold Plated	额定电流 RC	30A
	绝缘材质 Plastic Material	PA	瞬时电流 MC	60A
	阻燃等级 FR LEVEL	UL94 V0	推荐使用次数 USE TIMES	1000 TIMES
	推荐应用 Recommend USE	电池 BATTERY	推荐线规 Cable SPEC.	12AWG
	安规认证 CERTIFICATION	CE/UL	工作温度 TEMPERATURE	-20°C to 120°C

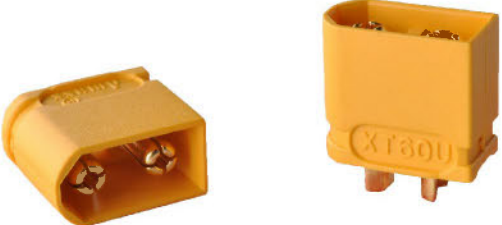
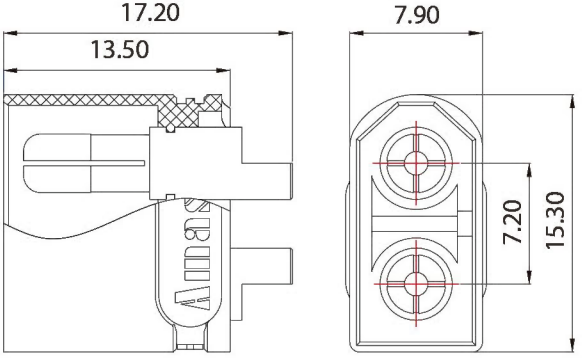
产品型号 (Item No) XT60U-M	产品材质及基本参数 (Material & Parameter)			
	产品型号 Item No.	XT60U-M	接触电阻 CR	0.45mΩ
专利号 (Patent) 201530451153.3	颜色 COLOR	2 3	额定电压 RC	DC 500V
客户图纸 (Drawing)	金属材质 Metal Material	铜镀金 Brass Gold Plated	额定电流 RC	30A
	绝缘材质 Plastic Material	PA	瞬时电流 MC	60A
	阻燃等级 FR LEVEL	UL94 V0	推荐使用次数 USE TIMES	1000 TIMES
	推荐应用 Recommend USE	控制器 CONTROLLER	推荐线规 Cable SPEC.	12AWG
	安规认证 CERTIFICATION	CE/UL	工作温度 TEMPERATURE	-20°C to 120°C

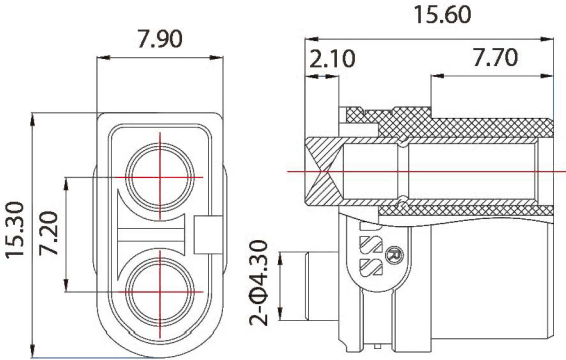
产品型号 (Item No) XT60UPB-F	产品材质及基本参数 (Material & Parameter)			
	产品型号 Item No.	XT60UPB-F	接触电阻 CR	0.30mΩ
专利号 (Patent) ---	颜色 COLOR	3	额定电压 RC	DC 500V
客户图纸 (Drawing)	金属材质 Metal Material	铜镀金 Brass Gold Plated	额定电流 RC	30A
	绝缘材质 Plastic Material	PA	瞬时电流 MC	60A
	阻燃等级 FR LEVEL	UL94 V0	推荐使用次数 USE TIMES	1000 TIMES
	推荐应用 Recommend USE	电池 BATTERY	推荐线规 Cable SPEC.	PCB
	安规认证 CERTIFICATION	CE/UL	工作温度 TEMPERATURE	-20°C to 120°C

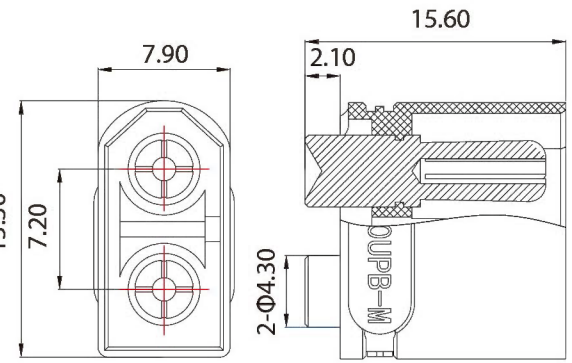
产品型号 (Item No) XT60UPB-M	产品材质及基本参数 (Material & Parameter)			
	产品型号 Item No.	XT60UPB-M	接触电阻 CR	0.30mΩ
专利号 (Patent) ---	颜色 COLOR	3	额定电压 RC	DC 500V
客户图纸 (Drawing)	金属材质 Metal Material	铜镀金 Brass Gold Plated	额定电流 RC	30A
	绝缘材质 Plastic Material	PA	瞬时电流 MC	60A
	阻燃等级 FR LEVEL	UL94 V0	推荐使用次数 USE TIMES	1000 TIMES
	推荐应用 Recommend USE	控制器/充电器 CONTROLLER/ CHARGER	推荐线规 Cable SPEC.	PCB
	安规认证 CERTIFICATION	CE/UL	工作温度 TEMPERATURE	-20°C to 120°C

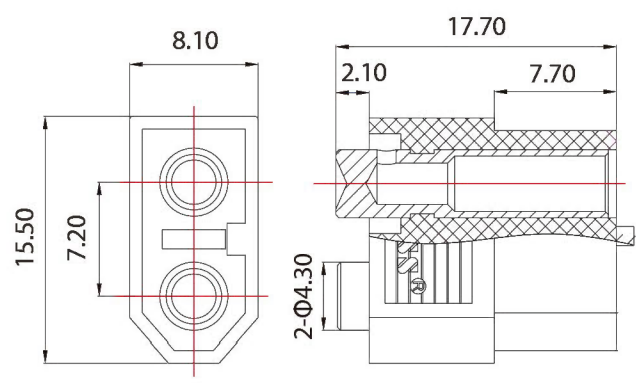
产品型号 (Item No) XT60PW-F	产品材质及基本参数 (Material & Parameter)			
	产品型号 Item No.	XT60PW-F	接触电阻 CR	0.50mΩ
	颜色 COLOR	3	额定电压	DC 500V
专利号 (Patent) 201530511914.X	金属材质 Metal Material	铜镀金 Brass Gold Plated	额定电流 RC	30A
客户图纸 (Drawing)	绝缘材质 Plastic Material	PA	瞬时电流 MC	60A
	阻燃等级 FR LEVEL	UL94 V0	推荐使用次数 USE TIMES	1000 TIMES
	推荐应用 Recommend USE	电池 BATTERY	推荐线规 Cable SPEC.	PCB
	安规认证 CERTIFICATION	CE/UL	工作温度 TEMPERATURE	-20°C to 120°C

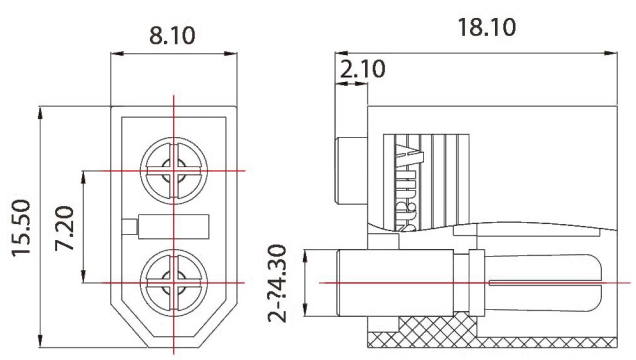
产品型号 (Item No) XT60PW-M	产品材质及基本参数 (Material & Parameter)			
	产品型号 Item No.	XT60PW-M	接触电阻 CR	0.50mΩ
	颜色 COLOR	3	额定电压	DC 500V
专利号 (Patent) 201530511914.X	金属材质 Metal Material	铜镀金 Brass Gold Plated	额定电流 RC	30A
客户图纸 (Drawing)	绝缘材质 Plastic Material	PA	瞬时电流 MC	60A
	阻燃等级 FR LEVEL	UL94 V0	推荐使用次数 USE TIMES	1000 TIMES
	推荐应用 Recommend USE	控制器/充电器 CONTROLLER/ CHARGER	推荐线规 Cable SPEC.	PCB
	安规认证 CERTIFICATION	CE/UL	工作温度 TEMPERATURE	-20°C to 120°C

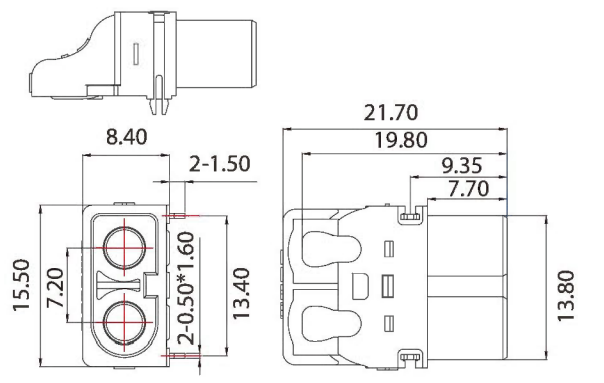
产品型号 (Item No) XT60PT-F	产品材质及基本参数 (Material & Parameter)			
	产品型号 Item No.	XT60PT-F	接触电阻 CR	0.50mΩ
	颜色 COLOR	3	额定电压	DC 500V
专利号 (Patent) 201630023590.X	金属材质 Metal Material	铜镀金 Brass Gold Plated	额定电流 RC	30A
客户图纸 (Drawing)	绝缘材质 Plastic Material	PA	瞬时电流 MC	60A
	阻燃等级 FR LEVEL	UL94 V0	推荐使用次数 USE TIMES	1000 TIMES
	推荐应用 Recommend USE	电池 BATTERY	推荐线规 Cable SPEC.	PCB
	安规认证 CERTIFICATION	CE/UL	工作温度 TEMPERATURE	-20°C to 120°C

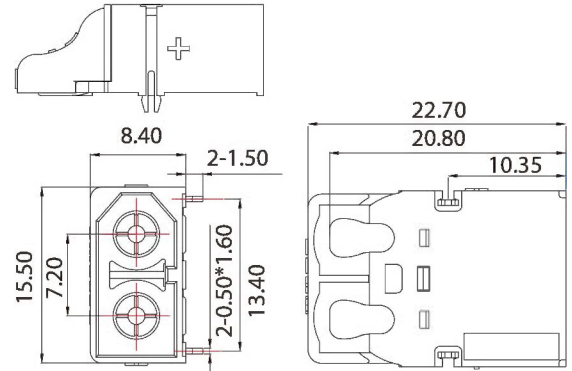
产品型号 (Item No) XT60PT-M	产品材质及基本参数 (Material & Parameter)			
	产品型号 Item No.	XT60PT-M	接触电阻 CR	0.50mΩ
	颜色 COLOR	3	额定电压	DC 500V
专利号 (Patent) 201630023587.8	金属材质 Metal Material	铜镀金 Brass Gold Plated	额定电流 RC	30A
客户图纸 (Drawing)	绝缘材质 Plastic Material	PA	瞬时电流 MC	60A
	阻燃等级 FR LEVEL	UL94 V0	推荐使用次数 USE TIMES	1000 TIMES
	推荐应用 Recommend USE	控制器/充电器 CONTROLLER/ CHARGER	推荐线规 Cable SPEC.	PCB
	安规认证 CERTIFICATION	CE/UL	工作温度 TEMPERATURE	-20°C to 120°C

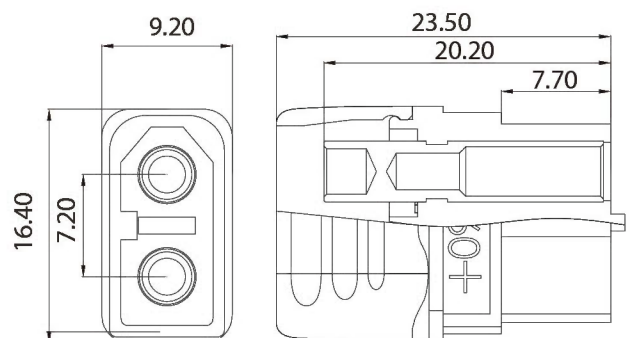
产品型号 (Item No) XT60H-F	产品材质及基本参数 (Material & Parameter)			
	产品型号 Item No.	XT60H-F	接触电阻 CR	0.50mΩ
	颜色 COLOR	3	额定电压	DC 500V
专利号 (Patent) 201530348205.4	金属材质 Metal Material	铜镀金 Brass Gold Plated	额定电流 RC	30A
客户图纸 (Drawing)	绝缘材质 Plastic Material	PA	瞬时电流 MC	60A
	阻燃等级 FR LEVEL	UL94 V0	推荐使用次数 USE TIMES	1000 TIMES
	推荐应用 Recommend USE	电池 BATTERY	推荐线规 Cable SPEC.	12AWG
	安规认证 CERTIFICATION	CE/UL	工作温度 TEMPERATURE	-20°C to 120°C

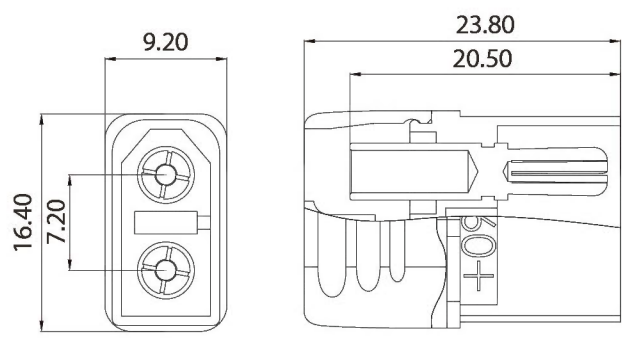
产品型号 (Item No) XT60H-M	产品材质及基本参数 (Material & Parameter)			
	产品型号 Item No.	XT60H-M	接触电阻 CR	0.50mΩ
	颜色 COLOR	3	额定电压	DC 500V
专利号 (Patent) 201530348205.4	金属材质 Metal Material	铜镀金 Brass Gold Plated	额定电流 RC	30A
客户图纸 (Drawing)	绝缘材质 Plastic Material	PA	瞬时电流 MC	60A
	阻燃等级 FR LEVEL	UL94 V0	推荐使用次数 USE TIMES	1000 TIMES
	推荐应用 Recommend USE	控制器 CONTROLLER	推荐线规 Cable SPEC.	12AWG
	安规认证 CERTIFICATION	CE/UL	工作温度 TEMPERATURE	-20°C to 120°C

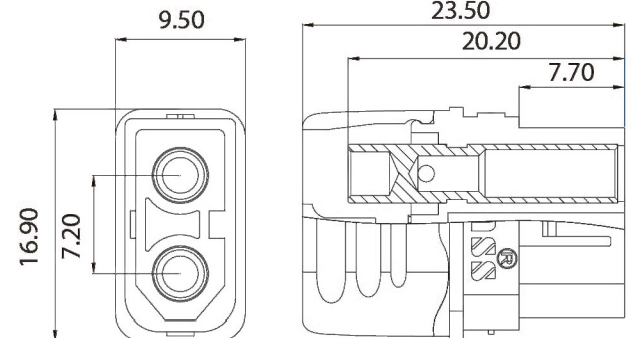
产品型号 (Item No) XT60L-F	产品材质及基本参数 (Material & Parameter)			
	产品型号 Item No.	XT60L-F	接触电阻 CR	0.50mΩ
	颜色 COLOR	3	额定电压	DC 500V
专利号 (Patent) 201520067495.X	金属材质 Metal Material	铜镀金 Brass Gold Plated	额定电流 RC	30A
客户图纸 (Drawing)	绝缘材质 Plastic Material	PA	瞬时电流 MC	60A
	阻燃等级 FR LEVEL	UL94 V0	推荐使用次数 USE TIMES	1000 TIMES
	推荐应用 Recommend USE	电池 BATTERY	推荐线规 Cable SPEC.	12AWG
	安规认证 CERTIFICATION	CE/UL	工作温度 TEMPERATURE	-20°C to 120°C

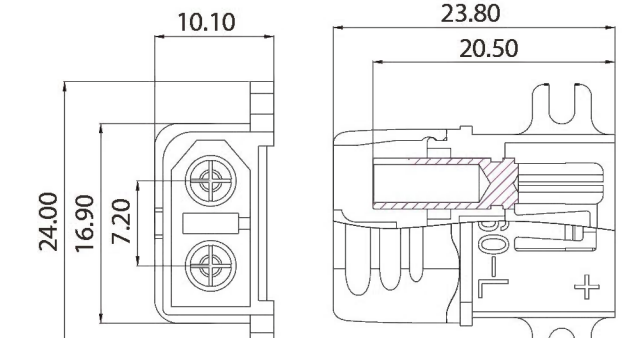
产品型号 (Item No) XT60L-M	产品材质及基本参数 (Material & Parameter)			
	产品型号 Item No.	XT60L-M	接触电阻 CR	0.50mΩ
	颜色 COLOR	3	额定电压	DC 500V
专利号 (Patent) 201520067495.X	金属材质 Metal Material	铜镀金 Brass Gold Plated	额定电流 RC	30A
客户图纸 (Drawing)	绝缘材质 Plastic Material	PA	瞬时电流 MC	60A
	阻燃等级 FR LEVEL	UL94 V0	推荐使用次数 USE TIMES	1000 TIMES
	推荐应用 Recommend USE	控制器/充电器 CONTROLLER/ CHARGER	推荐线规 Cable SPEC.	12AWG
	安规认证 CERTIFICATION	CE/UL	工作温度 TEMPERATURE	-20°C to 120°C

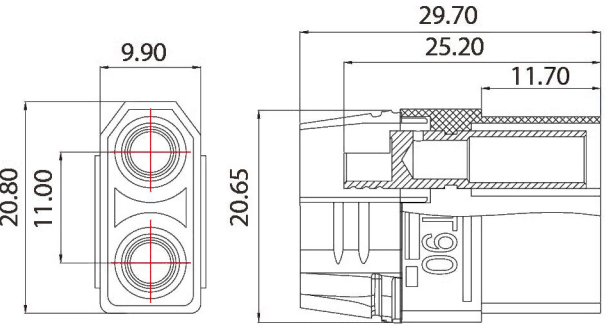
产品型号 (Item No) XT90H-F	产品材质及基本参数 (Material & Parameter)			
	产品型号 Item No.	XT90H-F	接触电阻 CR	0.30mΩ
	颜色 COLOR	2 3	额定电压	DC 500V
专利号 (Patent) 201220179912.6	金属材质 Metal Material	铜镀金 Brass Gold Plated	额定电流 RC	40A
客户图纸 (Drawing)	绝缘材质 Plastic Material	PA	瞬时电流 MC	90A
	阻燃等级 FR LEVEL	UL94 V0	推荐使用次数 USE TIMES	1000 TIMES
	推荐应用 Recommend USE	电池 BATTERY	推荐线规 Cable SPEC.	10AWG
	安规认证 CERTIFICATION	---	工作温度 TEMPERATURE	-20°C to 120°C

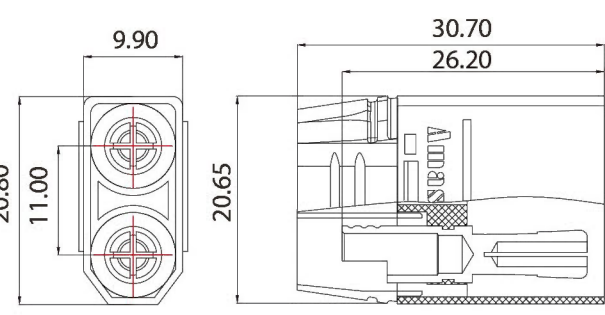
产品型号 (Item No) XT90H-M	产品材质及基本参数 (Material & Parameter)			
	产品型号 Item No.	XT90H-M	接触电阻 CR	0.30mΩ
	颜色 COLOR	2 3	额定电压	DC 500V
专利号 (Patent) 201220179912.6	金属材质 Metal Material	铜镀金 Brass Gold Plated	额定电流 RC	40A
客户图纸 (Drawing)	绝缘材质 Plastic Material	PA	瞬时电流 MC	90A
	阻燃等级 FR LEVEL	UL94 V0	推荐使用次数 USE TIMES	1000 TIMES
	推荐应用 Recommend USE	控制器/充电器 CONTROLLER/ CHARGER	推荐线规 Cable SPEC.	10AWG
	安规认证 CERTIFICATION	---	工作温度 TEMPERATURE	-20°C to 120°C

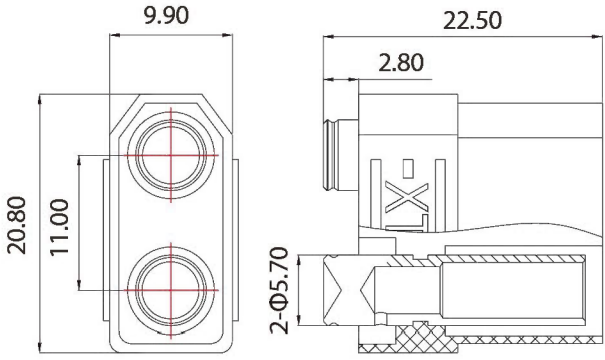
产品型号 (Item No) XT90PB-F	产品材质及基本参数 (Material & Parameter)			
	产品型号 Item No.	XT90PB-F	接触电阻 CR	0.30mΩ
	颜色 COLOR	3	额定电压	DC 500V
专利号 (Patent) ---	金属材质 Metal Material	铜镀金 Brass Gold Plated	额定电流 RC	40A
客户图纸 (Drawing)	绝缘材质 Plastic Material	PA	瞬时电流 MC	90A
	阻燃等级 FR LEVEL	UL94 V0	推荐使用次数 USE TIMES	1000 TIMES
	推荐应用 Recommend USE	电池 BATTERY	推荐线规 Cable SPEC.	PCB
	安规认证 CERTIFICATION	---	工作温度 TEMPERATURE	-20°C to 120°C

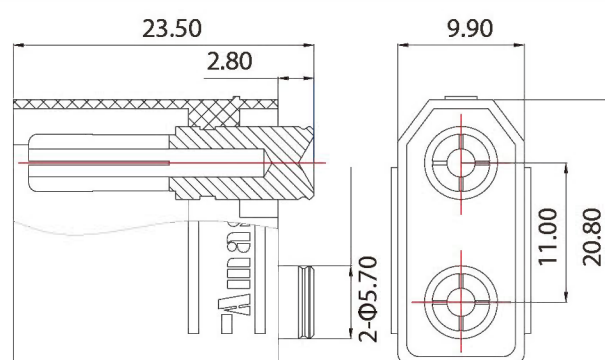

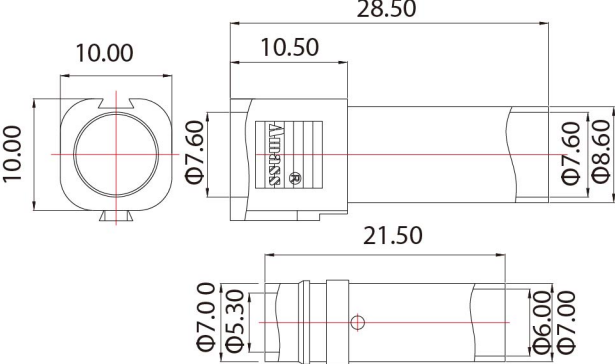
产品型号 (Item No) XT90PB-M	产品材质及基本参数 (Material & Parameter)			
	产品型号 Item No.	XT90PB-M	接触电阻 CR	0.30mΩ
	颜色 COLOR	3	额定电压	DC 500V
专利号 (Patent) ---	金属材质 Metal Material	铜镀金 Brass Gold Plated	额定电流 RC	40A
客户图纸 (Drawing)	绝缘材质 Plastic Material	PA	瞬时电流 MC	90A
	阻燃等级 FR LEVEL	UL94 V0	推荐使用次数 USE TIMES	1000 TIMES
	推荐应用 Recommend USE	控制器/充电器 CONTROLLER/ CHARGER	推荐线规 Cable SPEC.	PCB
	安规认证 CERTIFICATION	---	工作温度 TEMPERATURE	-20°C to 120°C

产品型号 (Item No) XT150-F	产品材质及基本参数 (Material & Parameter)		
	产品型号 Item No.	XT150-F	接触电阻 CR 0.20mΩ
专利号 (Patent) 201030165732.9	颜色 COLOR	1 2 5	额定电压 DC 500V
客户图纸 (Drawing)	金属材质 Metal Material	铜镀金 Brass Gold Plated	额定电流 RC 60A
	绝缘材质 Plastic Material	PA	瞬时电流 MC 130A
	阻燃等级 FR LEVEL	UL94 V0	推荐使用次数 USE TIMES 1000 TIMES
	推荐应用 Recommend USE	电池 BATTERY	推荐线规 Cable SPEC. 8AWG
	安规认证 CERTIFICATION	---	工作温度 TEMPERATURE -20°C to 120°C

产品型号 (Item No) XT150-M	产品材质及基本参数 (Material & Parameter)		
	产品型号 Item No.	XT150-M	接触电阻 CR 0.20mΩ
专利号 (Patent) 201030165735.2	颜色 COLOR	1 2 5	额定电压 DC 500V
客户图纸 (Drawing)	金属材质 Metal Material	铜镀金 Brass Gold Plated	额定电流 RC 60A
	绝缘材质 Plastic Material	PA	瞬时电流 MC 130A
	阻燃等级 FR LEVEL	UL94 V0	推荐使用次数 USE TIMES 1000 TIMES
	推荐应用 Recommend USE	控制器 CONTROLLER	推荐线规 Cable SPEC. 8AWG
	安规认证 CERTIFICATION	---	工作温度 TEMPERATURE -20°C to 120°C

01

无人机、穿越机领域 Drones Industry





无人机
Drones

穿越机
Runner

02

遥控模型领域 Remote Control Model



遥控车
car

遥控船
boat

遥控飞机
plane

03



电动车辆领域 Electric Vehicle

平衡车
Balance car

独轮车
unicycle

扭扭车
Twisting car



电动车
Electric cars

电动踏板车
Electric scooter

电动滑板车
Electric scooter

04

其他领域 Other Fields

光仪储能
Optical storage

摄像机
The camera



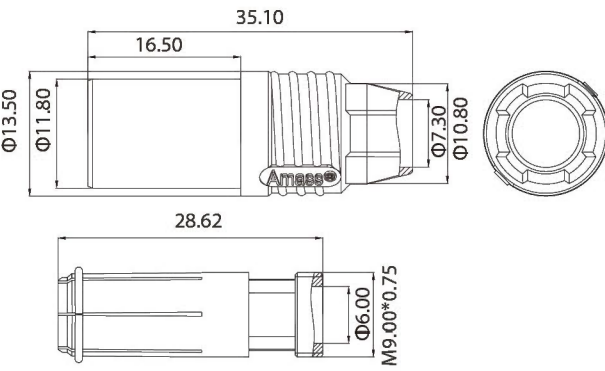

太阳能路灯
Solar street lamps

割草机
The lawn mower

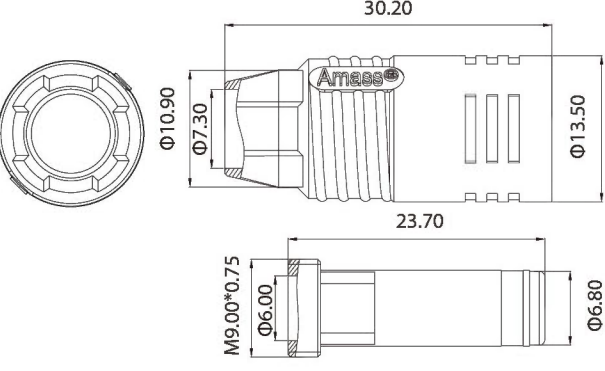
产品型号 (Item No) AS150-F	产品材质及基本参数 (Material & Parameter)			
	产品型号 Item No.	AS150-F	接触电阻 CR	0.2mΩ
专利号 (Patent) ---	颜色 COLOR	1 2	额定电压	DC 500V
客户图纸 (Drawing)	金属材质 Metal Material	铜镀金 Brass Gold Plated	额定电流 RC	70A
	绝缘材质 Plastic Material	PA	瞬时电流 MC	150A
	阻燃等级 FR LEVEL	UL94 V0	推荐使用次数 USE TIMES	1000 TIMES
	推荐应用 Recommend USE	电池 BATTERY	推荐线规 Cable SPEC.	6AWG
	安规认证 CERTIFICATION	---	工作温度 TEMPERATURE	-20°C to 120°C

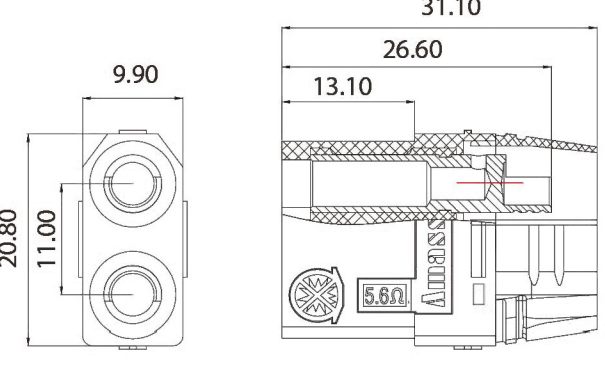
产品型号 (Item No) AS150-M	产品材质及基本参数 (Material & Parameter)			
	产品型号 Item No.	AS150-M	接触电阻 CR	0.2mΩ
专利号 (Patent) 201420553770.4	颜色 COLOR	1 2	额定电压	DC 500V
客户图纸 (Drawing)	金属材质 Metal Material	铜镀金 Brass Gold Plated	额定电流 RC	70A
	绝缘材质 Plastic Material	PA	瞬时电流 MC	150A
	阻燃等级 FR LEVEL	UL94 V0	推荐使用次数 USE TIMES	1000 TIMES
	推荐应用 Recommend USE	控制器 CONTROLLER	推荐线规 Cable SPEC.	6AWG
	安规认证 CERTIFICATION	---	工作温度 TEMPERATURE	-20°C to 120°C

产品型号 (Item No) XT90S-F	产品材质及基本参数 (Material & Parameter)			
	产品型号 Item No.	XT90S-F	接触电阻 CR	0.56mΩ
专利号 (Patent) 201420181100.4	颜色 COLOR	3	额定电压	DC 500V
客户图纸 (Drawing)	金属材质 Metal Material	铜镀金 Brass Gold Plated	额定电流 RC	40A
	绝缘材质 Plastic Material	PA	瞬时电流 MC	90A
	阻燃等级 FR LEVEL	UL94 V0	推荐使用次数 USE TIMES	1000 TIMES
	推荐应用 Recommend USE	电池 BATTERY	推荐线规 Cable SPEC.	10AWG
	安规认证 CERTIFICATION	---	工作温度 TEMPERATURE	-20°C to 120°C

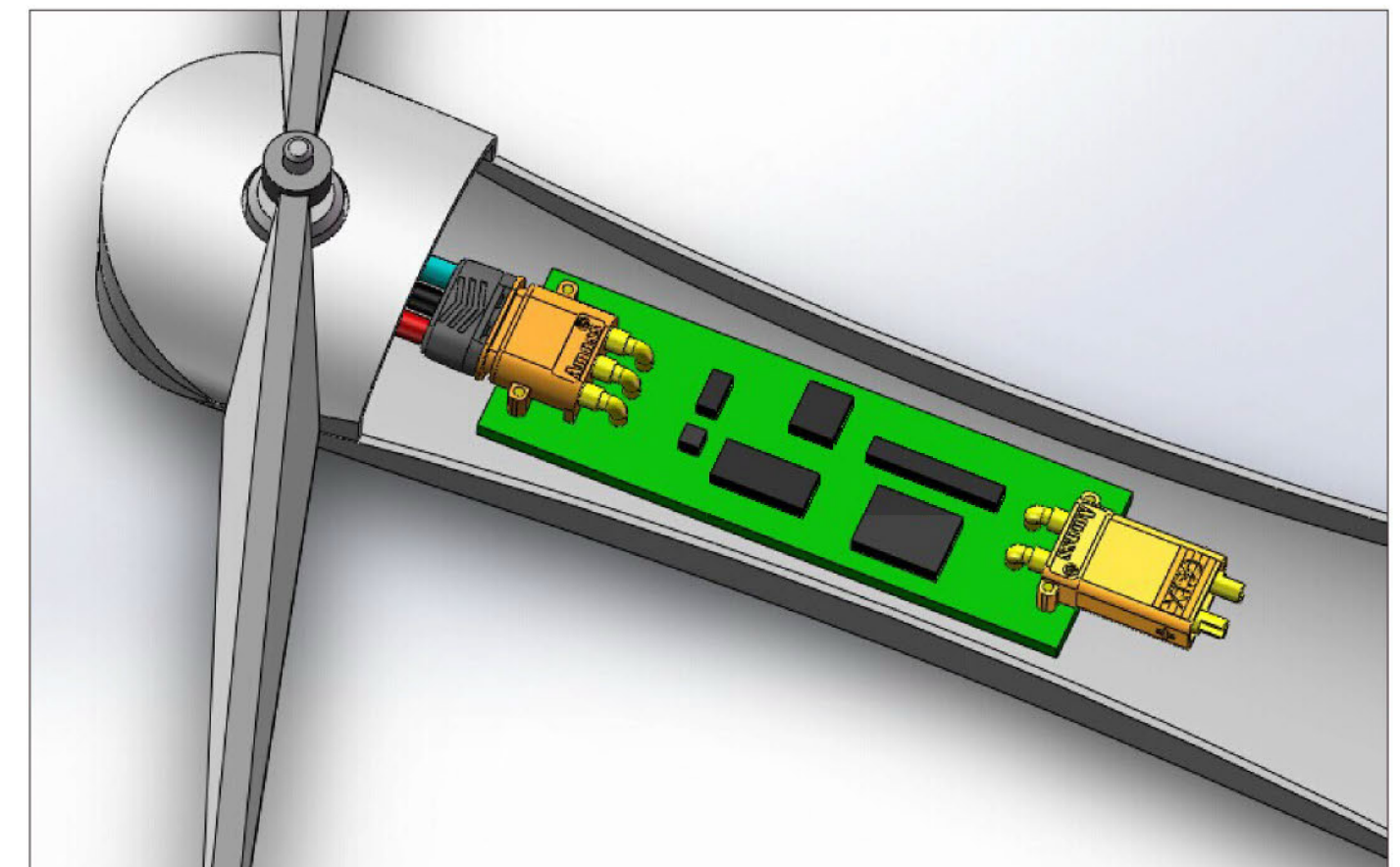

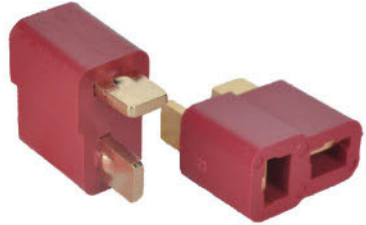
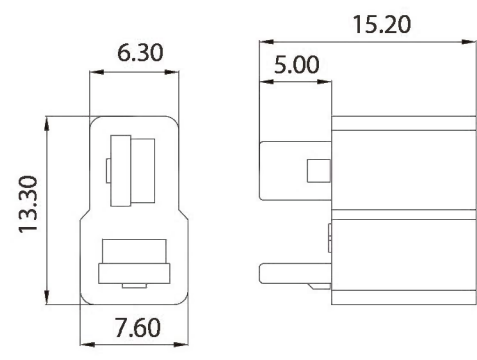

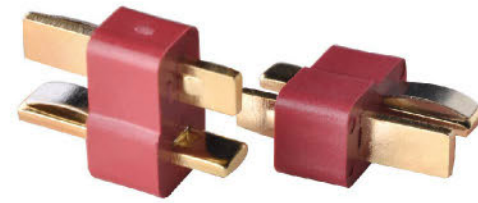
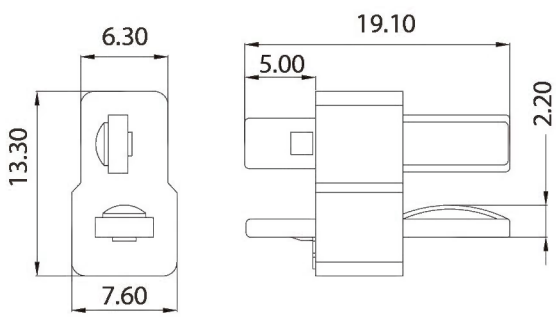
产品型号 (Item No) AM-1015-F	产品材质及基本参数 (Material & Parameter)			
	产品型号 Item No.	AM-1015-F	接触电阻 CR	0.45mΩ
	颜色 COLOR	1 2	额定电压	DC 500V
专利号 (Patent) ---	金属材料 Metal Material	铜镀金 Brass Gold Plated	额定电流 RC	25A
客户图纸 (Drawing)	绝缘材质 Plastic Material	PA	瞬时电流 MC	50A
	阻燃等级 FR LEVEL	UL94 V0	推荐使用次数 USE TIMES	1000 TIMES
	推荐应用 Recommend USE	电池 BATTERY	推荐线规 Cable SPEC.	12AWG
	安规认证 CERTIFICATION	---	工作温度 TEMPERATURE	-20°C to 120°C

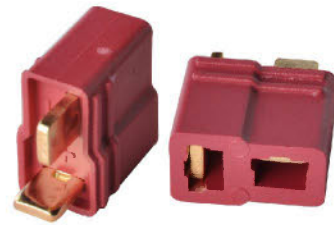
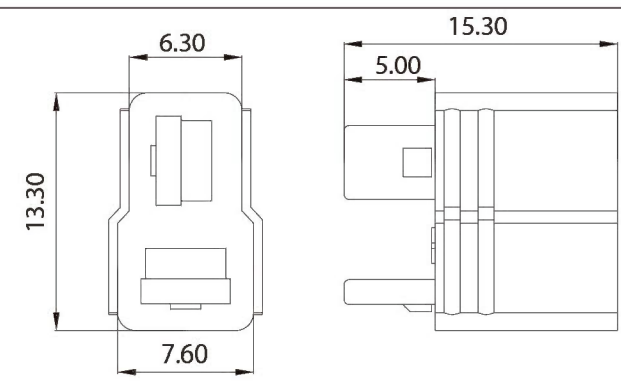
产品型号 (Item No) AM-1015-M	产品材质及基本参数 (Material & Parameter)			
	产品型号 Item No.	AM-1015-M	接触电阻 CR	0.45mΩ
	颜色 COLOR	1 2	额定电压	DC 500V
专利号 (Patent) ---	金属材料 Metal Material	铜镀金 Brass Gold Plated	额定电流 RC	25A
客户图纸 (Drawing)	绝缘材质 Plastic Material	PA	瞬时电流 MC	50A
	阻燃等级 FR LEVEL	UL94 V0	推荐使用次数 USE TIMES	1000 TIMES
	推荐应用 Recommend USE	控制器 CONTROLLER	推荐线规 Cable SPEC.	12AWG
	安规认证 CERTIFICATION	---	工作温度 TEMPERATURE	-20°C to 120°C

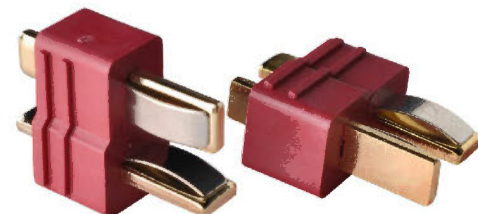
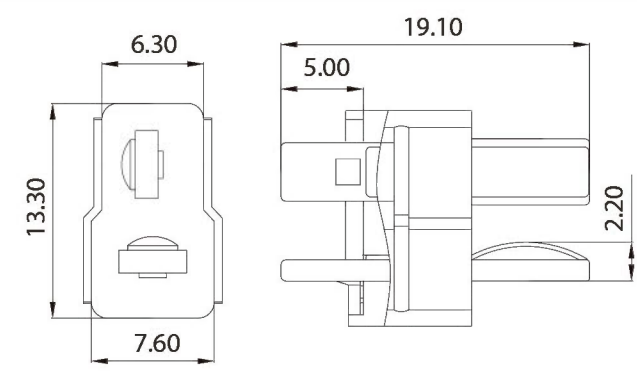
产品型号 (Item No) AM-1015B-F	产品材质及基本参数 (Material & Parameter)			
	产品型号 Item No.	AM-1015B-F	接触电阻 CR	0.45mΩ
	颜色 COLOR	1 2	额定电压	DC 500V
专利号 (Patent) ---	金属材料 Metal Material	铜镀金 Brass Gold Plated	额定电流 RC	25A
客户图纸 (Drawing)	绝缘材质 Plastic Material	PA	瞬时电流 MC	50A
	阻燃等级 FR LEVEL	UL94 V0	推荐使用次数 USE TIMES	1000 TIMES
	推荐应用 Recommend USE	电池 BATTERY	推荐线规 Cable SPEC.	12AWG
	安规认证 CERTIFICATION	---	工作温度 TEMPERATURE	-20°C to 120°C

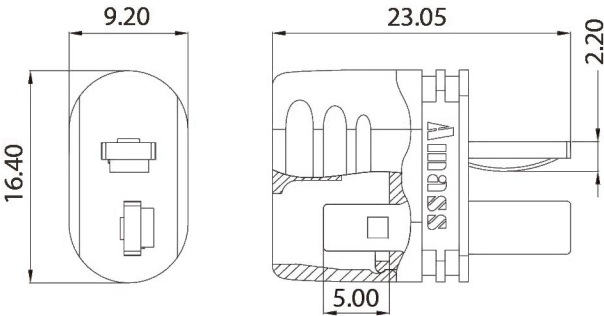
产品型号 (Item No) AM-1015B-M	产品材质及基本参数 (Material & Parameter)			
	产品型号 Item No.	AM-1015B-M	接触电阻 CR	0.45mΩ
	颜色 COLOR	1 2	额定电压	DC 500V
专利号 (Patent) ---	金属材料 Metal Material	铜镀金 Brass Gold Plated	额定电流 RC	25A
客户图纸 (Drawing)	绝缘材质 Plastic Material	PA	瞬时电流 MC	50A
	阻燃等级 FR LEVEL	UL94 V0	推荐使用次数 USE TIMES	1000 TIMES
	推荐应用 Recommend USE	控制器 CONTROLLER	推荐线规 Cable SPEC.	12AWG
	安规认证 CERTIFICATION	---	工作温度 TEMPERATURE	-20°C to 120°C

产品型号 (Item No) AM-1015E-F		产品材质及基本参数 (Material & Parameter)			
		产品型号 Item No.	AM-1015E-F	接触电阻 CR	0.45mΩ
		颜色 COLOR	1	额定电压	DC 500V
专利号 (Patent) 201530005180.8		金属材质 Metal Material	铜镀金 Brass Gold Plated	额定电流 RC	25A
客户图纸 (Drawing)		绝缘材质 Plastic Material	PA	瞬时电流 MC	50A
		阻燃等级 FR LEVEL	UL94 V0	推荐使用次数 USE TIMES	1000 TIMES
		推荐应用 Recommend USE	电池 BATTERY	推荐线规 Cable SPEC.	12AWG
		安规认证 CERTIFICATION	---	工作温度 TEMPERATURE	-20°C to 120°C

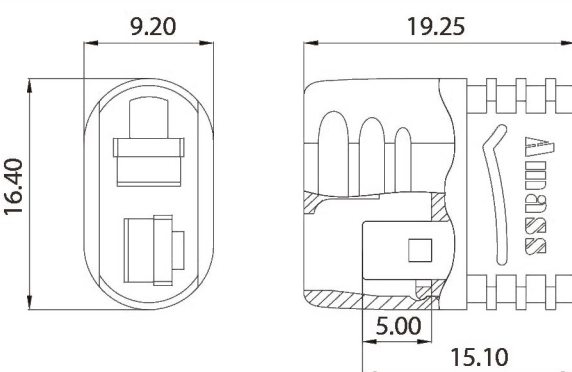
产品型号 (Item No) AM-1015E-M		产品材质及基本参数 (Material & Parameter)			
		产品型号 Item No.	AM-1015E-M	接触电阻 CR	0.45mΩ
		颜色 COLOR	1	额定电压	DC 500V
专利号 (Patent) 201530005180.8		金属材质 Metal Material	铜镀金 Brass Gold Plated	额定电流 RC	25A
客户图纸 (Drawing)		绝缘材质 Plastic Material	PA	瞬时电流 MC	50A
		阻燃等级 FR LEVEL	UL94 V0	推荐使用次数 USE TIMES	1000 TIMES
		推荐应用 Recommend USE	控制器 CONTROLLER	推荐线规 Cable SPEC.	12AWG
		安规认证 CERTIFICATION	---	工作温度 TEMPERATURE	-20°C to 120°C

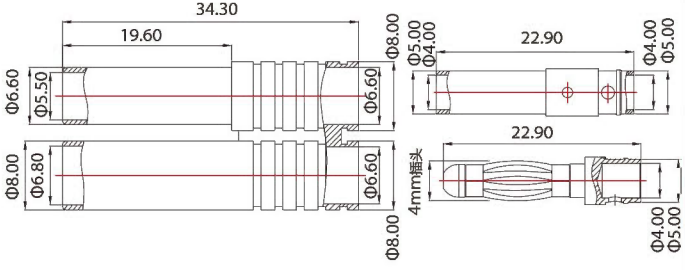
产品型号 (Item No) AM-1009L		产品材质及基本参数 (Material & Parameter)			
		产品型号 Item No.	AM-1009L	接触电阻 CR	0.65mΩ
		颜色 COLOR	1	额定电压	DC 500V
专利号 (Patent) ---		金属材质 Metal Material	铜镀金 Brass Gold Plated	额定电流 RC	32A
客户图纸 (Drawing)		绝缘材质 Plastic Material	PA	瞬时电流 MC	70A
		阻燃等级 FR LEVEL	UL94 V0	推荐使用次数 USE TIMES	1000 TIMES
		推荐应用 Recommend USE	电池/控制器 BATTERY/ CONTROLLER	推荐线规 Cable SPEC.	12AWG
		安规认证 CERTIFICATION	---	工作温度 TEMPERATURE	-20°C to 120°C

PRODUCTS SHOW
产品展示

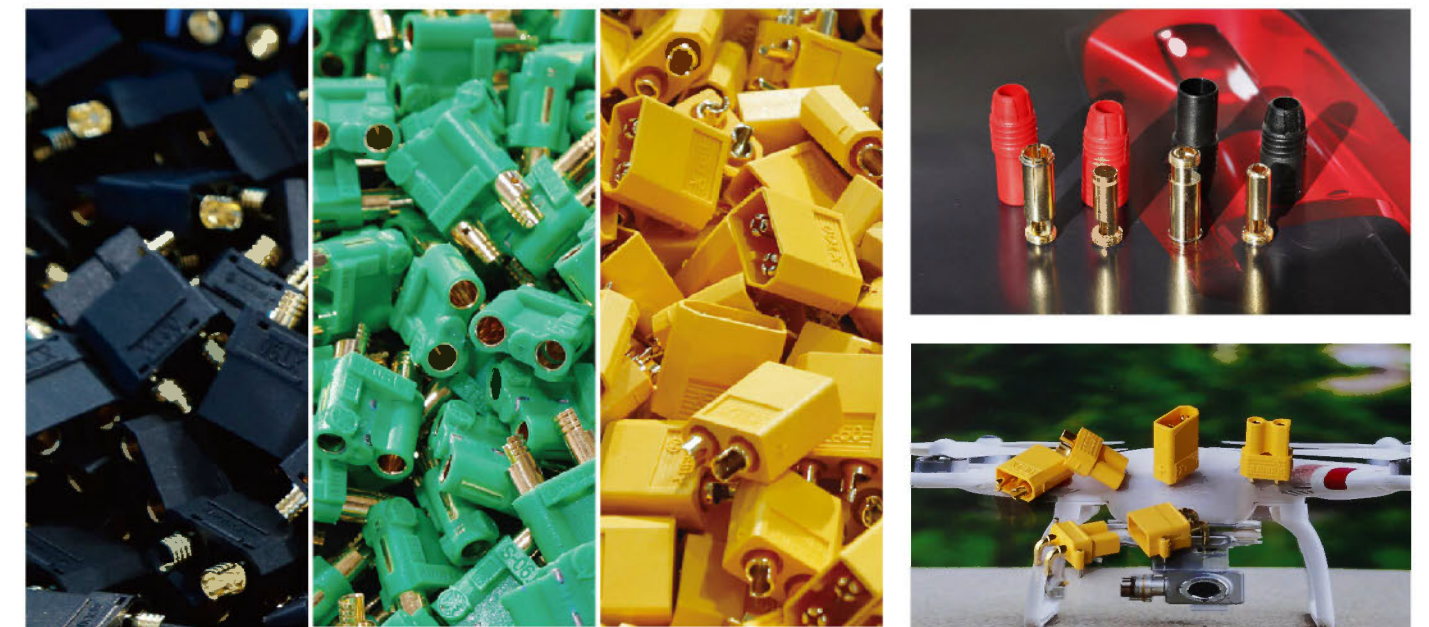



产品型号 (Item No) EC2-F	产品材质及基本参数 (Material & Parameter)			
	产品型号 Item No.	EC2-F	接触电阻 CR	0.80mΩ
	颜色 COLOR	5	额定电压	DC 500V
专利号 (Patent) ---	金属材质 Metal Material	铜镀金 Brass Gold Plated	额定电流 RC	15A
客户图纸 (Drawing)	绝缘材质 Plastic Material	PA	瞬时电流 MC	30A
	阻燃等级 FR LEVEL	UL94 V0	推荐使用次数 USE TIMES	1000 TIMES
	推荐应用 Recommend USE	电池 BATTERY	推荐线规 Cable SPEC.	18AWG
	安规认证 CERTIFICATION	---	工作温度 TEMPERATURE	-20°C to 120°C

产品型号 (Item No) EC2-M	产品材质及基本参数 (Material & Parameter)			
	产品型号 Item No.	EC2-M	接触电阻 CR	0.80mΩ
	颜色 COLOR	5	额定电压	DC 500V
专利号 (Patent) ---	金属材质 Metal Material	铜镀金 Brass Gold Plated	额定电流 RC	15A
客户图纸 (Drawing)	绝缘材质 Plastic Material	PA	瞬时电流 MC	30A
	阻燃等级 FR LEVEL	UL94 V0	推荐使用次数 USE TIMES	1000 TIMES
	推荐应用 Recommend USE	控制器 CONTROLLER	推荐线规 Cable SPEC.	18AWG
	安规认证 CERTIFICATION	---	工作温度 TEMPERATURE	-20°C to 120°C

产品型号 (Item No) EC3-F	产品材质及基本参数 (Material & Parameter)			
	产品型号 Item No.	EC3-F	接触电阻 CR	0.60mΩ
	颜色 COLOR	5	额定电压	DC 500V
专利号 (Patent) ---	金属材质 Metal Material	铜镀金 Brass Gold Plated	额定电流 RC	25A
客户图纸 (Drawing)	绝缘材质 Plastic Material	PA	瞬时电流 MC	50A
	阻燃等级 FR LEVEL	UL94 V0	推荐使用次数 USE TIMES	1000 TIMES
	推荐应用 Recommend USE	电池 BATTERY	推荐线规 Cable SPEC.	12AWG
	安规认证 CERTIFICATION	---	工作温度 TEMPERATURE	-20°C to 120°C

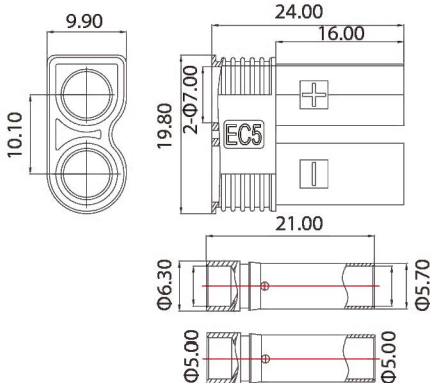
产品型号 (Item No) EC3-M	产品材质及基本参数 (Material & Parameter)			
	产品型号 Item No.	EC3-M	接触电阻 CR	0.60mΩ
	颜色 COLOR	5	额定电压	DC 500V
专利号 (Patent) ---	金属材质 Metal Material	铜镀金 Brass Gold Plated	额定电流 RC	25A
客户图纸 (Drawing)	绝缘材质 Plastic Material	PA	瞬时电流 MC	50A
	阻燃等级 FR LEVEL	UL94 V0	推荐使用次数 USE TIMES	1000 TIMES
	推荐应用 Recommend USE	控制器 CONTROLLER	推荐线规 Cable SPEC.	12AWG
	安规认证 CERTIFICATION	---	工作温度 TEMPERATURE	-20°C to 120°C

产品型号 (Item No) EC5-F	产品材质及基本参数 (Material & Parameter)			
	产品型号 Item No.	EC5-F	接触电阻 CR	0.40mΩ
	颜色 COLOR	5	额定电压	DC 500V
专利号 (Patent) ---	金属材料 Metal Material	铜镀金 Brass Gold Plated	额定电流 RC	40A
客户图纸 (Drawing)	绝缘材质 Plastic Material	PA	瞬时电流 MC	90A
	阻燃等级 FR LEVEL	UL94 V0	推荐使用次数 USE TIMES	1000 TIMES
	推荐应用 Recommend USE	电池 BATTERY	推荐线规 Cable SPEC.	10AWG
	安规认证 CERTIFICATION	---	工作温度 TEMPERATURE	-20°C to 120°C

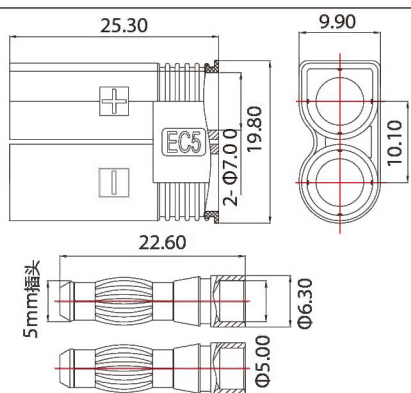
产品型号 (Item No) EC5-M	产品材质及基本参数 (Material & Parameter)			
	产品型号 Item No.	EC5-M	接触电阻 CR	0.40mΩ
	颜色 COLOR	5	额定电压	DC 500V
专利号 (Patent) ---	金属材料 Metal Material	铜镀金 Brass Gold Plated	额定电流 RC	40A
客户图纸 (Drawing)	绝缘材质 Plastic Material	PA	瞬时电流 MC	90A
	阻燃等级 FR LEVEL	UL94 V0	推荐使用次数 USE TIMES	1000 TIMES
	推荐应用 Recommend USE	控制器 CONTROLLER	推荐线规 Cable SPEC.	10AWG
	安规认证 CERTIFICATION	---	工作温度 TEMPERATURE	-20°C to 120°C

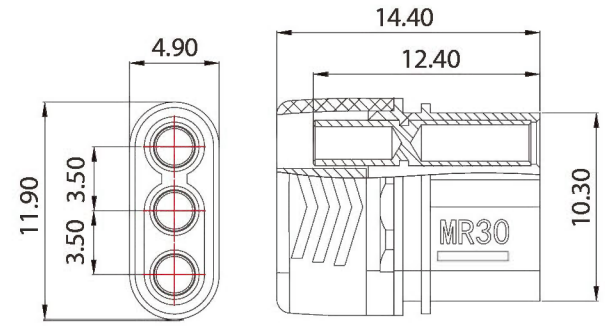
产品型号 (Item No) MR30-FB	产品材质及基本参数 (Material & Parameter)			
	产品型号 Item No.	MR30-FB	接触电阻 CR	0.70mΩ
	颜色 COLOR	3	额定电压	DC 500V
专利号 (Patent) 201530314656.6	金属材料 Metal Material	铜镀金 Brass Gold Plated	额定电流 RC	15A
客户图纸 (Drawing)	绝缘材质 Plastic Material	PA	瞬时电流 MC	30A
	阻燃等级 FR LEVEL	UL94 V0	推荐使用次数 USE TIMES	1000 TIMES
	推荐应用 Recommend USE	控制器 CONTROLLER	推荐线规 Cable SPEC.	16AWG
	安规认证 CERTIFICATION	CE/UL	工作温度 TEMPERATURE	-20°C to 120°C

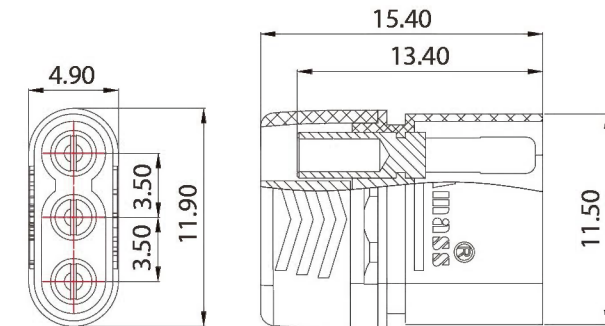

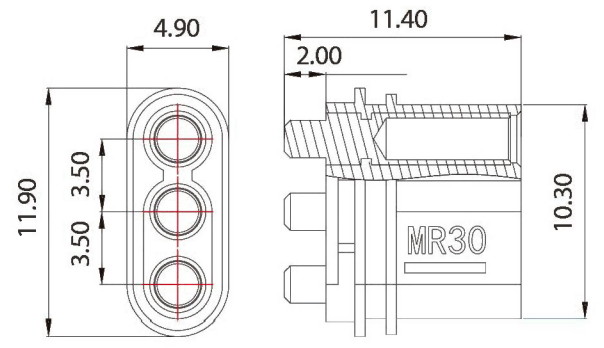
产品型号 (Item No) MR30-M	产品材质及基本参数 (Material & Parameter)			
	产品型号 Item No.	MR30-M	接触电阻 CR	0.70mΩ
	颜色 COLOR	3	额定电压	DC 500V
专利号 (Patent) 201530314656.6	金属材料 Metal Material	铜镀金 Brass Gold Plated	额定电流 RC	15A
客户图纸 (Drawing)	绝缘材质 Plastic Material	PA	瞬时电流 MC	30A
	阻燃等级 FR LEVEL	UL94 V0	推荐使用次数 USE TIMES	1000 TIMES
	推荐应用 Recommend USE	电机 MOTOR	推荐线规 Cable SPEC.	16AWG
	安规认证 CERTIFICATION	CE/UL	工作温度 TEMPERATURE	-20°C to 120°C

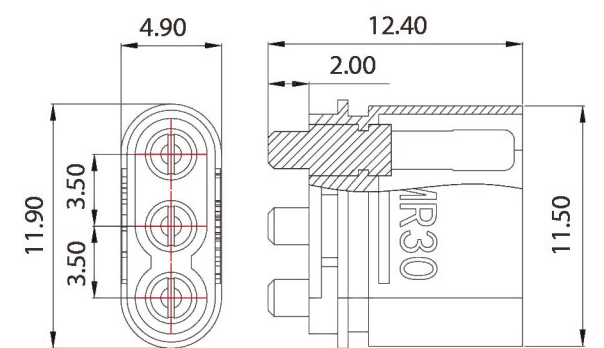
产品型号 (Item No) MR30PB-FB	产品材质及基本参数 (Material & Parameter)			
	产品型号 Item No.	MR30PB-FB	接触电阻 CR	0.75mΩ
专利号 (Patent) 201530410534.7	颜色 COLOR	3	额定电压	DC 500V
客户图纸 (Drawing)	金属材质 Metal Material	铜镀金 Brass Gold Plated	额定电流 RC	15A
	绝缘材质 Plastic Material	PA	瞬时电流 MC	30A
	阻燃等级 FR LEVEL	UL94 V0	推荐使用次数 USE TIMES	1000 TIMES
	推荐应用 Recommend USE	控制器 CONTROLLER	推荐线规 Cable SPEC.	PCB
	安规认证 CERTIFICATION	CE/UL	工作温度 TEMPERATURE	-20°C to 120°C

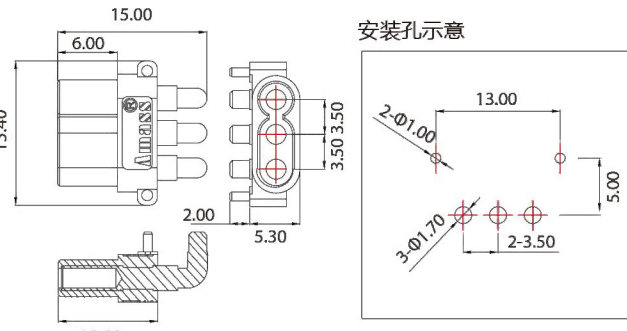

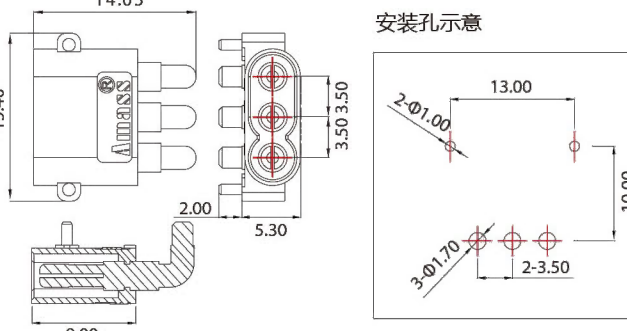
产品型号 (Item No) MR30PB-M	产品材质及基本参数 (Material & Parameter)			
	产品型号 Item No.	MR30PB-M	接触电阻 CR	0.75mΩ
专利号 (Patent) 201530410534.7	颜色 COLOR	3	额定电压	DC 500V
客户图纸 (Drawing)	金属材质 Metal Material	铜镀金 Brass Gold Plated	额定电流 RC	15A
	绝缘材质 Plastic Material	PA	瞬时电流 MC	30A
	阻燃等级 FR LEVEL	UL94 V0	推荐使用次数 USE TIMES	1000 TIMES
	推荐应用 Recommend USE	电机 MOTOR	推荐线规 Cable SPEC.	PCB
	安规认证 CERTIFICATION	CE/UL	工作温度 TEMPERATURE	-20°C to 120°C

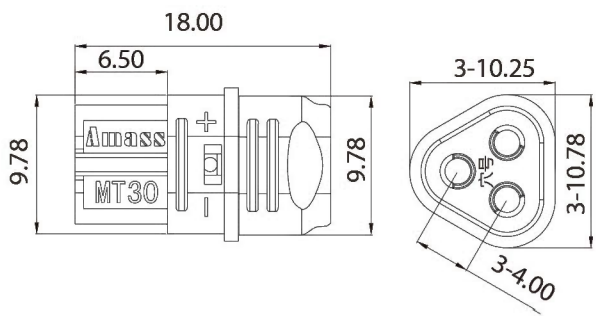

产品型号 (Item No) MR30PW-FB	产品材质及基本参数 (Material & Parameter)			
	产品型号 Item No.	MR30PW-FB	接触电阻 CR	0.80mΩ
专利号 (Patent) 201530415881.9	颜色 COLOR	3	额定电压	DC 500V
客户图纸 (Drawing)	金属材质 Metal Material	铜镀金 Brass Gold Plated	额定电流 RC	15A
	绝缘材质 Plastic Material	PA	瞬时电流 MC	30A
	阻燃等级 FR LEVEL	UL94 V0	推荐使用次数 USE TIMES	1000 TIMES
	推荐应用 Recommend USE	控制器 CONTROLLER	推荐线规 Cable SPEC.	PCB
	安规认证 CERTIFICATION	CE/UL	工作温度 TEMPERATURE	-20°C to 120°C

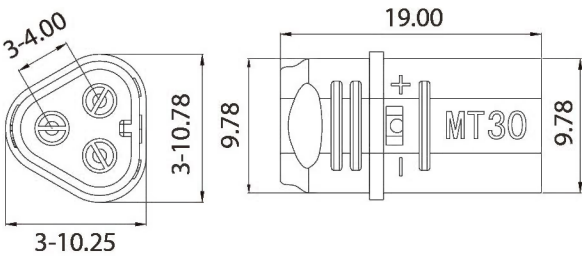
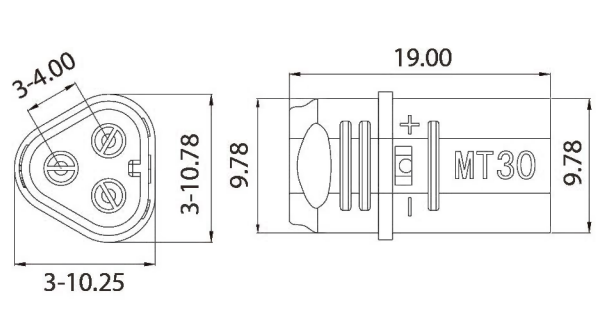
产品型号 (Item No) MR30PW-M	产品材质及基本参数 (Material & Parameter)			
	产品型号 Item No.	MR30PW-M	接触电阻 CR	0.80mΩ
专利号 (Patent) 201530415881.9	颜色 COLOR	3	额定电压	DC 500V
客户图纸 (Drawing)	金属材质 Metal Material	铜镀金 Brass Gold Plated	额定电流 RC	15A
	绝缘材质 Plastic Material	PA	瞬时电流 MC	30A
	阻燃等级 FR LEVEL	UL94 V0	推荐使用次数 USE TIMES	1000 TIMES
	推荐应用 Recommend USE	电机 MOTOR	推荐线规 Cable SPEC.	PCB
	安规认证 CERTIFICATION	CE/UL	工作温度 TEMPERATURE	-20°C to 120°C

产品型号 (Item No) MT30-F	产品材质及基本参数 (Material & Parameter)			
	产品型号 Item No.	MT30-F	接触电阻 CR	1.00mΩ
	颜色 COLOR		额定电压	DC 500V
专利号 (Patent) ---	金属材质 Metal Material	铜镀金 Brass Gold Plated	额定电流 RC	15A
客户图纸 (Drawing)	绝缘材质 Plastic Material	PA	瞬时电流 MC	30A
	阻燃等级 FR LEVEL	UL94 V0	推荐使用次数 USE TIMES	1000 TIMES
	推荐应用 Recommend USE	控制器 CONTROLLER	推荐线规 Cable SPEC.	16AWG
	安规认证 CERTIFICATION	---	工作温度 TEMPERATURE	-20°C to 120°C

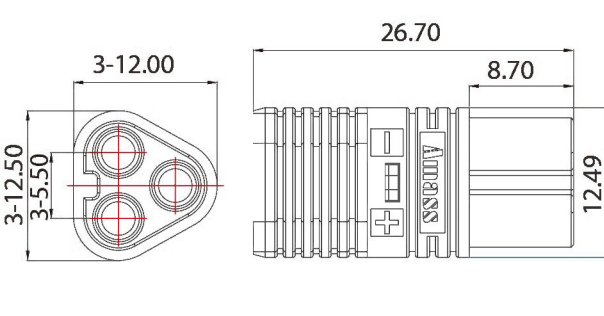
产品型号 (Item No) MT30-M	产品材质及基本参数 (Material & Parameter)			
	产品型号 Item No.	MT30-M	接触电阻 CR	1.00mΩ
	颜色 COLOR		额定电压	DC 500V
专利号 (Patent) ---	金属材质 Metal Material	铜镀金 Brass Gold Plated	额定电流 RC	15A
客户图纸 (Drawing)	绝缘材质 Plastic Material	PA	瞬时电流 MC	30A
	阻燃等级 FR LEVEL	UL94 V0	推荐使用次数 USE TIMES	1000 TIMES
	推荐应用 Recommend USE	电机 MOTOR	推荐线规 Cable SPEC.	16AWG
	安规认证 CERTIFICATION	CE/UL	工作温度 TEMPERATURE	-20°C to 120°C

产品型号 (Item No) MT60-F	产品材质及基本参数 (Material & Parameter)			
	产品型号 Item No.	MT60-F	接触电阻 CR	0.45mΩ
	颜色 COLOR		额定电压	DC 500V
专利号 (Patent) 201430028774.6	金属材质 Metal Material	铜镀金 Brass Gold Plated	额定电流 RC	30A
客户图纸 (Drawing)	绝缘材质 Plastic Material	PA	瞬时电流 MC	60A
	阻燃等级 FR LEVEL	UL94 V0	推荐使用次数 USE TIMES	1000 TIMES
	推荐应用 Recommend USE	电池 BATTERY	推荐线规 Cable SPEC.	12AWG
	安规认证 CERTIFICATION	---	工作温度 TEMPERATURE	-20°C to 120°C

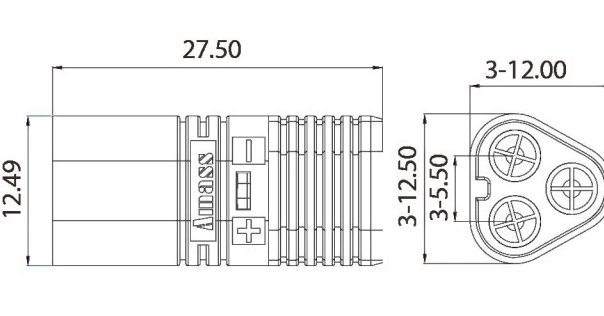
产品型号 (Item No) MT60-M	产品材质及基本参数 (Material & Parameter)			
	产品型号 Item No.	MT60-M	接触电阻 CR	0.45mΩ
	颜色 COLOR		额定电压	DC 500V
专利号 (Patent) 201430028774.6	金属材质 Metal Material	铜镀金 Brass Gold Plated	额定电流 RC	30A
客户图纸 (Drawing)	绝缘材质 Plastic Material	PA	瞬时电流 MC	60A
	阻燃等级 FR LEVEL	UL94 V0	推荐使用次数 USE TIMES	1000 TIMES
	推荐应用 Recommend USE	控制器 CONTROLLER	推荐线规 Cable SPEC.	12AWG
	安规认证 CERTIFICATION	---	工作温度 TEMPERATURE	-20°C to 120°C

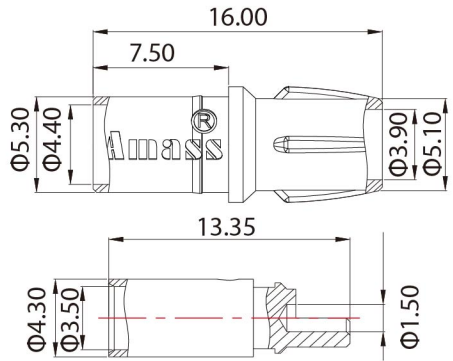
产品型号 (Item No) SH3.5-F 	产品材质及基本参数 (Material & Parameter)			
专利号 (Patent) 201530410156.2 客户图纸 (Drawing) 	产品型号 Item No.	SH3.5-F	接触电阻 CR	0.48mΩ
	颜色 COLOR	2	额定电压	DC 500V
	金属材质 Metal Material	铜镀金 Brass Gold Plated	额定电流 RC	20A
	绝缘材质 Plastic Material	PA	瞬时电流 MC	40A
	阻燃等级 FR LEVEL	UL94 V0	推荐使用次数 USE TIMES	1000 TIMES
	推荐应用 Recommend USE	控制器 CONTROLLER	推荐线规 Cable SPEC.	16AWG
	安规认证 CERTIFICATION	CE/UL	工作温度 TEMPERATURE	-20°C to 120°C

产品型号 (Item No) SH3.5-M 	产品材质及基本参数 (Material & Parameter)			
专利号 (Patent) 201530410156.2 客户图纸 (Drawing) 	产品型号 Item No.	SH3.5-M	接触电阻 CR	0.48mΩ
	颜色 COLOR	2	额定电压	DC 500V
	金属材质 Metal Material	铜镀金 Brass Gold Plated	额定电流 RC	20A
	绝缘材质 Plastic Material	PA	瞬时电流 MC	40A
	阻燃等级 FR LEVEL	UL94 V0	推荐使用次数 USE TIMES	1000 TIMES
	推荐应用 Recommend USE	电机 MOTOR	推荐线规 Cable SPEC.	16AWG
	安规认证 CERTIFICATION	CE/UL	工作温度 TEMPERATURE	-20°C to 120°C

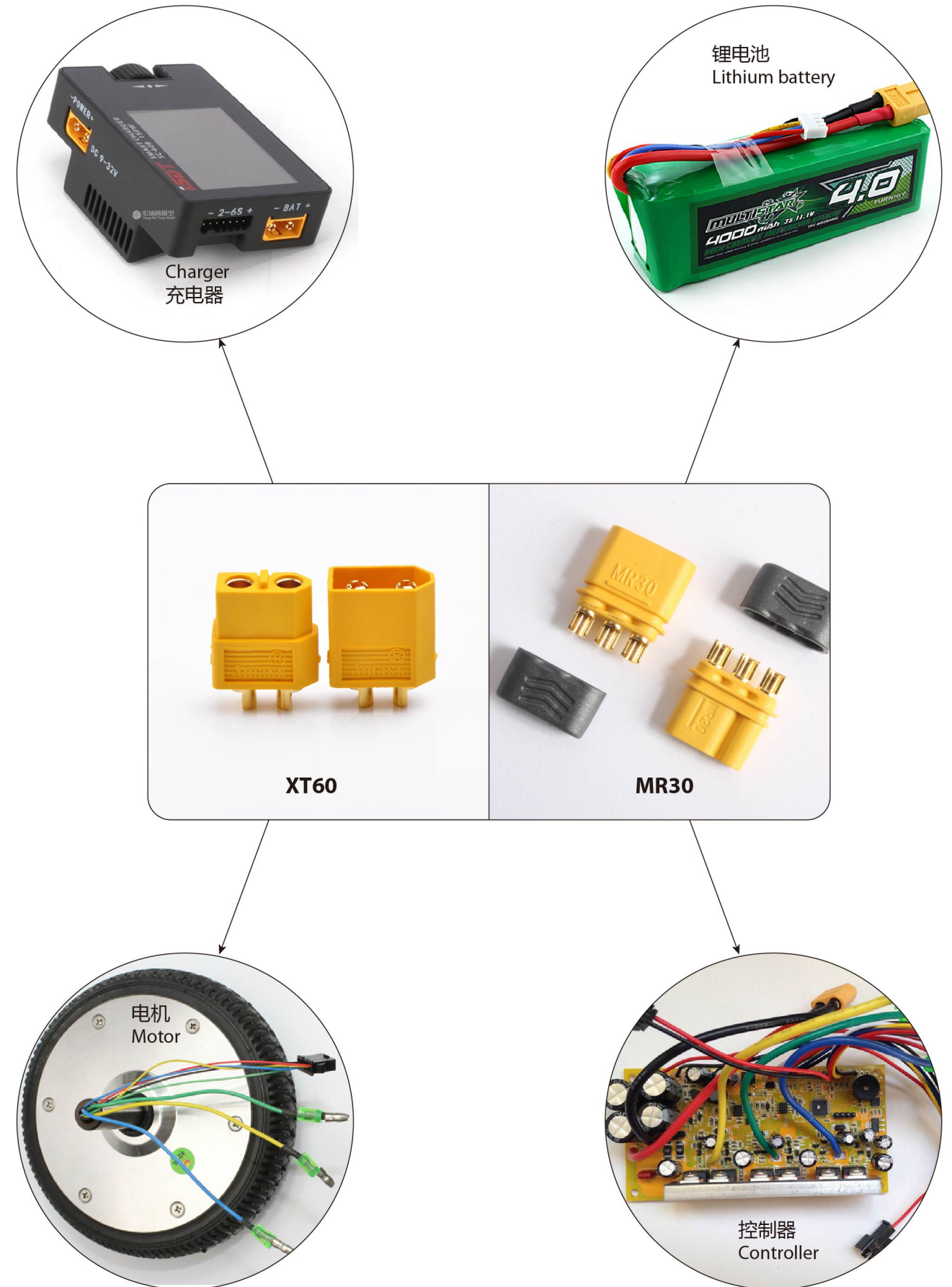

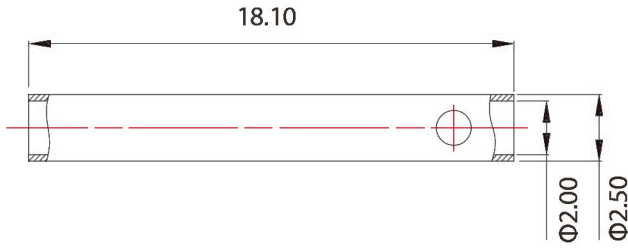
产品型号 (Item No) GC2010-F	产品材质及基本参数 (Material & Parameter)			
	产品型号 Item No.	GC2010-F	接触电阻 CR	1.50mΩ
	金属材质 Metal Material	铜镀金 Brass Gold Plated	额定电流 RC	15A
	推荐线规 Cable SPEC.	18AWG	瞬时电流 MC	30A
	推荐使用次数 USE TIMES	2000 TIMES		
客户图纸 (Drawing)				
				

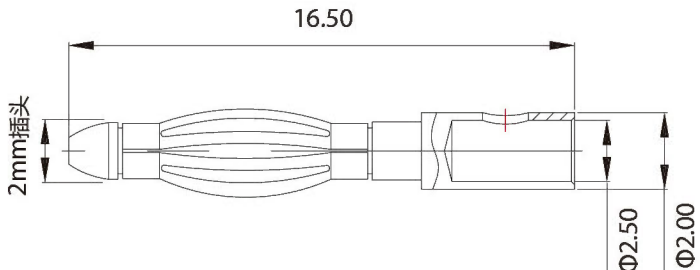
产品型号 (Item No) GC2010-M	产品材质及基本参数 (Material & Parameter)			
	产品型号 Item No.	GC2010-M	接触电阻 CR	1.50mΩ
	金属材质 Metal Material	铜镀金 Brass Gold Plated	额定电流 RC	15A
	推荐线规 Cable SPEC.	18AWG	瞬时电流 MC	30A
	推荐使用次数 USE TIMES	2000 TIMES		
客户图纸 (Drawing)				
				

产品型号 (Item No) GC2011-F	产品材质及基本参数 (Material & Parameter)			
	产品型号 Item No.	GC2011-F	接触电阻 CR	0.80mΩ
	金属材质 Metal Material	铜镀金 Brass Gold Plated	额定电流 RC	15A
	推荐线规 Cable SPEC.	18AWG	瞬时电流 MC	30A
	推荐使用次数 USE TIMES	2000 TIMES		
客户图纸 (Drawing)				
				

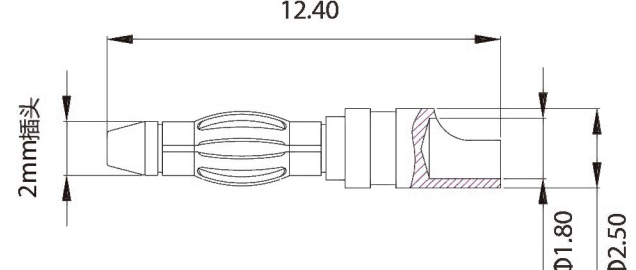
产品型号 (Item No) GC2011-M	产品材质及基本参数 (Material & Parameter)			
	产品型号 Item No.	GC2011-M	接触电阻 CR	0.80mΩ
	金属材质 Metal Material	铜镀金 Brass Gold Plated	额定电流 RC	15A
	推荐线规 Cable SPEC.	18AWG	瞬时电流 MC	30A
	推荐使用次数 USE TIMES	2000 TIMES		
客户图纸 (Drawing)				
				

产品型号 (Item No) GC2014-F	产品材质及基本参数 (Material & Parameter)			
	产品型号 Item No.	GC2014-F	接触电阻 CR	1.20mΩ
	金属材质 Metal Material	铜镀金 Brass Gold Plated	额定电流 RC	15A
	推荐线规 Cable SPEC.	16AWG	瞬时电流 MC	30A
	推荐使用次数 USE TIMES	2000 TIMES		

客户图纸 (Drawing)

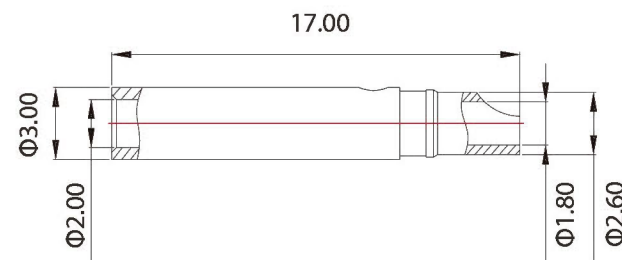

产品型号 (Item No) GC2014-M	产品材质及基本参数 (Material & Parameter)			
	产品型号 Item No.	GC2014-M	接触电阻 CR	1.20mΩ
	金属材质 Metal Material	铜镀金 Brass Gold Plated	额定电流 RC	15A
	推荐线规 Cable SPEC.	16AWG	瞬时电流 MC	30A
	推荐使用次数 USE TIMES	2000 TIMES		

客户图纸 (Drawing)

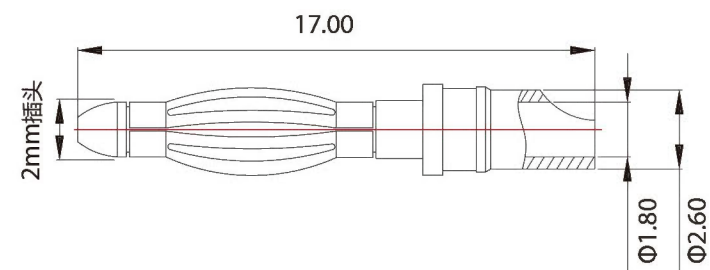

产品型号 (Item No) GC3010-F	产品材质及基本参数 (Material & Parameter)			
	产品型号 Item No.	GC3010-F	接触电阻 CR	0.80mΩ
	金属材质 Metal Material	铜镀金 Brass Gold Plated	额定电流 RC	20A
	推荐线规 Cable SPEC.	16AWG	瞬时电流 MC	40A
	推荐使用次数 USE TIMES	2000 TIMES		

客户图纸 (Drawing)

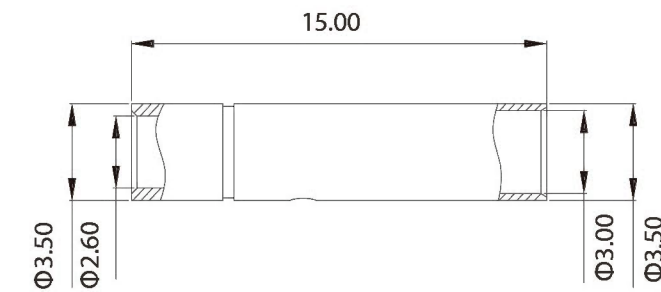

产品型号 (Item No) GC3010-M	产品材质及基本参数 (Material & Parameter)			
	产品型号 Item No.	GC3010-F	接触电阻 CR	0.80mΩ
	金属材质 Metal Material	铜镀金 Brass Gold Plated	额定电流 RC	20A
	推荐线规 Cable SPEC.	16AWG	瞬时电流 MC	40A
	推荐使用次数 USE TIMES	2000 TIMES		

客户图纸 (Drawing)

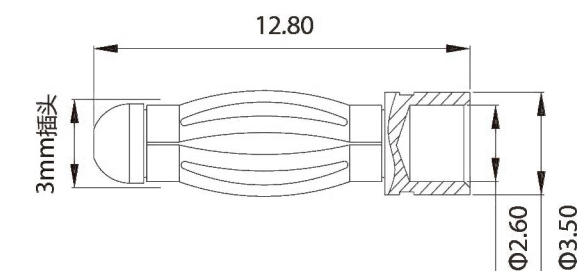

产品型号 (Item No) GC3510-F	产品材质及基本参数 (Material & Parameter)			
	产品型号 Item No.	GC3510-F	接触电阻 CR	0.45mΩ
	金属材质 Metal Material	铜镀金 Brass Gold Plated	额定电流 RC	25A
	推荐线规 Cable SPEC.	14AWG	瞬时电流 MC	50A
	推荐使用次数 USE TIMES	2000 TIMES		

客户图纸 (Drawing)

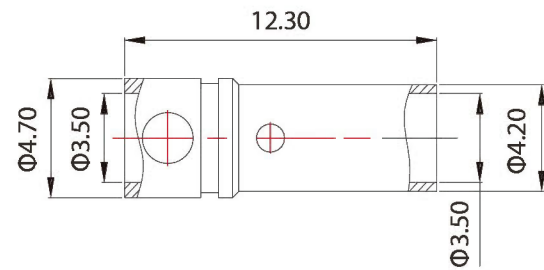

产品型号 (Item No) GC3510-M	产品材质及基本参数 (Material & Parameter)			
	产品型号 Item No.	GC3510-M	接触电阻 CR	0.45mΩ
	金属材质 Metal Material	铜镀金 Brass Gold Plated	额定电流 RC	25A
	推荐线规 Cable SPEC.	14AWG	瞬时电流 MC	50A
	推荐使用次数 USE TIMES	2000 TIMES		

客户图纸 (Drawing)

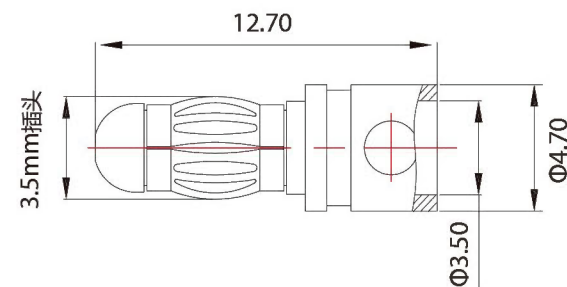

产品型号 (Item No) GC3511-F	产品材质及基本参数 (Material & Parameter)			
	产品型号 Item No.	GC3511-F	接触电阻 CR	0.45mΩ
	金属材质 Metal Material	铜镀金 Brass Gold Plated	额定电流 RC	25A
	推荐线规 Cable SPEC.	14AWG	瞬时电流 MC	50A
	推荐使用次数 USE TIMES	2000 TIMES		

客户图纸 (Drawing)

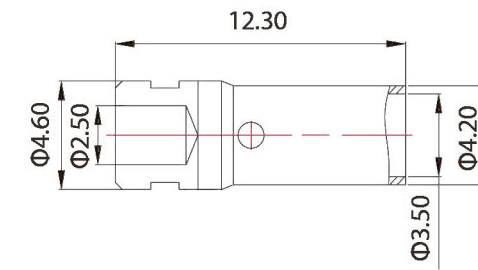

产品型号 (Item No) GC3511-M	产品材质及基本参数 (Material & Parameter)			
	产品型号 Item No.	GC3511-M	接触电阻 CR	0.45mΩ
	金属材质 Metal Material	铜镀金 Brass Gold Plated	额定电流 RC	25A
	推荐线规 Cable SPEC.	14AWG	瞬时电流 MC	50A
	推荐使用次数 USE TIMES	2000 TIMES		

客户图纸 (Drawing)

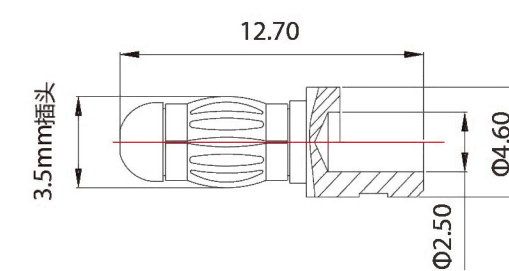

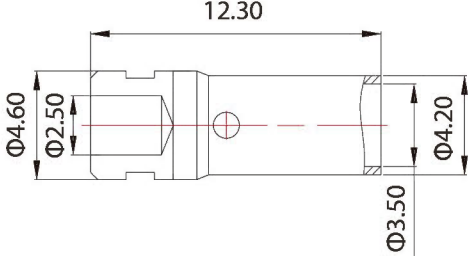
产品型号 (Item No) GC3514-F=GC3511-F	产品材质及基本参数 (Material & Parameter)			
	产品型号 Item No.	GC3514-F	接触电阻 CR	0.45mΩ
	金属材质 Metal Material	铜镀金 Brass Gold Plated	额定电流 RC	25A
	推荐线规 Cable SPEC.	14AWG	瞬时电流 MC	50A
	推荐使用次数 USE TIMES	2000 TIMES		
客户图纸 (Drawing)				
				

产品型号 (Item No) GC3514-M	产品材质及基本参数 (Material & Parameter)			
	产品型号 Item No.	GC3514-M	接触电阻 CR	1.50mΩ
	金属材质 Metal Material	铜镀金 Brass Gold Plated	额定电流 RC	30A
	推荐线规 Cable SPEC.	14AWG	瞬时电流 MC	60A
	推荐使用次数 USE TIMES	1000 TIMES		
客户图纸 (Drawing)				
				

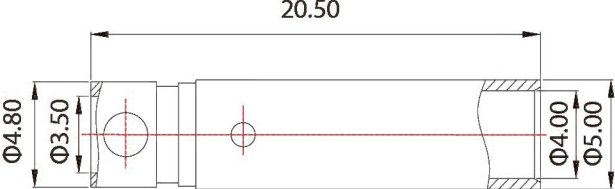
产品型号 (Item No) GC4010-F	产品材质及基本参数 (Material & Parameter)			
	产品型号 Item No.	GC4010-F	接触电阻 CR	0.55mΩ
	金属材质 Metal Material	铜镀金 Brass Gold Plated	额定电流 RC	32A
	推荐线规 Cable SPEC.	12AWG	瞬时电流 MC	70A
	推荐使用次数 USE TIMES	2000 TIMES		
客户图纸 (Drawing)				
				

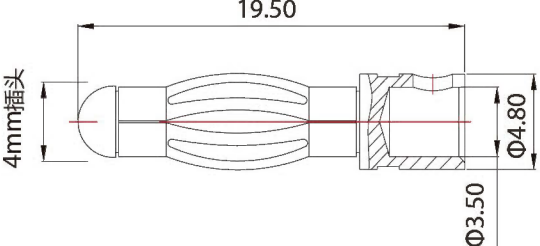
产品型号 (Item No) GC4010-M	产品材质及基本参数 (Material & Parameter)			
	产品型号 Item No.	GC4010-M	接触电阻 CR	0.55mΩ
	金属材质 Metal Material	铜镀金 Brass Gold Plated	额定电流 RC	32A
	推荐线规 Cable SPEC.	12AWG	瞬时电流 MC	70A
	推荐使用次数 USE TIMES	2000 TIMES		
客户图纸 (Drawing)				
				

产品型号 (Item No) GC4011-F	产品材质及基本参数 (Material & Parameter)			
	产品型号 Item No.	GC4011-F	接触电阻 CR	0.65mΩ
	金属材质 Metal Material	铜镀金 Brass Gold Plated	额定电流 RC	32A
	推荐线规 Cable SPEC.	12AWG	瞬时电流 MC	70A
	推荐使用次数 USE TIMES	2000 TIMES		

客户图纸 (Drawing)

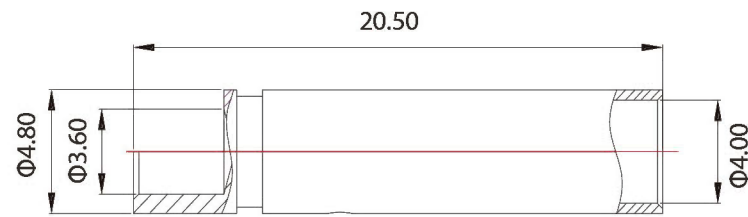

产品型号 (Item No) GC4011-M	产品材质及基本参数 (Material & Parameter)			
	产品型号 Item No.	GC4011-M	接触电阻 CR	0.65mΩ
	金属材质 Metal Material	铜镀金 Brass Gold Plated	额定电流 RC	32A
	推荐线规 Cable SPEC.	12AWG	瞬时电流 MC	70A
	推荐使用次数 USE TIMES	2000 TIMES		

客户图纸 (Drawing)

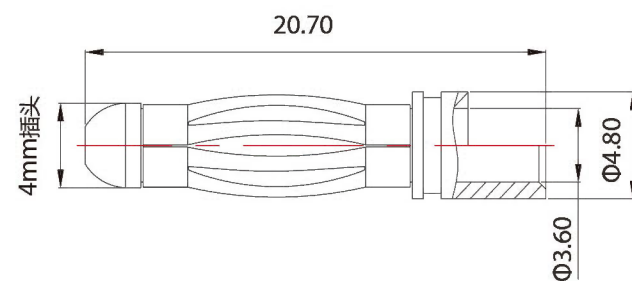

产品型号 (Item No) GC4012-F	产品材质及基本参数 (Material & Parameter)			
	产品型号 Item No.	GC4012-F	接触电阻 CR	0.80mΩ
	金属材质 Metal Material	铜镀金 Brass Gold Plated	额定电流 RC	32A
	推荐线规 Cable SPEC.	12AWG	瞬时电流 MC	70A
	推荐使用次数 USE TIMES	2000 TIMES		

客户图纸 (Drawing)

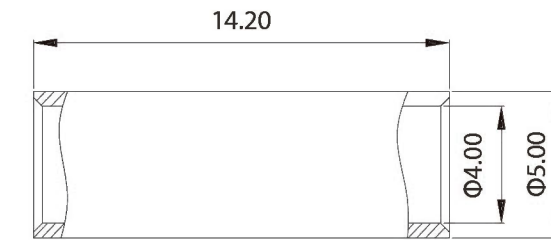

产品型号 (Item No) GC4012-M	产品材质及基本参数 (Material & Parameter)			
	产品型号 Item No.	GC4012-M	接触电阻 CR	0.80mΩ
	金属材质 Metal Material	铜镀金 Brass Gold Plated	额定电流 RC	32A
	推荐线规 Cable SPEC.	12AWG	瞬时电流 MC	70A
	推荐使用次数 USE TIMES	2000 TIMES		

客户图纸 (Drawing)

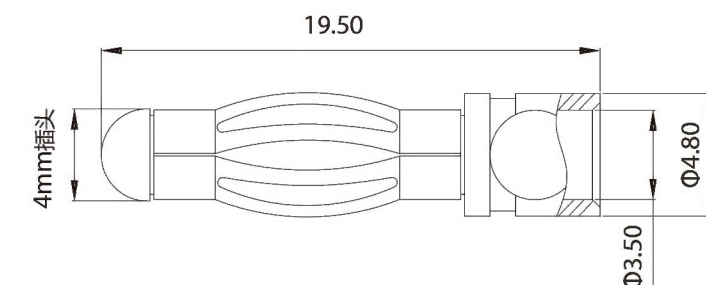

产品型号 (Item No) GC4013-F	产品材质及基本参数 (Material & Parameter)			
	产品型号 Item No.	GC4013-F	接触电阻 CR	0.30mΩ
	金属材质 Metal Material	铜镀金 Brass Gold Plated	额定电流 RC	36A
	推荐线规 Cable SPEC.	12AWG	瞬时电流 MC	70A
	推荐使用次数 USE TIMES	1000 TIMES		

客户图纸 (Drawing)

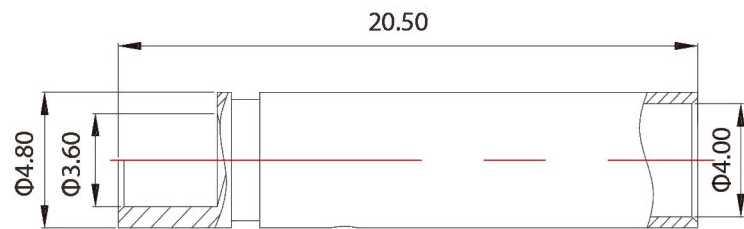

产品型号 (Item No) GC4013-M	产品材质及基本参数 (Material & Parameter)			
	产品型号 Item No.	GC4013-M	接触电阻 CR	0.30mΩ
	金属材质 Metal Material	铜镀金 Brass Gold Plated	额定电流 RC	36A
	推荐线规 Cable SPEC.	12AWG	瞬时电流 MC	70A
	推荐使用次数 USE TIMES	1000 TIMES		

客户图纸 (Drawing)

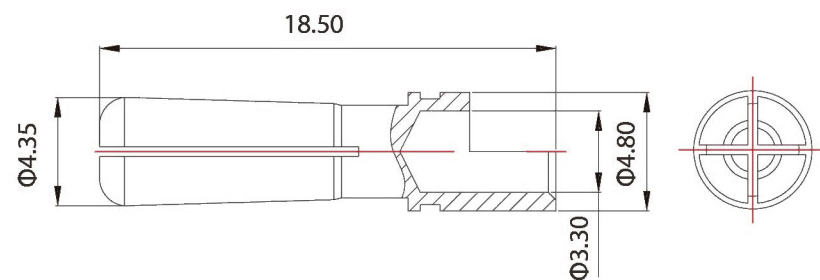

产品型号 (Item No) GC4016-F	产品材质及基本参数 (Material & Parameter)			
	产品型号 Item No.	GC4016-F	接触电阻 CR	0.45mΩ
	金属材质 Metal Material	铜镀金 Brass Gold Plated	额定电流 RC	32A
	推荐线规 Cable SPEC.	12AWG	瞬时电流 MC	40A
	推荐使用次数 USE TIMES	2000 TIMES		

客户图纸 (Drawing)

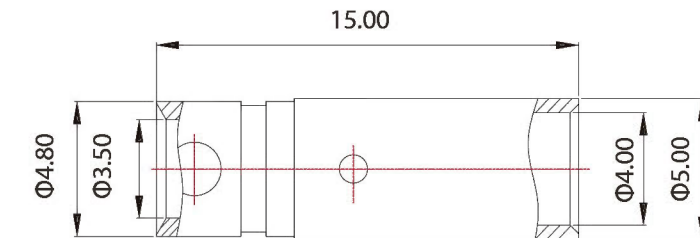

产品型号 (Item No) GC4016-M	产品材质及基本参数 (Material & Parameter)			
	产品型号 Item No.	GC4016-M	接触电阻 CR	0.45mΩ
	金属材质 Metal Material	铜镀金 Brass Gold Plated	额定电流 RC	32A
	推荐线规 Cable SPEC.	12AWG	瞬时电流 MC	70A
	推荐使用次数 USE TIMES	2000 TIMES		

客户图纸 (Drawing)

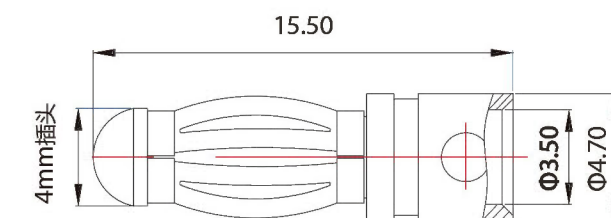

产品型号 (Item No) GC5510-F	产品材质及基本参数 (Material & Parameter)			
	产品型号 Item No.	GC5510-F	接触电阻 CR	0.25mΩ
	金属材质 Metal Material	铜镀金 Brass Gold Plated	额定电流 RC	50A
	推荐线规 Cable SPEC.	8AWG	瞬时电流 MC	110A
	推荐使用次数 USE TIMES	1000 TIMES		

客户图纸 (Drawing)

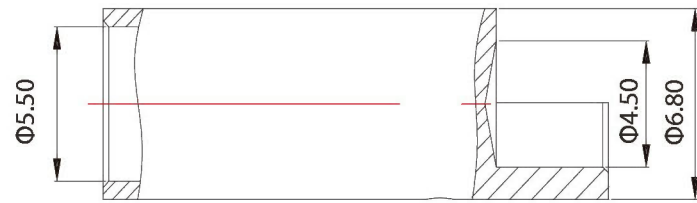

产品型号 (Item No) GC5510-M	产品材质及基本参数 (Material & Parameter)			
	产品型号 Item No.	GC5510-M	接触电阻 CR	0.25mΩ
	金属材质 Metal Material	铜镀金 Brass Gold Plated	额定电流 RC	50A
	推荐线规 Cable SPEC.	8AWG	瞬时电流 MC	110A
	推荐使用次数 USE TIMES	1000 TIMES		

客户图纸 (Drawing)

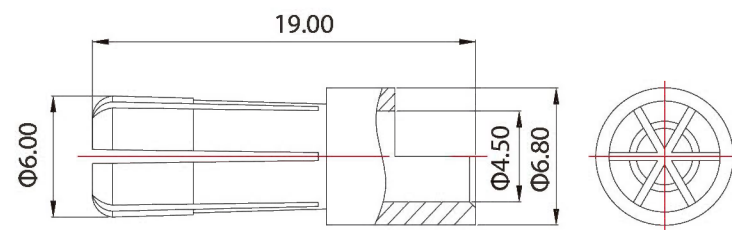

产品型号 (Item No) GC6010-F	产品材质及基本参数 (Material & Parameter)			
	产品型号 Item No.	GC6010-F	接触电阻 CR	0.20mΩ
	金属材质 Metal Material	铜镀金 Brass Gold Plated	额定电流 RC	60A
	推荐线规 Cable SPEC.	8AWG	瞬时电流 MC	130A
	推荐使用次数 USE TIMES	1000 TIMES		

客户图纸 (Drawing)

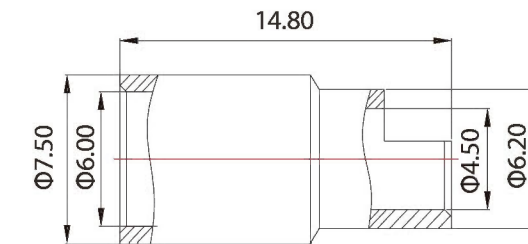

产品型号 (Item No) GC6010-M	产品材质及基本参数 (Material & Parameter)			
	产品型号 Item No.	GC6010-M	接触电阻 CR	0.20mΩ
	金属材质 Metal Material	铜镀金 Brass Gold Plated	额定电流 RC	60A
	推荐线规 Cable SPEC.	8AWG	瞬时电流 MC	130A
	推荐使用次数 USE TIMES	1000 TIMES		

客户图纸 (Drawing)

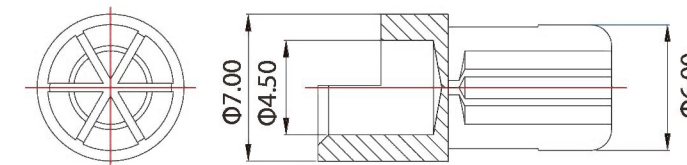

产品型号 (Item No) GC6510-F	产品材质及基本参数 (Material & Parameter)			
	产品型号 Item No.	GC6510-F	接触电阻 CR	1.50mΩ
	金属材质 Metal Material	铜镀金 Brass Gold Plated	额定电流 RC	65A
	推荐线规 Cable SPEC.	8AWG	瞬时电流 MC	140A
	推荐使用次数 USE TIMES	1000 TIMES		

客户图纸 (Drawing)

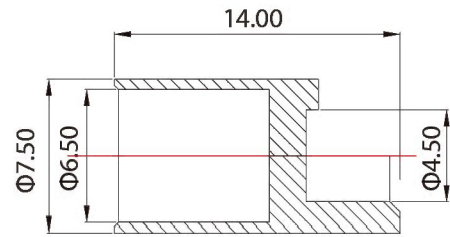

产品型号 (Item No) GC6510-M	产品材质及基本参数 (Material & Parameter)			
	产品型号 Item No.	GC6510-M	接触电阻 CR	1.50mΩ
	金属材质 Metal Material	铜镀金 Brass Gold Plated	额定电流 RC	65A
	推荐线规 Cable SPEC.	8AWG	瞬时电流 MC	140A
	推荐使用次数 USE TIMES	1000 TIMES		

客户图纸 (Drawing)

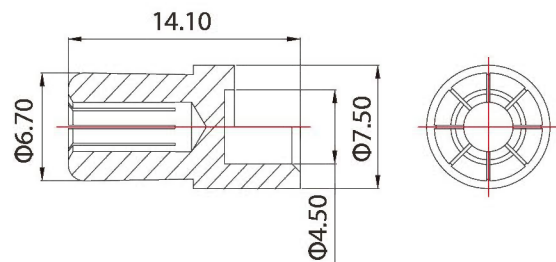

产品型号 (Item No) GC8010-F	产品材质及基本参数 (Material & Parameter)			
	产品型号 Item No.	GC8010-F	接触电阻 CR	0.15mΩ
	金属材质 Metal Material	铜镀金 Brass Gold Plated	额定电流 RC	80A
	推荐线规 Cable SPEC.	6AWG	瞬时电流 MC	170A
	推荐使用次数 USE TIMES	1000 TIMES		

客户图纸 (Drawing)

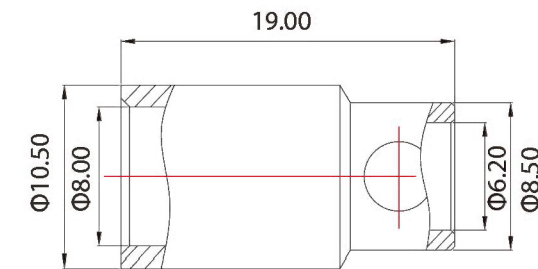

产品型号 (Item No) GC8010-M	产品材质及基本参数 (Material & Parameter)			
	产品型号 Item No.	GC8010-M	接触电阻 CR	0.15mΩ
	金属材质 Metal Material	铜镀金 Brass Gold Plated	额定电流 RC	80A
	推荐线规 Cable SPEC.	6AWG	瞬时电流 MC	170A
	推荐使用次数 USE TIMES	1000 TIMES		

客户图纸 (Drawing)

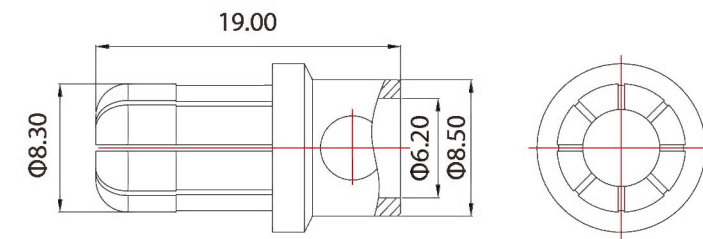

OTHERS SERIERS

其他

我们提供机器人焊线服务并有UL焊线资质。承接各类线规焊接加工服务，日均产能12万条。

We provide the Robot Soldering service and have the UL soldering certification. Any kinds of cable specification is available and 120,000pcs capacity every day.



UL焊线资质

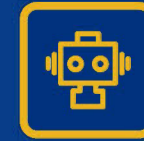

机器人服务



12万日均产量

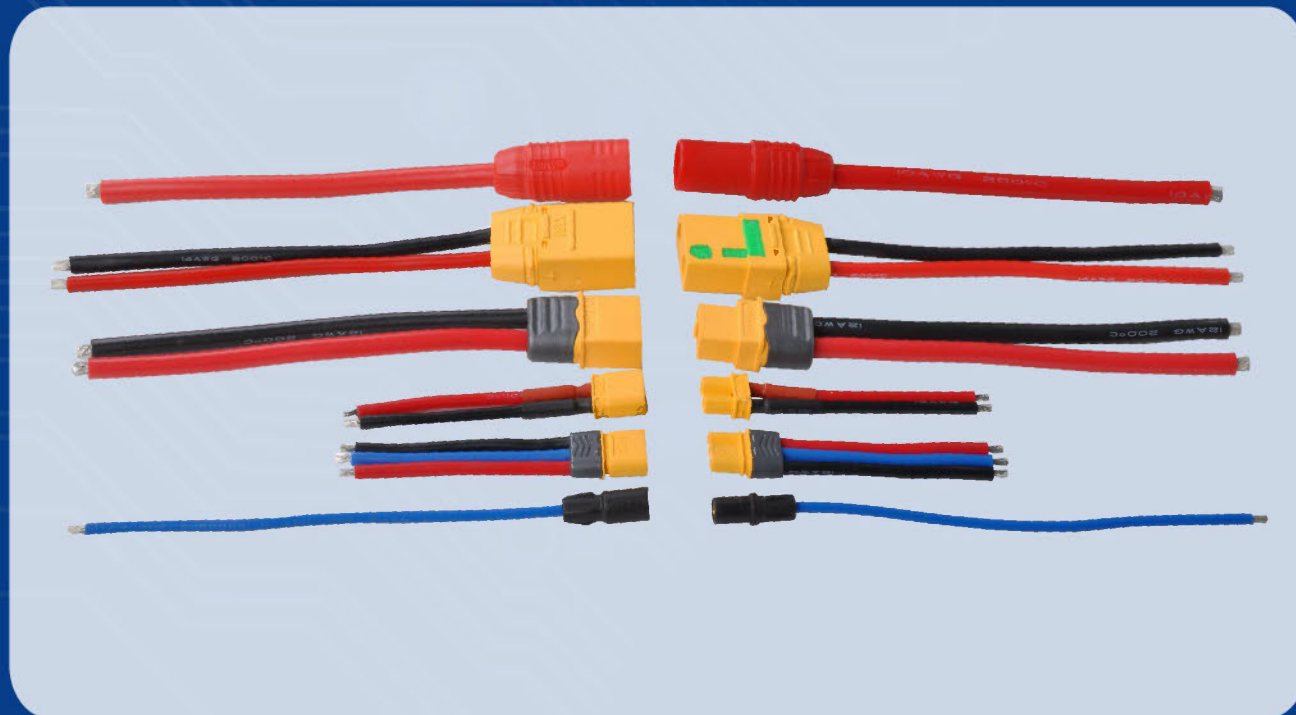

常州市艾迈斯电子有限公司

CHANGZHOU AMASS ELECTRONICS CO.,LTD.

地址:江苏省常州市武进礼嘉镇工业区

Add:Qingyang Rd. Lijia Town, Wujin Dis,

Changzhou City,Jiangsu

Tel: 86-519-86731695 Fax: 86-519-86735861

E-mail: hzy@china-amass.com

Web: www.china-amass.com