

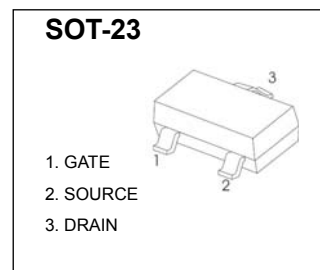

## SOT-23 Plastic-Encapsulate Transistors

### CJ3420 N-Channel Enhancement Mode Field Effect Transistor

$V_{(BR)DSS}$	$R_{DS(on)MAX}$	$I_D$
20V	24mΩ@ 10V	6A
	27mΩ@4.5V	
	42mΩ@2.5V	
	74mΩ@1.8V	



#### DESCRIPTION

The CJ3420 uses advanced trench technology to provide excellent  $R_{DS(on)}$ . This device is suitable for use as a uni-directional or bi-directional load switch.

#### MARKING

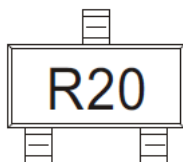

#### Equivalent Circuit

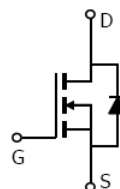

#### Maximum ratings ( $T_a=25^\circ\text{C}$ unless otherwise noted)

Parameter	Symbol	Value	Unit
Drain-Source Voltage	$V_{DS}$	20	V
Gate-Source Voltage	$V_{GS}$	±12	
Continuous Drain Current	$I_D$	6	A
Pulsed Drain Current	$I_{DM}$	25	
Maximum Body-Diode Continuous Current	$I_S$	2	
Power Dissipation	$P_D$	0.35	W
Thermal Resistance from Junction to Ambient	$R_{\theta JA}$	357	$^\circ\text{C}/\text{W}$
Junction Temperature	$T_J$	150	$^\circ\text{C}$
Storage Temperature	$T_{stg}$	-55 ~+150	

## MOSFET ELECTRICAL CHARACTERISTICS

$T_a=25^\circ\text{C}$  unless otherwise specified

Parameter	Symbol	Test Condition	Min	Typ	Max	Unit
<b>STATIC PARAMETERS</b>						
Drain-source breakdown voltage	$V_{(BR)DSS}$	$V_{GS} = 0V, I_D = 250\mu A$	20			V
Gate-source leakage current	$I_{GSS}$	$V_{DS} = 0V, V_{GS} = \pm 12V$			$\pm 100$	nA
Zero gate voltage drain current	$I_{DSS}$	$V_{DS} = 16V, V_{GS} = 0V$			1.0	$\mu A$
Gate threshold voltage	$V_{GS(th)}$	$V_{DS} = V_{GS}, I_D = 250\mu A$	0.5	0.7	1.0	V
Drain-source on-state resistance	$R_{DS(on)}$	$V_{GS} = 10V, I_D = 6.0A$		19	24	m $\Omega$
		$V_{GS} = 4.5V, I_D = 5.0A$		22	27	
		$V_{GS} = 2.5V, I_D = 4.0A$		35	42	
		$V_{GS} = 1.8V, I_D = 2.0A$			74	
Diode forward voltage	$V_{SD}$	$V_{GS} = 0V, I_S = 1A$		0.75	1	V
Forward transconductance	$g_{fs}$	$V_{DS} = 5V, I_D = 3.8A$	4			S
<b>DYNAMIC PARAMETERS*</b>						
Input capacitance	$C_{iss}$	$V_{DS} = 10V, V_{GS} = 0V, f = 1MHz$		630		pF
Output capacitance	$C_{oss}$			164		
Reverse transfer capacitance	$C_{rss}$			137		
Gate resistance	$R_g$	$V_{DS} = 0V, V_{GS} = 0V, f = 1MHz$		1.5		$\Omega$
<b>SWITCHING PARAMETERS*</b>						
Turn-on delay time	$t_{d(on)}$	$V_{GS} = 5V, V_{DS} = 10V,$ $R_L = 1.7\Omega, R_{GEN} = 6\Omega$		5.5		ns
Rise time	$t_r$			14		
Turn-off delay time	$t_{d(off)}$			29		
Fall time	$t_f$			10.2		

\*These parameters have no way to verify.

# Typical Characteristics

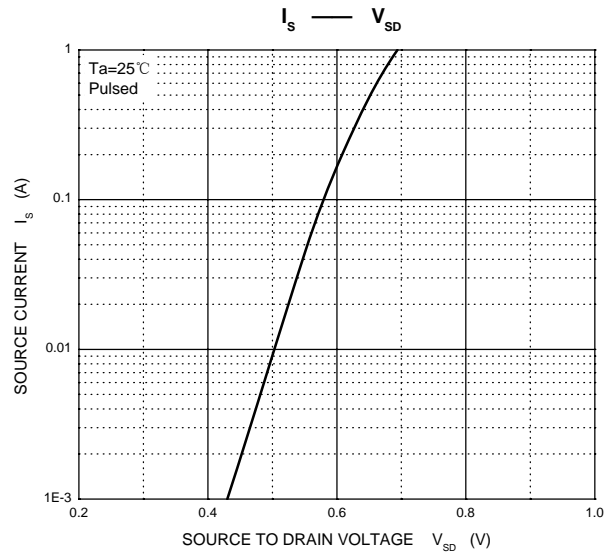
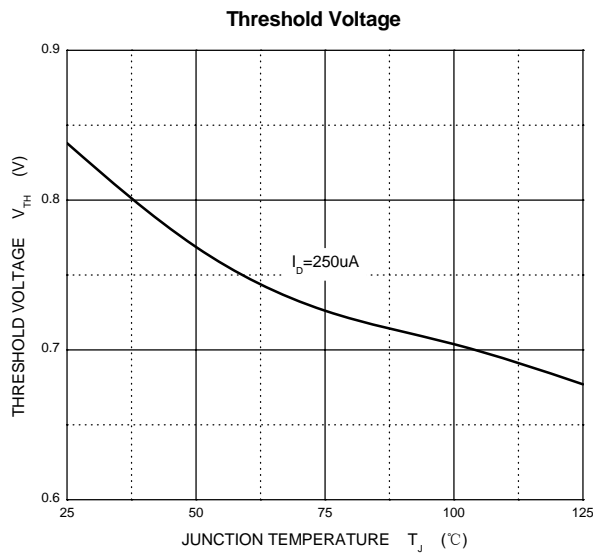
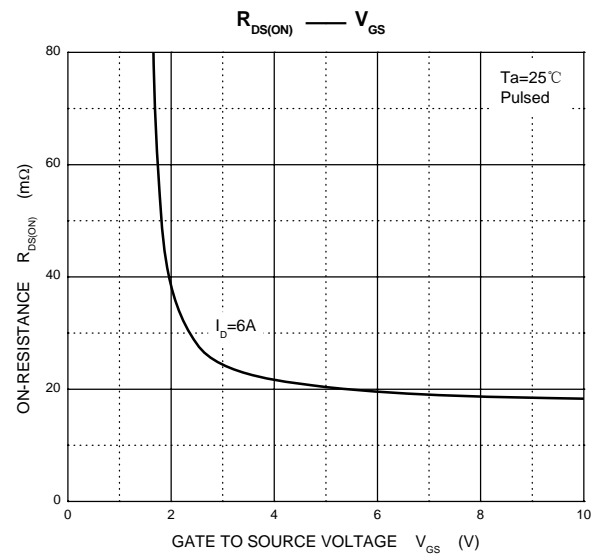
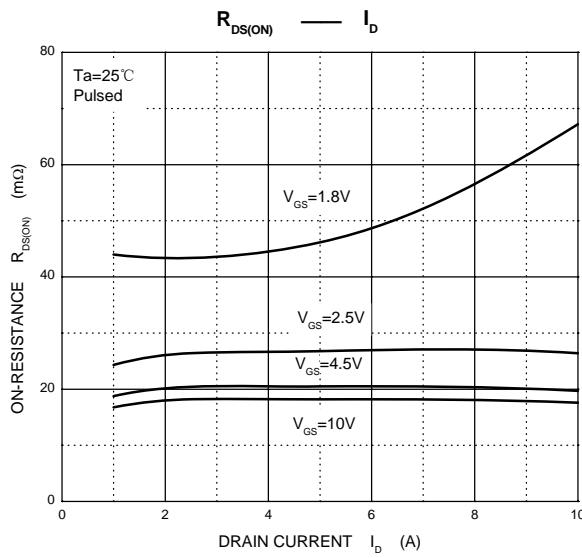
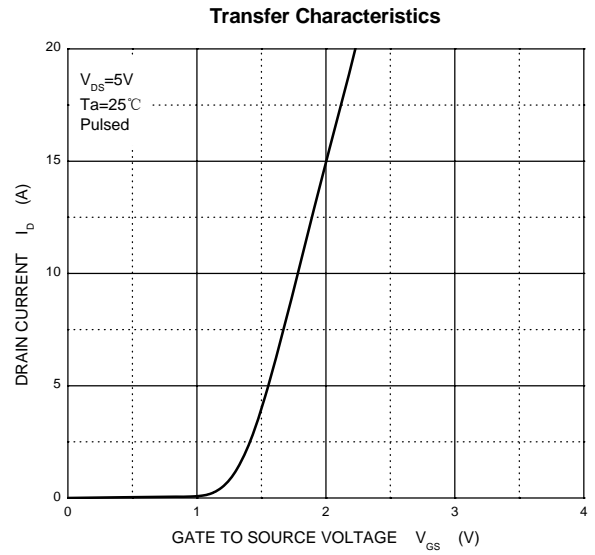
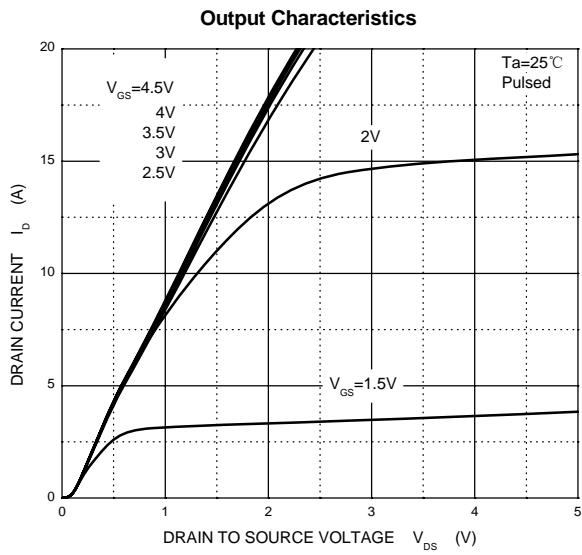

## SOT-23 Package Outline Dimensions



Symbol	Dimensions In Millimeters		Dimensions In Inches	
	Min	Max	Min	Max
A	0.900	1.150	0.035	0.045
A1	0.000	0.100	0.000	0.004
A2	0.900	1.050	0.035	0.041
b	0.300	0.500	0.012	0.020
c	0.080	0.150	0.003	0.006
D	2.800	3.000	0.110	0.118
E	1.200	1.400	0.047	0.055
E1	2.250	2.550	0.089	0.100
e	0.950 TYP		0.037 TYP	
e1	1.800	2.000	0.071	0.079
L	0.550 REF		0.022 REF	
L1	0.300	0.500	0.012	0.020
$\theta$	0°	8°	0°	8°

## SOT-23 Suggested Pad Layout



- Note:
1. Controlling dimension: in millimeters.
  2. General tolerance:  $\pm 0.05$  mm.
  3. The pad layout is for reference purposes only.

### NOTICE

JCET reserve the right to make modifications, enhancements, improvements, corrections or other changes without further notice to any product herein. JCET does not assume any liability arising out of the application or use of any product described herein.

## SOT-23 Tape and reel

### SOT-23 Embossed Carrier Tape

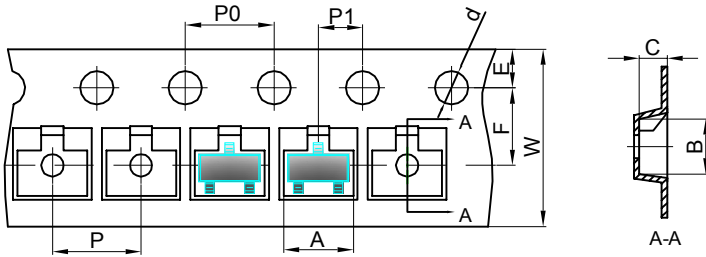

**Packaging Description:**

SOT-23 parts are shipped in tape. The carrier tape is made from a dissipative (carbon filled) polycarbonate resin. The cover tape is a multilayer film (Heat Activated Adhesive in nature) primarily composed of polyester film, adhesive layer, sealant, and anti-static sprayed agent. These reeled parts in standard option are shipped with 3,000 units per 7" or 17.8cm diameter reel. The reels are clear in color and is made of polystyrene plastic (anti-static coated).

Dimensions are in millimeter										
Pkg type	A	B	C	d	E	F	P0	P	P1	W
SOT-23	3.15	2.77	1.22	Ø1.50	1.75	3.50	4.00	4.00	2.00	8.00

### SOT-23 Tape Leader and Trailer

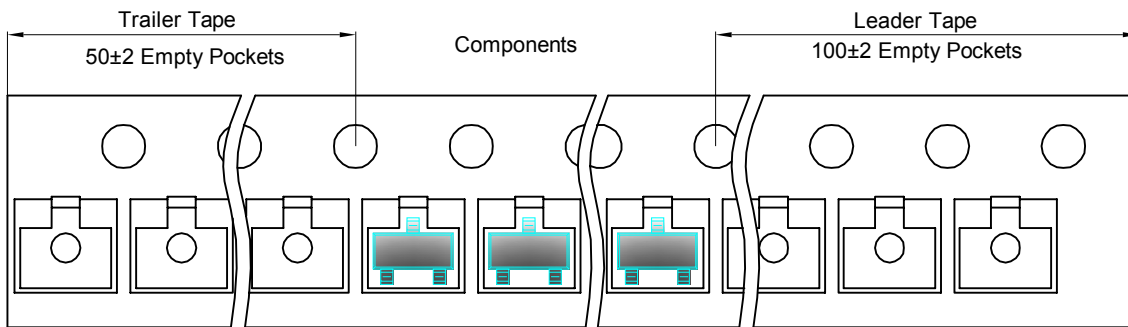

### SOT-23 Reel

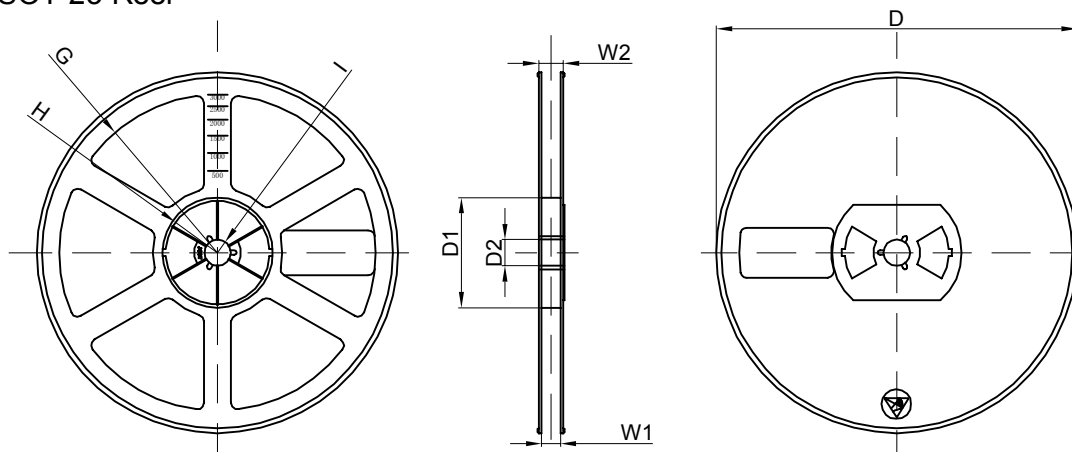

Dimensions are in millimeter								
Reel Option	D	D1	D2	G	H	I	W1	W2
7" Dia	Ø178.00	54.40	13.00	R78.00	R25.60	R6.50	9.50	12.30

REEL	Reel Size	Box	Box Size(mm)	Carton	Carton Size(mm)	G.W.(kg)
3000 pcs	7 inch	30,000 pcs	203×203×195	120,000 pcs	438×438×220	