



# SPECIFICATION

## Surface Acoustic Wave Filter

USER



USER PART No.

SEMCO PART No. **SFWG00DB002**

DOC. No. SMS-51-L-SFT FW-43

DATE July, 30, 2013

REVISION 000

WISOL					
ISSUED BY	Kim, Young-Hun 	APPROVED BY (R&D)	Hong, Seong-Su 	APPROVED BY (QC)	Jeon. Hyeon Cheol 
User					
ISSUED BY		CHECKED BY		APPROVED BY	

WISOL CO., LTD.  
373-7, GAJANG-DONG, OSAN-SI,  
GYUNGGI-DO, KOREA, 447-210  
<http://www.wisol.co.kr>

▶ **A TABLE OF CONTENTS**

<b>1. REVISION HISTORY</b> .....	3
<b>2. DEFINITION</b> .....	4
<b>3. PRECAUTIONS</b> .....	4
<b>4. OUTLINE DRAWING &amp; DIMENSIONS</b> .....	5
<b>5. MARKING</b> .....	6
<b>6. PERFORMANCE</b> .....	7
6-1. MAXIMUM RATINGS .....	7
6-2. ELECTRICAL CHARACTERISTICS .....	8
<b>7. RELIABILITY</b> .....	11
7-1. ENGINEERING SAMPLE FLOW CHART .....	11
7-2. TEST ITEM & CONDITION .....	12
<b>8. REFLOW CONDITION</b> .....	13
<b>9. RECOMMENDED PCB DIMENSIONS</b> .....	13
<b>10. CAUTION</b> .....	14
<b>11. PACKING</b> .....	15
11-1. DIMENSIONS .....	15
11-2. REELING QUANTITY .....	16
11-3. TAPING STRUCTURE .....	16
11-4. INNER BOX(Reel Packing) STRUCTURE .....	17
11-5. OUTER BOX STRUCTURE .....	18
<b>12. TAPE SPECIFICATIONS</b> .....	19
<b>13. RoHS DATA</b> .....	20

## 1. REVISION HISTORY

000	July 30, 2013	All Page	Make specification
-----	---------------	----------	--------------------

## 2. DEFINITION

2-1. PART No.

**SFWG00DB002**

①      ②      ③      ④      ⑤      ⑥

No.	EXPLANATION	
①	SAW Filter	
②	Design Type	
③	Center Frequency Filter1	1900MHz (1880 MHz ~ 1920MHz)
④	Balanced Filter	Input: Unbalanced 50 ohm Output: Unbalanced 50 ohm
⑤	Package size: 1.5×1.1mm <sup>2</sup>	
⑥	Design Revision (02 : Molding Type)	

2-2. APPLICATION: TD SCDMA B39, B34 1in2out type Dual Rx Filter. Unbalance type

## 3. PRECAUTIONS

3-1. This device should not be used in any type of fluid such as water, oil, organic solvent, etc.

3-2. This is a hermetic device.

MSL(Moisture Sensitive Level) is the '2a' level.

3-3. Ultrasonic cleaning shall be avoided.

3-4. Isopropyl Alcohol and Ethyl Alcohol can be used for cleaning. Contact us before using other cleaning solvents than above

3-5. This is an electrostatic sensitive device.

Please avoid static voltage during operation and storage.

3-6. Sudden change of temperature shall be avoided, deterioration of the characteristics can occur.

3-7. If any malfunction due to designing or manufacturing which is out of specification occurs within one year after the products have been delivered, the maker should exchange the defective products.

4. OUTLINE DRAWING & DIMENSIONS

[Unit: mm]

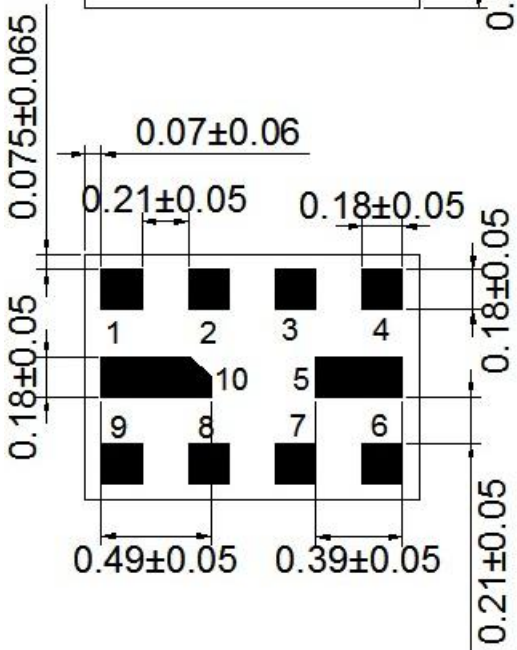
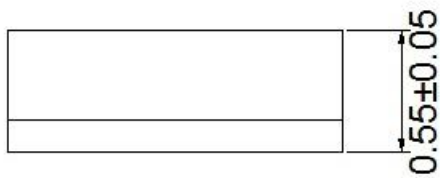
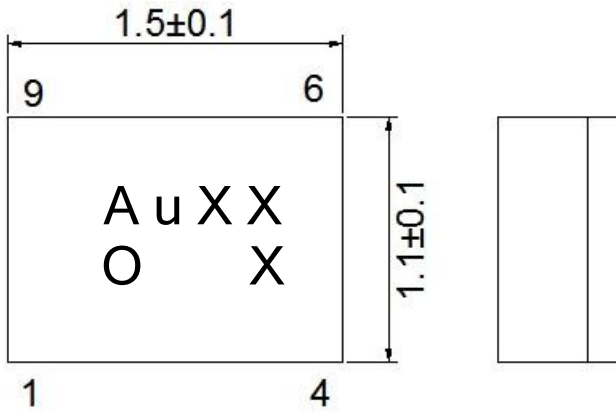

No.	Function
1	TD SCDMA B39 / B34 Input
9	TD SCDMA B39 Output
6	TD SCDMA B34 Output
Others	Ground

**5. MARKING**

**5-1. A u X X X**

- The 1<sup>st</sup> 2<sup>nd</sup> character 'Au' indicates the model name of SAW Filter SFWG00DB002.
- The 3<sup>rd</sup> character 'X' indicates the year and the month of manufacture.

Year	Month											
	1	2	3	4	5	6	7	8	9	10	11	12
<b>2013</b>	P	Q	R	S	T	U	V	W	X	Y	Z	a
<b>2014</b>	1	2	3	4	5	6	7	8	9	A	B	C
<b>2015</b>	D	E	F	G	H	I	J	K	L	M	N	O
<b>2016</b>	P	Q	R	S	T	U	V	W	X	Y	Z	a

※ This rotates by the 3 years.

- The 4<sup>th</sup>, 5<sup>th</sup> character 'X' indicates Lot No.

**5-2. O**

- This symbol indicates input pin 1.
- This indicates the producing center
  - : China,

**5-3. Marking: Laser Marking**

## 6. PERFORMANCE

### 6-1. MAXIMUM RATINGS

CHARACTERISTICS	RATINGS	UNITS
DC Permissive Voltage	5	V
Maximum Input Power	15	dBm
Operating Temperature Range	- 30 ~ +85	°C
Storage Temperature Range	- 40 ~ +85	°C

**6-2. ELECTRICAL CHARACTERISTICS**
**6-2-1. TABLE**

Ta = - 30 ~ +85°C

ITEM	UNIT	TD SCDMA B39				TD SCDMA B34			
		Freq. Range [MHz]	Min.	Typ. (25°C)	Max.	Freq. Range [MHz]	Min.	Typ. (25°C)	Max.
Insertion Loss	dB	1880~1920	-	1.7	2.3	2010~2025	-	1.9	2.5
Inband Ripple	dB	1880~1920	-	0.8	1.5	2010~2025	-	0.7	1.5
Input VSWR	-	1880~1920	-	1.6	2.3	2010~2025	-	1.4	2.3
Output VSWR	-	1880~1920	-	1.6	2.3	2010~2025	-	1.4	2.3
Absolute Attenuation	dB	1500 ~ 1750	25	30	-	1500 ~ 1750	27	33	-
	dB	1750 ~ 1805	25	29	-	1750 ~ 1805	28	35	-
	dB	1805 ~ 1840	22	29	-	1805 ~ 1850	30	36	-
	dB	2000 ~ 2135	20	24	-	1850 ~ 1950	28	35	-
	dB	2135 ~ 2350	22	27	-	1950 ~ 1970	10	22	-
						2050 ~ 2095	3.5	8	-
						2095~2350	30	35	-
Termination Impedance		Input: Unbal. 50 ohm //shunt 5.6nH Output: Unbal. 50 ohm//serie 1.0nH				Input: Unbal. 50ohm //shunt 5.6nH Output: Unbal. 50 ohm			



6-2-2. TEST FIXTURE

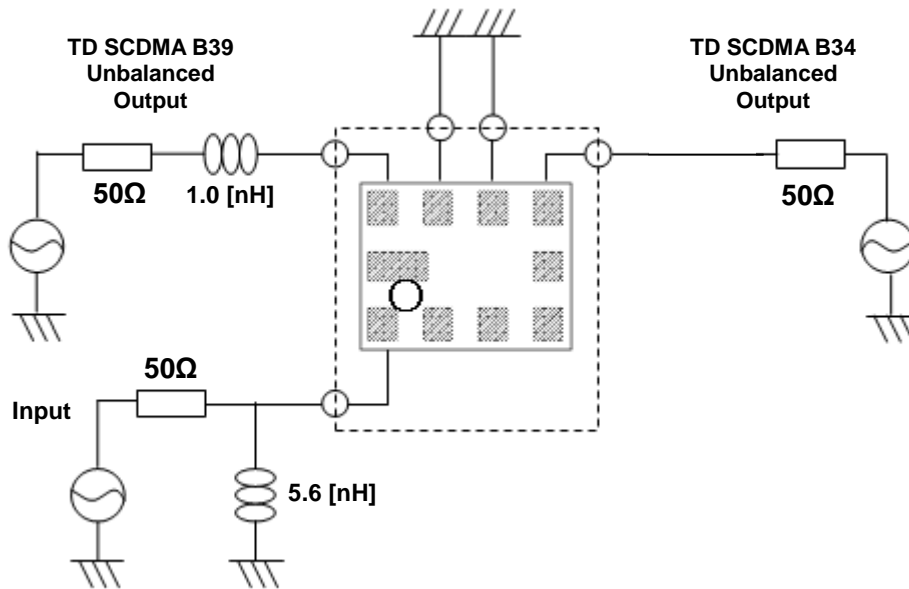

6-2-3. GRAPH

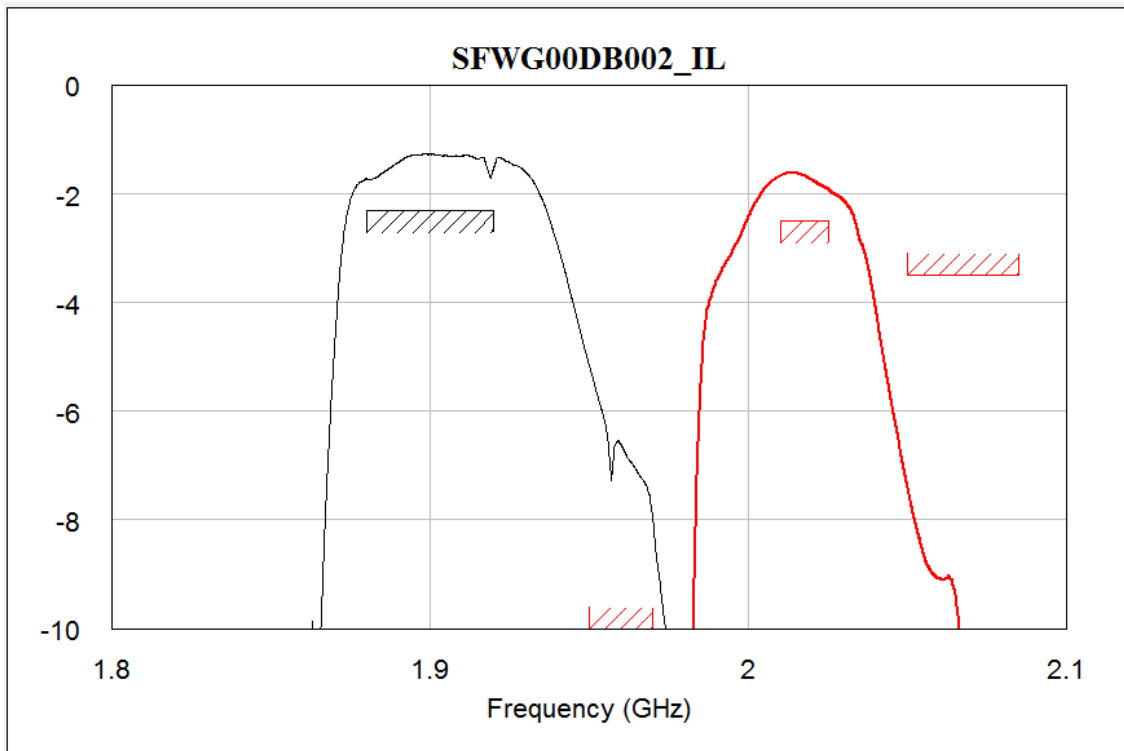
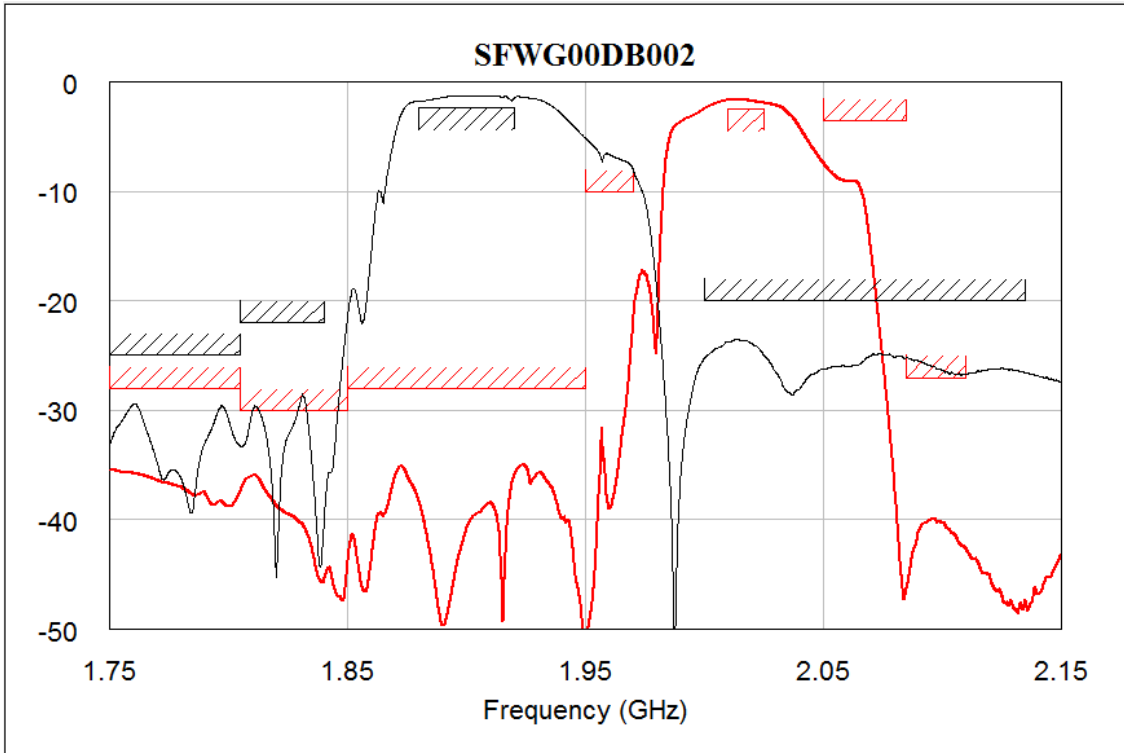

## 7. RELIABILITY

### 7-1. ENGINEERING SAMPLE FLOW CHART

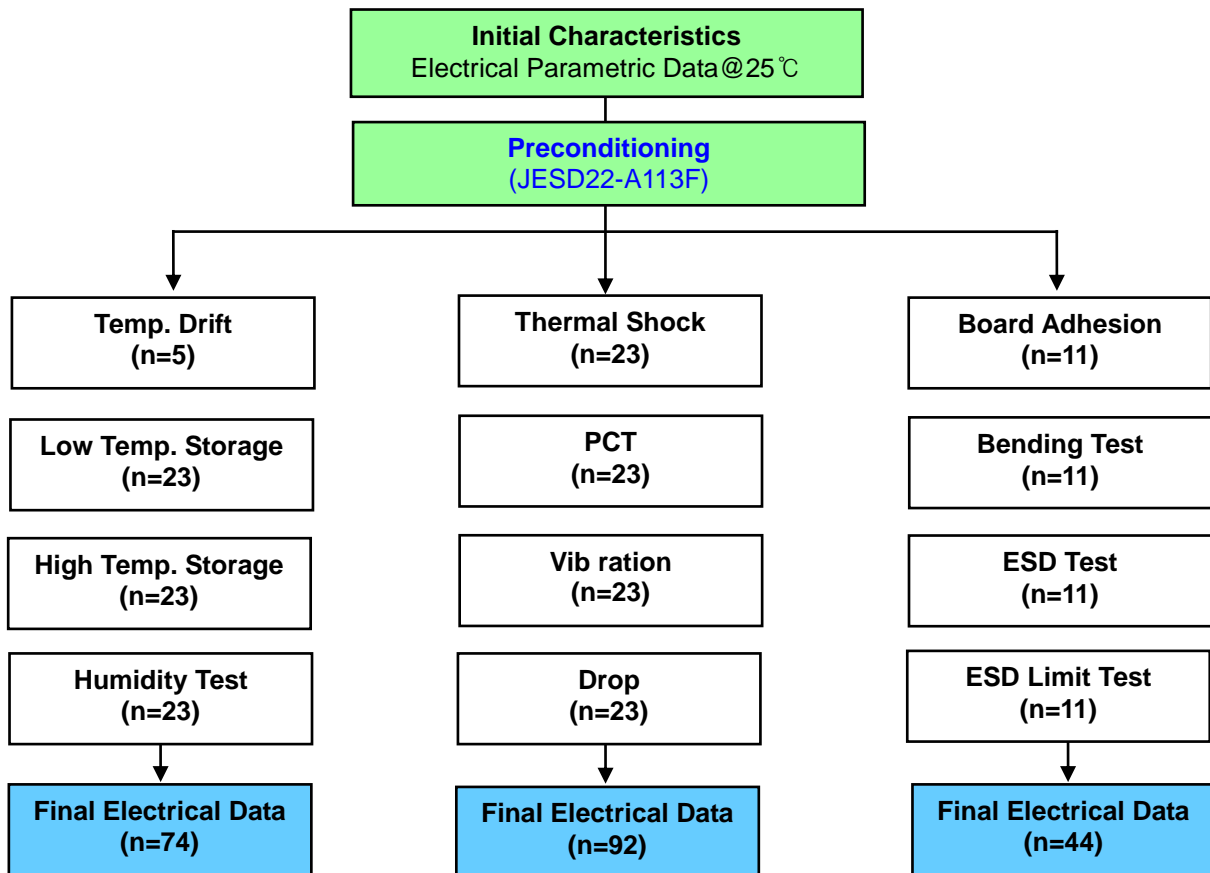

## 7-2. TEST ITEM &amp; CONDITION

CATEGORY	TEST ITEM	TEST CONDITION	REMARK
	Preconditioning	+125℃ 24hr Baking → +60℃ 60%RH 120hr → Reflow Test(3times)	JESD22A113F



Environment Test	Temp. Drift	-30℃ → +25℃ → +85℃	description
	High Temp. Storage	+85℃ 240hr	JESD22-A103C
	Low Temp. Storage	-40℃ 240hr	JESD22-A119
	High Temp. High Humidity Storage	+85℃ 85%RH 240hr	JESD22-A106B
	Thermal Shock	-40℃/30min ⇔ +85℃/30min , 100cycle	JESD22-A106A
	High Temp. Operating	+121℃ 100%RH 96hr	JESD22-A102C
Mechanical Test	Vibration Test (Random)	20 Hz~2000 Hz,0.053G <sup>2</sup> /Hz or 8gs RMS,15min/plane	IEC 68-2-36 Fdb
	Drop Test	152 cm 12times Steel floor JIG(110g~150g)	IEC 1178-1.4.8.9
	Board Adhesion	0.5 mm/sec 1point push	IEC 68-2-21 Ue3
	Bending Test	0.5 mm/sec 3times -PCB : FR4 , PCB SIZE : 100*40 mm	IEC 68-2-21 Ue3
Physical Test	Solder Heat Resistance	±250V,C=100pF,R=1.5 kΩ,1times	IEC 68-2-21 Ue3
	static marginal test	C=100pF,R=1.5 kΩ,1times(demand of customer)	JESD22-A114F

8. REFLOW CONDITION

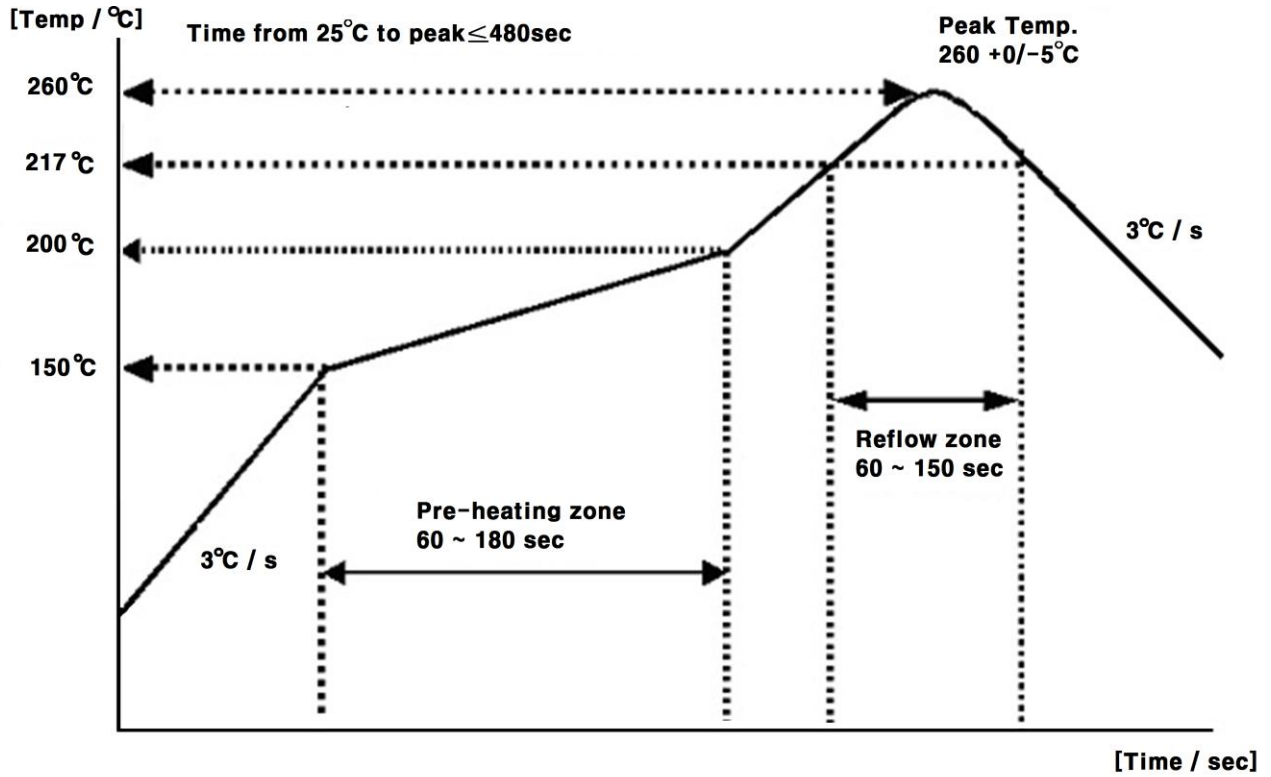

9. RECOMMENDED PCB DIMENSIONS

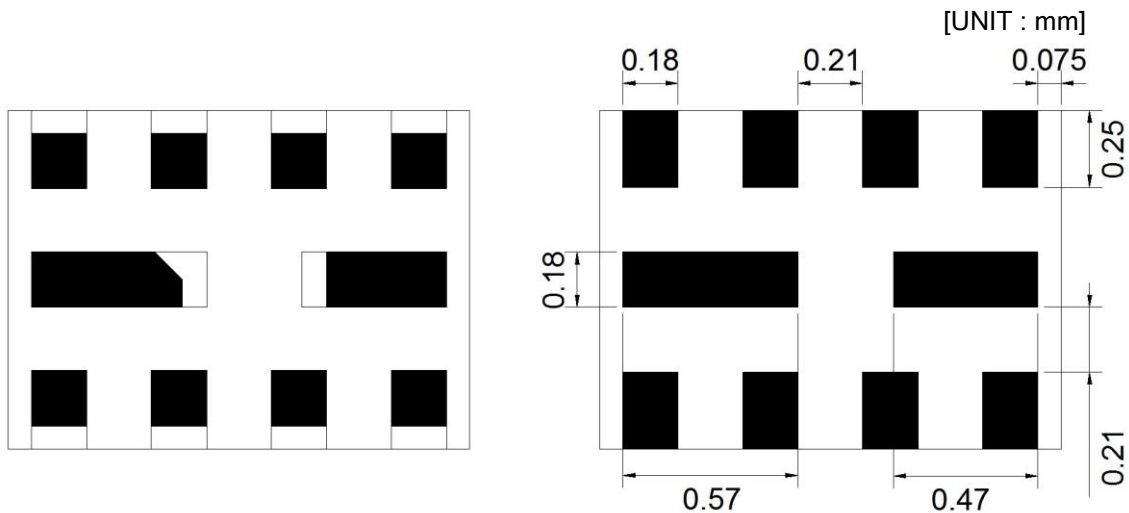

< SAW, X-ray Top View >

< PCB, X-ray Top View >

10. CAUTION

Moisture Sensitivity Device Caution (MSL LEVEL=2a)

1. Calculated shelf life in sealed bag : 12 month at < 40°C and < 90% relative Humidity(RH)
  2. Peak package body temperature : **260°C**
  3. After bag is opened, devices that will be subjected to reflow solder or other high temperature process must be
    - (a) Mounted within : 672 hours of factory conditions ≤30°C/60% RH, or
    - (b) Stored per J-STD-033
  4. Device require bake, before mounting, if :
    - (a) Humidity Indicator Card reads > 60% when read at 23±5°C
    - (b) 3(a) or 3(b) are not met
  5. If baking is required, refer to IPC/JEDEC J-STD-033 for bake procedure
- Note : Level and body temperature defined by IPC/JEDEC J-STD-020

Aluminum Pack (310mmX370mm)



HIC(Humidity Indication Card)

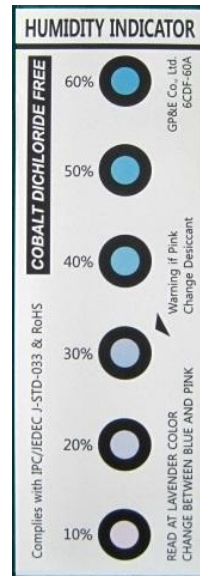

10 to 60% RH

11. PACKING

11-1. DIMENSIONS

- Carrier Tape

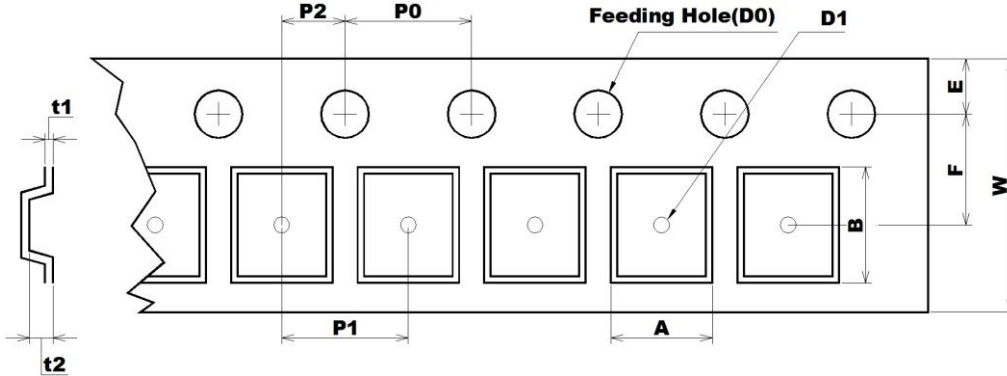

[Unit: mm]

A	B	D0	D1	E	F	P0	P1	P2	t1	t2	W
1.35	1.75	Ø1.50	Ø0.50	1.75	3.50	4.00	4.00	2.00	0.25	0.70	8.00
+0.05	+0.05	+0.10	+0.05	+0.10	+0.05	+0.10	+0.10	+0.05	+0.02	+0.07	+0.30
-0.05	-0.05	-0.00	-0.05	-0.10	-0.05	-0.10	-0.10	-0.05	-0.02	-0.07	-0.10

- Reel

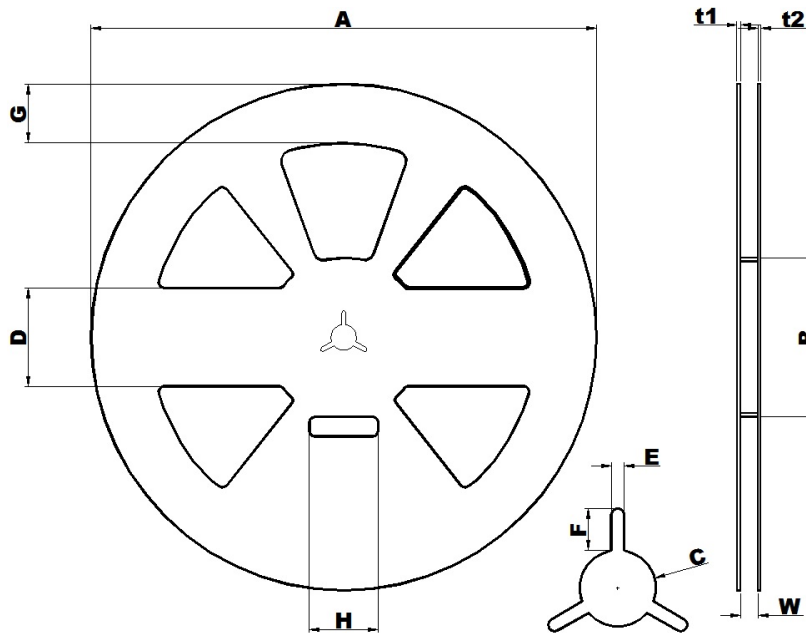

[Unit: mm]

A	B	C	D	E	F	G	H	t1	t2	W
Ø 258.0	Ø 81.0	Ø 13.0	50.0	2.2	7.0	30.0	35.0	1.8	1.5	9.0
+1.0	+1.0	+0.5	+0.8	+0.3	+0.5	+0.8	+1.0	+0.5	+0.5	+1.0
-0.5	-1.0	-0.5	-0.8	-0.3	-0.5	-0.8	-1.0	-0.5	-0.5	-0.5

- The product shall be packed properly not to damaged during transportation and storage.

TD SCDMA B39 Rx 1900MHz  
 TD SCDMA B34 Rx 2017.5MHz

1.5×1.1×0.55mm<sup>3</sup> 10pin lay-out

Version: 000

11-2. REELING QUANTITY

10 inch reel : 8,000 pcs/reel

11-3. TAPING STRUCTURE

11-3-1. The tape shall be wound around the reel in direction shown below.

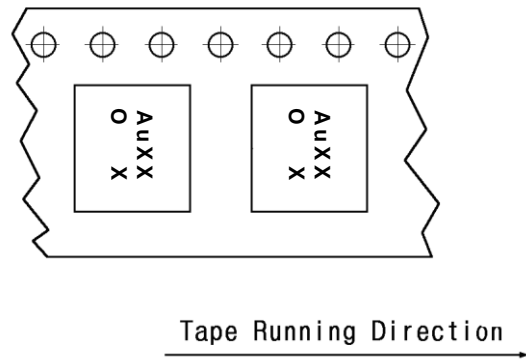
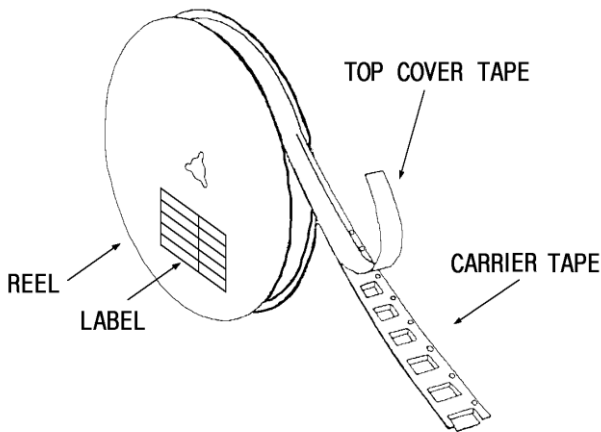

11-3-2. BAR CODE LABEL



- |   |   |                    |
|---|---|--------------------|
| ① |  | MODEL NAME BARCODE |
| ② | SFH836AQ101   | Model Name         |
| ③ | RLYC12563   | Reel number        |
| ④ | 8,000 / qAFYU   | Quantity / Marking |



1-3-3. Leader part and vacant position specifications.

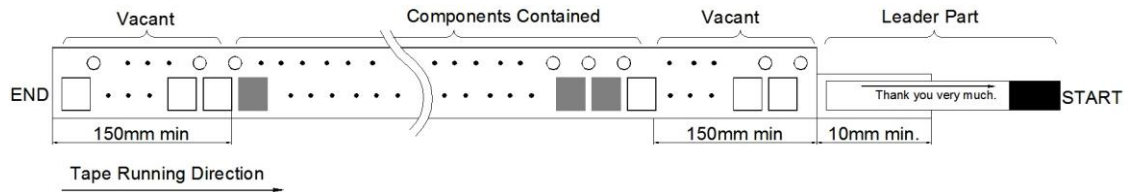

11-4. INNER BOX(Reel Packing) STRUCTURE

Material: Polycarbonate

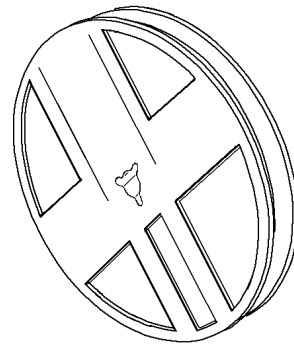

Material: Polyethylene + Aluminium  
 Size: 310×370mm<sup>2</sup>

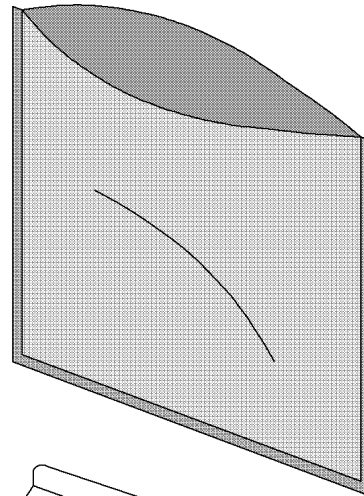

Material: Paper  
 Size: (D)260×(W)37×(H)265mm<sup>3</sup>

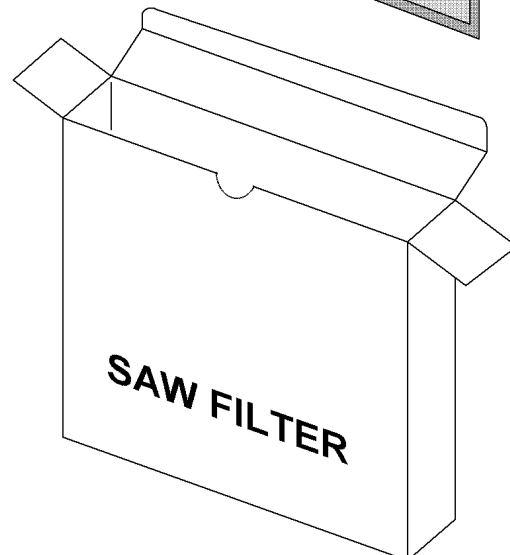

11-5. OUTER BOX STRUCTURE

Material: Paper

TYPE	SIZE(mm)			Inner Box #
	a	b	c	
A	270	240	275	6 boxes

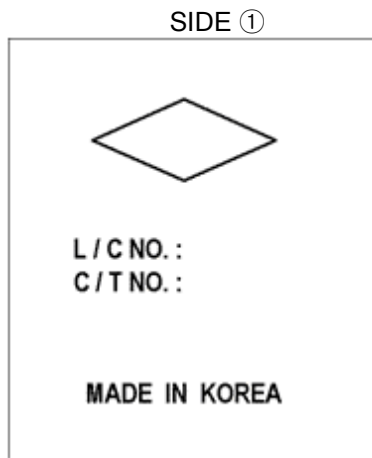
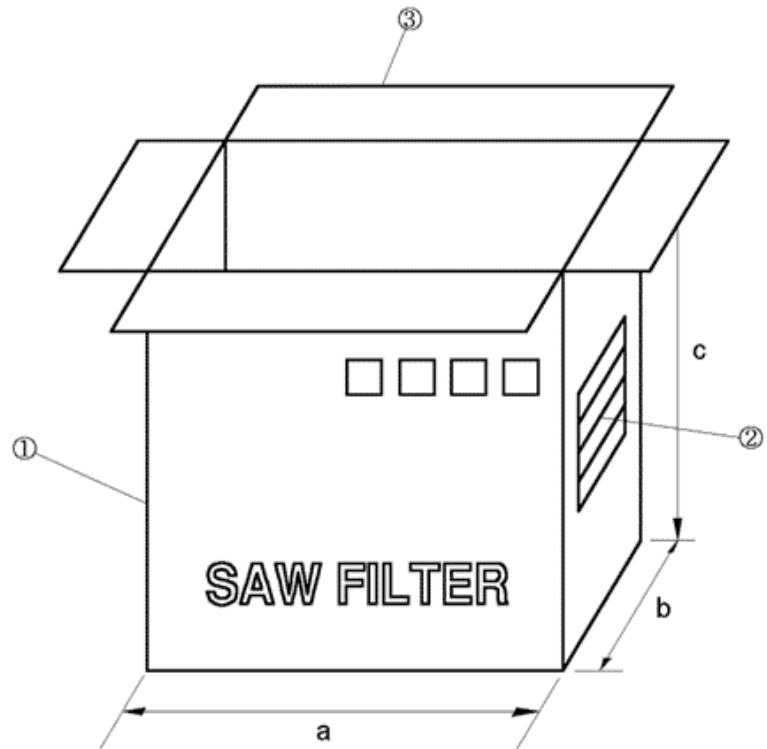

SIDE ②

MODEL	
Q'TY	EA
USER	
DATE	. . .

- SIDE is the same as front side.

## 12. TAPE SPECIFICATIONS

12-1. Tensile Strength of Carrier Tape: 4.4N/mm width

12-2. Top Cover Tape Adhesion (See the below figure)

- pull of angle: 0~15 degree
- speed: 300mm/min.
- force: 20~70g

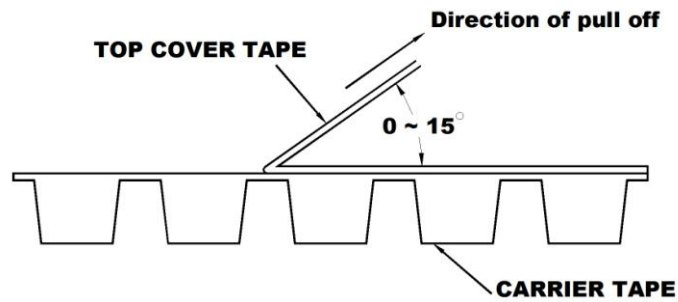

13. RoHS DATA



Test Report No. F690101/LF-CTSAYAA13-31939

Issued Date: 2013. 07. 08 Page 1 of 6

To: WISOL CO., LTD.  
 373-7  
 Gajang-dong  
 Osan-si  
 Gyeonggi-do  
 Korea

The following merchandise was submitted and identified by the client as :

SGS File No. : AYAA13-31939  
 Product Name : SAW FILTER  
 Item No./Part No. : N/A  
 Received Date : 2013. 07. 03  
 Test Period : 2013. 07. 04 to 2013. 07. 08  
 Buyer(s) : SAMSUNG  
 Test Results : For further details, please refer to following page(s)  
 Test Performed : SGS Korea tested the sample(s) selected by applicant with following results.  
 Test Comments : By the applicant's specific request, the sampling and testing was performed only for the part indicated in the photo without disassembly.

Timothy Jeon  
 Jinhee Kim  
 Cindy Park  
 Jerry Jung/ Testing Person

SGS Korea Co., Ltd.



Jeff Jang / Chemical Lab Mgr

Document is issued by the Company subject to the General Conditions of Service (printed material) available on request or accessible at <http://www.sgs.com/chemical/conditions.htm> and, for electronic format documents, subject to Terms and Conditions for Electronic Documents at <http://www.sgs.com/chemical/electronic.htm>. Operator is aware of the limitation of liability, indemnification and jurisdiction clause outlined therein. Any issue of the document is subject to the information contained therein reflects the Company's findings at the time of its issuance only and within the limits of Client's instructions. If the Company's work responsibility is to be Client and this document does not constitute parties to a transaction from existing at the time and obligations under the transaction documents. This document cannot be reproduced except in full without prior written approval of the Company. Any unauthorized alteration or distribution of the content or appearance of this document is considered a violation and offenders may be prosecuted to the fullest extent of the law. All information related to the results shown in this test report refer only to the sample(s) tested and each sample(s) are retained for 30 days only.



**Test Report No.** F690101/LF-CTSAYAA13-31939

Issued Date: 2013. 07. 08 Page 2 of 6

**Sample No.** : AYAA13-31939.001  
**Sample Description** : SAW FILTER  
**Item No./Part No.** : N/A  
**Materials** : N/A

**Heavy Metals**

Test Items	Unit	Test Method	MDL	Results
Cadmium (Cd)	mg/kg	With reference to IEC 62321:2008, ICP	0.5	N.D.
Lead (Pb)	mg/kg	With reference to IEC 62321:2008, ICP	5	N.D.
Mercury (Hg)	mg/kg	With reference to IEC 62321:2008, ICP	2	N.D.
Hexavalent Chromium (Cr VI)	mg/kg	With reference to IEC 62321:2008, UV-VIS	1	N.D.
Antimony (Sb)	mg/kg	With reference to EPA 3052(1996), US EPA 6010B(1996), ICP	10	N.D.

**Flame Retardants-PBBs/PBDEs**

Test Items	Unit	Test Method	MDL	Results
Monobromobiphenyl	mg/kg	With reference to IEC 62321:2008, GC-MS	5	N.D.
Dibromobiphenyl	mg/kg	With reference to IEC 62321:2008, GC-MS	5	N.D.
Tri bromobiphenyl	mg/kg	With reference to IEC 62321:2008, GC-MS	5	N.D.
Tetrabromobiphenyl	mg/kg	With reference to IEC 62321:2008, GC-MS	5	N.D.
Pentabromobiphenyl	mg/kg	With reference to IEC 62321:2008, GC-MS	5	N.D.
Hexabromobiphenyl	mg/kg	With reference to IEC 62321:2008, GC-MS	5	N.D.
Heptabromobiphenyl	mg/kg	With reference to IEC 62321:2008, GC-MS	5	N.D.
Octabromobiphenyl	mg/kg	With reference to IEC 62321:2008, GC-MS	5	N.D.
Nonabromobiphenyl	mg/kg	With reference to IEC 62321:2008, GC-MS	5	N.D.
Decabromobiphenyl	mg/kg	With reference to IEC 62321:2008, GC-MS	5	N.D.
Monobromodiphenyl ether	mg/kg	With reference to IEC 62321:2008, GC-MS	5	N.D.
Dibromodiphenyl ether	mg/kg	With reference to IEC 62321:2008, GC-MS	5	N.D.
Tri bromodiphenyl ether	mg/kg	With reference to IEC 62321:2008, GC-MS	5	N.D.
Tetrabromodiphenyl ether	mg/kg	With reference to IEC 62321:2008, GC-MS	5	N.D.
Pentabromodiphenyl ether	mg/kg	With reference to IEC 62321:2008, GC-MS	5	N.D.
Hexabromodiphenyl ether	mg/kg	With reference to IEC 62321:2008, GC-MS	5	N.D.
Heptabromodiphenyl ether	mg/kg	With reference to IEC 62321:2008, GC-MS	5	N.D.
Octabromodiphenyl ether	mg/kg	With reference to IEC 62321:2008, GC-MS	5	N.D.
Nonabromodiphenyl ether	mg/kg	With reference to IEC 62321:2008, GC-MS	5	N.D.

NOTE:

- (1) N.D. = Not detected, (<MDL)
- (2) mg/kg = ppm
- (3) MDL = Method Detection Limit
- (4) - = No regulation
- (5) Negative = Undetectable / Positive = Detectable
- (6) \*\* = Qualitative analysis (No Unit)
- (7) \* = Boiling-water-extraction:  
 Negative = Absence of CrVI coating  
 Positive = Presence of CrVI coating; the detected concentration in boiling-water-extraction solution is equal or greater than 0.02 mg/kg with 50 cm<sup>2</sup> sample surface area.

This document is issued to the Company subject to the General Conditions of Service printed hereon, available on request or accessible at <http://www.sgs.com/ClientConditions.aspx>, and, for electronic format documents, subject to Terms and Conditions for Electronic Documents at <http://www.sgs.com/ClientConditions.aspx>. Attention is drawn to the limitation of liability, indemnification and jurisdiction clauses printed hereon. Any holder of the document is advised that information contained hereon reflects the Company's findings at the time of its intervention only and within the limits of Client's instructions, if any. The Company's sole responsibility is to its Client and the document does not constitute notice to a third party from assuming all their rights and obligations under the transaction documents. This document cannot be reproduced except in full, without prior written approval of the Company. Any unauthorized alteration, forgery or falsification of the content or appearance of this document is unlawful and offenders may be prosecuted to the fullest extent of the law. Unless otherwise stated the results shown in this report refer only to the samples tested and each sample(s) are retained for 90 days only.



**Test Report No.** F690101/LF-CTSAYAA13-31939

Issued Date: 2013. 07. 08 Page 3 of 6

**Sample No.** : AYAA13-31939.001  
**Sample Description** : SAW FILTER  
**Item No./Part No.** : N/A  
**Materials** : N/A

**Flame Retardants-PBBs/PBDEs**

Test Items	Unit	Test Method	MDL	Results
Decabromodiphenyl ether	mg/kg	With reference to IEC 62321:2008, GC-MS	5	N.D.

**Halogen Content**

Test Items	Unit	Test Method	MDL	Results
Bromine(Br)	mg/kg	BS EN 14582:2007 , IC	30	N.D.
Chlorine(Cl)	mg/kg	BS EN 14582:2007 , IC	30	N.D.

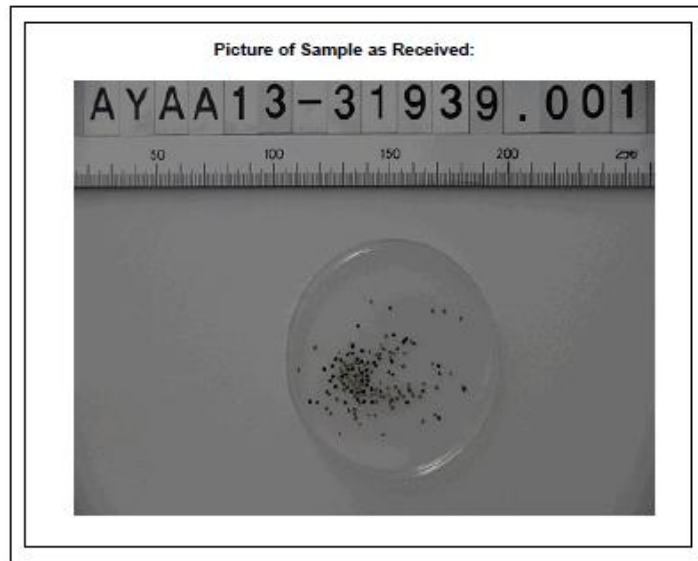

**NOTE:**

- (1) N.D. = Not detected.(<MDL)
- (2) mg/kg = ppm
- (3) MDL = Method Detection Limit
- (4) - = No regulation
- (5) Negative = Undetectable / Positive = Detectable
- (6) \*\* = Qualitative analysis (No Unit)
- (7) \* = Boiling-water-extraction:  
 Negative = Absence of CrVI coating  
 Positive = Presence of CrVI coating; the detected concentration in boiling-water-extraction solution is equal or greater than 0.02 mg/kg with 50 cm2 sample surface area.

This document is issued by the Company subject to the General Conditions of Service printed hereon, available on request at <http://www.sgs.com/ServiceConditions.pdf>, for electronic format documents, subject to Terms and Conditions for Electronic Documents at <http://www.sgs.com/ServiceConditions.pdf>. Reference is drawn to the limitation of liability, indemnification and jurisdiction clause without breach. Any holder of this document is advised that information contained herein reflects the Company's findings at the time of its issuance only and within the limits of Client's instructions. If any. The Company's sole responsibility is to the Client and this document does not constitute either a transaction nor involving at their rights and obligations under the transaction documents. This document cannot be reproduced except in full without prior written approval of the Company. Any unauthorized alteration, forgery or falsification of the content or appearance of this document is illegal and punishable by law. References may be made to the latest version of the law. Client's attention is drawn to the fact that only the results reported here only to the company tested and such results are related to 3C days only.



Test Report No. F690101/LF-CTSAYAA13-31939

Issued Date: 2013. 07. 08 Page 4 of 6

Testing Flow Chart for RoHS: Cd/Pb/Hg/Cr<sup>6+</sup> /PBBs&PBDEs Testing

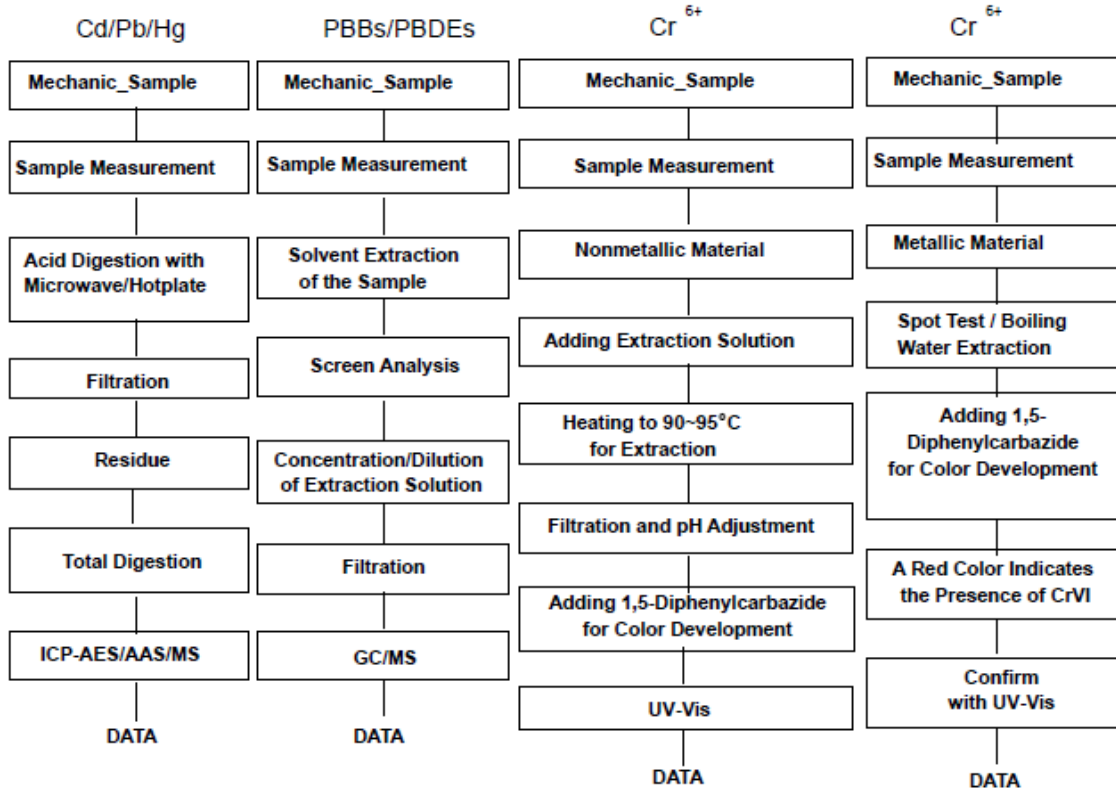

The samples were dissolved totally by pre-conditioning method according to above flow chart for Cd,Pb,Hg.  
 Section Chief : Gilsae Yi

NOTE:

- (1) N.D. = Not detected.(<MDL)
- (2) mg/kg = ppm
- (3) MDL = Method Detection Limit
- (4) - = No regulation
- (5) Negative = Undetectable / Positive = Detectable
- (6) \*\* = Qualitative analysis (No Unit)
- (7) \* = Boiling-water-extraction:  
 Negative = Absence of CrVI coating  
 Positive = Presence of CrVI coating: the detected concentration in boiling-water-extraction solution is equal or greater than 0.02 mg/kg with 50 cm2 sample surface area.

The document is issued by the Company subject to the General Conditions of Service (attached herewith) available on request or accessible at <http://www.sgs.com/Products/Chemical/Chemical.htm> for electronic format documents subject to Terms and Conditions for Electronic Documents at <http://www.sgs.com/Products/Chemical/Chemical.htm>. Attention is drawn to the limitation of liability, indemnification and jurisdiction clause defined therein. Any value of the document is subject to the information contained therein which is the Company's finding at the time of its intervention only and within the limits of Client's instructions. If any of the Company's sole responsibility is to the Client and the document does not constitute parties to a transaction from accepting all their rights and obligations under the transaction documents. The document cannot be reproduced without the written prior written approval of the Company. Any unauthorized alteration, forgery or falsification of the content or appearance of this document is unlawful and offenders may be prosecuted to the fullest extent of the law. (Some references within the report show the results shown in this test report only for the secondary tested and not necessarily are related to 30 days only.)

SGS Korea Co., Ltd.

322, The O valley, 555-9, Hoge-dong, Dongan-gu, Anyang-si, Gyeonggi-do, Korea 431-080  
 t +82 (0)31 4808 000 f +82 (0)31 4808 050 <http://www.sgsksh.co.kr> [www.kr.sgs.com/sgsksh](http://www.kr.sgs.com/sgsksh)

F052 Version5

Member of the SGS Group (Société Générale de Surveillance)





Test Report No. F690101/LF-CTSAYAA13-31939

Issued Date: 2013. 07. 08 Page 5 of 6

Flow Chart for Inorganic Elements Testing

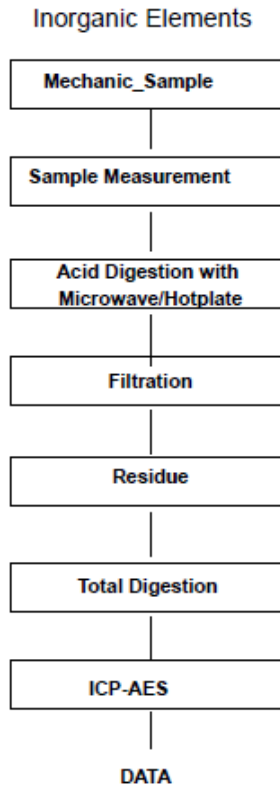

NOTE:

- (1) N.D. = Not detected.(<MDL)
- (2) mg/kg = ppm
- (3) MDL = Method Detection Limit
- (4) - = No regulation
- (5) Negative = Undetectable / Positive = Detectable
- (6) \*\* = Qualitative analysis (No Unit)
- (7) \* = Boiling-water-extraction:  
Negative = Absence of CrVI coating  
Positive = Presence of CrVI coating; the detected concentration in boiling-water-extraction solution is equal or greater than 0.02 mg/kg with 50 cm<sup>2</sup> sample surface area.

\* Document is issued by the Company subject to its General Conditions of Service printed hereon, available on request or accessible at <http://www.sgs.com/ClientandConditions.aspx> and, for electronic format documents, subject to Terms and Conditions for Electronic Documents at <http://www.sgs.com/ClientandConditions.aspx>. Selection is given to the location of facility, instrumentation and jurisdiction issues without breach. Any failure of the document is subject that information contained herein reflects the Company's findings at the time of its intervention only and within the limits of Client's instructions. If the Company's sole responsibility is to the Client and the document does not constitute part of a transaction, from receiving of this report and obligations under the transaction documents. The document cannot be reproduced, stored in a retrieval system or transmitted in any form or by any means, without prior written approval of the Company. Any unauthorized alteration, forgery or falsification of the content or appearance of this document is unlawful and offenders may be prosecuted to the fullest extent of the law. See also disclaimer signed for the results shown in this test report when only the sample(s) tested and each sample(s) are retained for 30 days only.





Test Report No. F690101/LF-CTSAYAA13-31939

Issued Date: 2013. 07. 08 Page 6 of 6

Flow Chart for Halogen Test

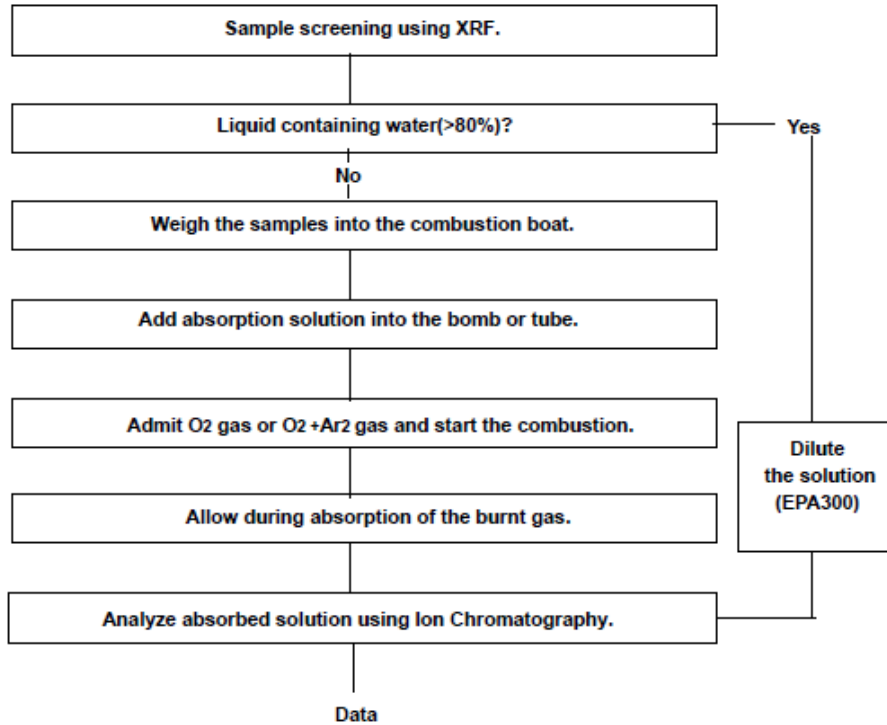

\*\*\* End \*\*\*

NOTE:

- (1) N.D. = Not detected.(<MDL)
- (2) mg/kg = ppm
- (3) MDL = Method Detection Limit
- (4) - = No regulation
- (5) Negative = Undetectable / Positive = Detectable
- (6) \*\* = Qualitative analysis (No Unit)
- (7) \* = Boiling-water-extraction:  
Negative = Absence of CrVI coating  
Positive = Presence of CrVI coating; the detected concentration in boiling-water-extraction solution is equal or greater than 0.02 mg/kg with 50 cm<sup>2</sup> sample surface area.

This document is issued by the Company subject to its General Conditions of Service (printed or online), available on request or accessible at <http://www.sgs.com/ChinaandSoutheastAsia> and, for electronic format documents, subject to Terms and Conditions for Electronic Documents at <http://www.sgs.com/ChinaandSoutheastAsia>. Attention is drawn to the limitation of liability, indemnification and jurisdiction issues defined therein. Any holder of this document is advised that information contained herein reflects the Company's findings at the time of its intervention only and within the limits of Client's instructions. It is the Client's sole responsibility as to the Client and this document does not constitute advice in a transaction from assessing all their rights and obligations under the transaction documents. This document cannot be reproduced except in full, without prior written approval of the Company. Any unauthorized alteration, forgery or falsification of the content or appearance of this document is unlawful and offenders may be prosecuted to the fullest extent of the law. (See also below signed the results shown in the test report only refer to the samples tested and each sample) are retained for 30 days only.