

GENERAL DESCRIPTION

The SGM4056 is a cost-effective, fully integrated high input voltage single-cell Li-Ion battery charger. The charger uses a CC/CV charge profile required by Li-Ion battery. The charger accepts an input voltage up to 26.5V but is disabled when the input voltage exceeds the OVP threshold, typically 6.8V (SGM4056-6.8) or 10.5V (SGM4056-10.5), to prevent excessive power dissipation. The 26.5V rating eliminates the over-voltage protection circuit required in a low input voltage charger.

The charge current and the end-of-charge (EOC) current are programmable with external resistors. When the battery voltage is lower than typically 2.55V, the charger preconditions the battery with typically 18% of the programmed charge current. When the charge current reduces to the programmable EOC current level during the CV charge phase, an EOC indication is provided by the $\overline{\text{CHG}}$ pin, which is an open-drain output. An internal thermal foldback function protects the charger from any thermal failure.

Two indication pins ($\overline{\text{PPR}}$ and $\overline{\text{CHG}}$) allow simple interface to a microprocessor or LEDs. When no adapter is attached or when disabled, the charger draws less than 1 μ A leakage current from the battery.

The SGM4056 is available in Green TDFN-3 \times 3-8L, TDFN-2 \times 3-8L, TDFN-2 \times 2-8L and SOIC-8 (Exposed Pad) packages and is rated over the -40°C to +85°C temperature range.

FEATURES

- **Complete Charger for Single-Cell Li-Ion or Polymer Batteries**
- **Integrated Pass Element and Current Sensor**
- **No External Blocking Diode Required**
- **Low Component Count and Cost**
- **Programmable Charge Current**
- **Programmable End-of-Charge Current**
- **Charge Current Thermal Foldback for Thermal Protection**
- **2.55V Trickle Charge Threshold**
- **6.8V Input Over-Voltage Protection for SGM4056-6.8**
- **10.5V Input Over-Voltage Protection for SGM4056-10.5**
- **26.5V Maximum Voltage for the Power Input**
- **Power Presence and Charge Indications**
- **Less than 1 μ A Leakage Current off the Battery When No Input Power Attached or Charger Disabled**
- **Available in Green TDFN-3 \times 3-8L, TDFN-2 \times 3-8L, TDFN-2 \times 2-8L and SOIC-8 (Exposed Pad) Packages**

APPLICATIONS

Mobile Phones
Blue-Tooth Devices
PDAs
MP3 Players
Stand-Alone Chargers
Other Handheld Devices

PACKAGE/ORDERING INFORMATION

MODEL	V _{OV} P (V)	PACKAGE DESCRIPTION	SPECIFIED TEMPERATURE RANGE	ORDER NUMBER	PACKAGE MARKING	PACKING OPTION
SGM4056	6.8V	TDFN-3×3-8L	-40°C to +85°C	SGM4056-6.8YTDB8G/TR	SGM G9DB XXXXX	Tape and Reel, 3000
	6.8V	TDFN-2×3-8L	-40°C to +85°C	SGM4056-6.8YTDC8G/TR	SGB XXXX	Tape and Reel, 3000
	6.8V	TDFN-2×2-8L	-40°C to +85°C	SGM4056-6.8YTDE8G/TR	SG7 XXXX	Tape and Reel, 3000
	6.8V	SOIC-8 (Exposed Pad)	-40°C to +85°C	SGM4056-6.8YPS8G/TR	SGM 4056-6.8YPS8 XXXXX	Tape and Reel, 2500
	10.5V	TDFN-3×3-8L	-40°C to +85°C	SGM4056-10.5YTDB8G/TR	SGM GADB XXXXX	Tape and Reel, 3000
	10.5V	TDFN-2×3-8L	-40°C to +85°C	SGM4056-10.5YTDC8G/TR	SGC XXXX	Tape and Reel, 3000
	10.5V	TDFN-2×2-8L	-40°C to +85°C	SGM4056-10.5YTDE8G/TR	SG8 XXXX	Tape and Reel, 3000
	10.5V	SOIC-8 (Exposed Pad)	-40°C to +85°C	SGM4056-10.5YPS8G/TR	SGM 4056-10.5YPS8 XXXXX	Tape and Reel, 2500

NOTE: XXXX = Date Code. XXXXX = Date Code and Vendor Code.

Green (RoHS & HSF): SG Micro Corp defines "Green" to mean Pb-Free (RoHS compatible) and free of halogen substances. If you have additional comments or questions, please contact your SGMICRO representative directly.

ABSOLUTE MAXIMUM RATINGS

VIN to GND -0.3V to 30V
 PPR, CHG, EN, IMIN, IREF, BAT to GND -0.3V to 6V
 Storage Temperature Range -65°C to +150°C
 Package Thermal Resistance
 TDFN-3×3-8L, θJA 84°C/W
 TDFN-2×3-8L, θJA 110°C/W
 TDFN-2×2-8L, θJA 118°C/W
 SOIC-8 (Exposed Pad), θJA 58°C/W
 Junction Temperature +150°C
 Lead Temperature (Soldering 10 sec) +260°C
 ESD Susceptibility
 HBM 4000V
 MM 200V
 CDM 1000V

RECOMMENDED OPERATING CONDITIONS

Operating Temperature Range -40°C to +85°C

OVERSTRESS CAUTION

Stresses beyond those listed may cause permanent damage to the device. Functional operation of the device at these or any other conditions beyond those indicated in the operational section of the specification is not implied. Exposure to absolute maximum rating conditions for extended periods may affect reliability.

ESD SENSITIVITY CAUTION

This integrated circuit can be damaged by ESD if you don't pay attention to ESD protection. SGMICRO recommends that all integrated circuits be handled with appropriate precautions. Failure to observe proper handling and installation procedures can cause damage. ESD damage can range from subtle performance degradation to complete device failure. Precision integrated circuits may be more susceptible to damage because very small parametric changes could cause the device not to meet its published specifications.

DISCLAIMER

SG Micro Corp reserves the right to make any change in circuit design, specification or other related things if necessary without notice at any time.

PIN CONFIGURATIONS

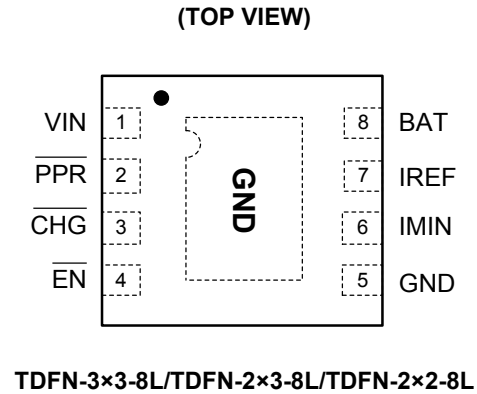
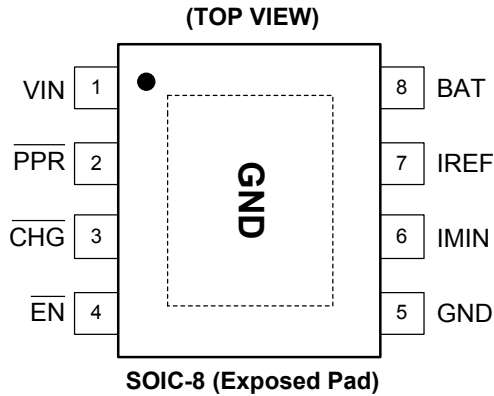

PIN DESCRIPTION

PIN	NAME	FUNCTION
1	VIN	Power Input. The absolute maximum input voltage is 26.5V. A 1μF or larger value X5R ceramic capacitor is recommended to be placed very close to the input pin for decoupling purpose. Additional capacitance may be required to provide a stable input voltage.
2	PPR	Open-drain Power Presence Indication. The open-drain MOSFET turns on when the input voltage is above the POR threshold but below the OVP threshold and off otherwise. This pin is capable to sink 15mA (MIN) current to drive an LED. The maximum voltage rating for this pin is 5.5V. This pin is independent on the EN pin input.
3	CHG	Open-drain Charge Indication. This pin outputs a logic low when a charge cycle starts and turns to high impedance when the end-of-charge (EOC) condition is qualified. This pin is capable to sink 15mA (MIN) current to drive an LED. When the charger is disabled, the CHG pin outputs high impedance.
4	EN	Enable Input. This is a logic input pin to disable or enable the charger. Drive to high to disable the charger. When this pin is driven to low or left floating, the charger is enabled. This pin has an internal 200kΩ pull-down resistor.
5	GND	System Ground.
6	IMIN	End-of-Charge (EOC) Current Programming Pin. Connect a resistor between this pin and the GND pin to set the EOC current. The EOC current I _{MIN} can be programmed by the following equation: $I_{MIN} = \frac{10070}{R_{IMIN}} - 0.5 \text{ (mA)}$ where R _{IMIN} is in kΩ. The programmable range covers 5% (or 10mA, whichever is higher) to 50% of IREF. When programmed to less than 5% or 10mA, the stability is not guaranteed.
7	IREF	Charge-Current Programming and Monitoring Pin. Connect a resistor between this pin and the GND pin to set the charge current limit determined by the following equation: $I_{REF} = \frac{12080}{R_{IREF}} - 4 \text{ (mA)}$ where R _{IREF} is in kΩ. The resistor should be located very close to this pin. The IREF pin voltage also monitors the actual charge current during the entire charge cycle, including the trickle, constant-current, and constant-voltage phases. When disabled, V _{IREF} = 0V.
8	BAT	Charger Output Pin. Connect this pin to the battery. A 1μF or larger X5R ceramic capacitor is recommended for decoupling and stability purposes. When the EN pin is pulled to logic high, the BAT output is disabled.

ELECTRICAL CHARACTERISTICS

(V_{IN} = 5V, R_{IMIN} = 243kΩ, T_A = +25°C, unless otherwise noted.)

PARAMETER		SYMBOL	CONDITIONS	MIN	TYP	MAX	UNITS
RECOMMENDED OPERATING CONDITIONS							
Maximum Supply Voltage						26.5	V
Operating Supply Voltage	SGM4056-6.8			4.55		6.10	V
	SGM4056-10.5			4.55		9.35	
Programmed Charge Current				100		900	mA
POWER-ON RESET							
Rising POR Threshold		V _{POR}	V _{BAT} = 3.0V, R _{IREF} = 120kΩ, use $\overline{\text{PPR}}$ to indicate the comparator output.	3.21	3.95	4.55	V
Falling POR Threshold		V _{POR}		2.86	3.60	4.35	V
VIN-BAT OFFSET VOLTAGE							
Rising Edge		V _{OS}	V _{BAT} = 4.5V, R _{IREF} = 120kΩ, use $\overline{\text{PPR}}$ pin to indicate the comparator output. ⁽¹⁾		110	200	mV
Falling Edge		V _{OS}		5	60		mV
OVER-VOLTAGE PROTECTION							
Over-Voltage Protection Threshold	SGM4056-6.8	V _{OV_P}	V _{BAT} = 4.3V, R _{IREF} = 120kΩ, use $\overline{\text{PPR}}$ to indicate the comparator output.	6.10	6.80	7.26	V
	SGM4056-10.5			9.35	10.50	11.15	
OVP Threshold Hysteresis	SGM4056-6.8	V _{OV_{PHYS}}		140	220	300	mV
	SGM4056-10.5			245	340	430	
STANDBY CURRENT							
BAT Pin Sink Current		I _{STANDBY}	Charger disabled or the input is floating			1	μA
VIN Pin Supply Current		I _{VIN}	V _{BAT} = 4.3V, R _{IREF} = 24.3kΩ, charger disabled		200	275	μA
VIN Pin Supply Current		I _{VIN}	V _{BAT} = 4.3V, R _{IREF} = 24.3kΩ, charger enabled		270	320	μA
VOLTAGE REGULATION							
Output Voltage	V _{CH}	R _{IREF} = 24.3kΩ, 4.55V < V _{IN} < 6.10V, charge current = 20mA		4.152	4.2	4.248	V
		R _{IREF} = 24.3kΩ, 4.55V < V _{IN} < 9.35V, charge current = 20mA		4.152	4.2	4.248	
PMOS On Resistance		R _{DS(ON)}	V _{BAT} = 3.8V, charge current = 500mA, R _{IREF} = 10kΩ		0.7		Ω
CHARGE CURRENT ⁽²⁾							
IREF Pin Output Voltage		V _{IREF}	V _{BAT} = 3.8V, R _{IREF} = 120kΩ	1.162	1.215	1.262	V
Constant Charge Current		I _{REF}	R _{IREF} = 24.3kΩ, V _{BAT} = 2.8V to 3.8V	440	500	560	mA
Trickle Charge Current		I _{TRK}	R _{IREF} = 24.3kΩ, V _{BAT} = 2.4V	55	90	135	mA
End-of-Charge Current		I _{MIN}	R _{IREF} = 24.3kΩ	20	40	75	mA
EOC Rising Threshold			R _{IREF} = 24.3kΩ	315	370	435	mA
PRECONDITIONING CHARGE THRESHOLD							
Preconditioning Charge Threshold Voltage		V _{MIN}	R _{IREF} = 24.3kΩ	2.46	2.55	2.65	V
Preconditioning Voltage Hysteresis		V _{MINHYS}	R _{IREF} = 24.3kΩ	20	100	190	mV

NOTES:

- The 4.5V V_{BAT} is selected so that the $\overline{\text{PPR}}$ output can be used as the indication for the offset comparator output indication. If the V_{BAT} is lower than the POR threshold, no output pin can be used for indication.
- The charge current can be affected by the thermal foldback function if the IC under the test setup cannot dissipate the heat.

ELECTRICAL CHARACTERISTICS (continued)(V_{IN} = 5V, R_{IMIN} = 243kΩ, T_A = +25°C, unless otherwise noted.)

PARAMETER	SYMBOL	CONDITIONS	MIN	TYP	MAX	UNITS
INTERNAL TEMPERATURE MONITORING						
Charge Current Foldback Threshold	T _{FOLD}			115		°C
LOGIC INPUT AND OUTPUTS						
$\overline{\text{EN}}$ Pin Logic Input High			1.5			V
$\overline{\text{EN}}$ Pin Logic Input Low					0.8	V
$\overline{\text{EN}}$ Pin Internal Pull Down Resistance			150	200	250	kΩ
$\overline{\text{CHG}}$ Sink Current when LOW		Pin Voltage = 1V	15	24		mA
$\overline{\text{CHG}}$ Leakage Current when High Impedance		V _{$\overline{\text{CHG}}$} = 5.5V			20	μA
$\overline{\text{PPR}}$ Sink Current when LOW		Pin Voltage = 1V	15	24		mA
$\overline{\text{PPR}}$ Leakage Current when High Impedance		V _{$\overline{\text{PPR}}$} = 5.5V			20	μA

TYPICAL PERFORMANCE CHARACTERISTICS

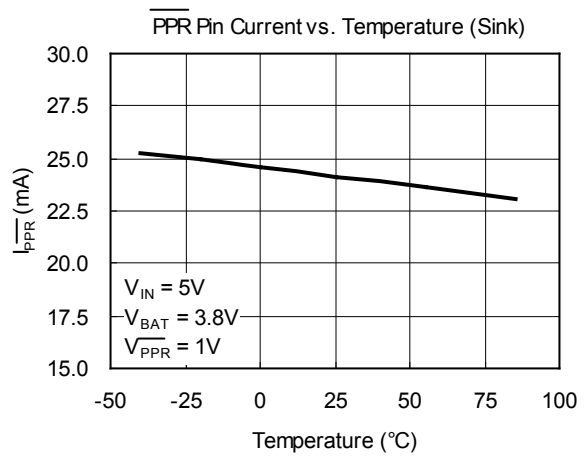
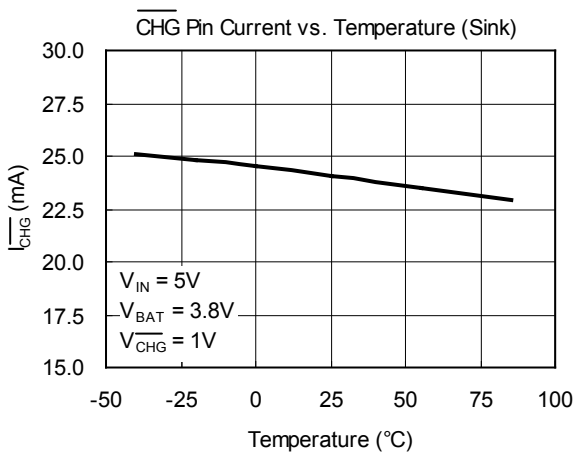
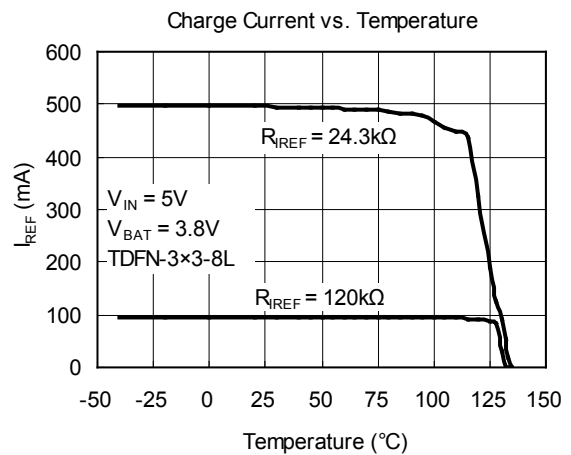
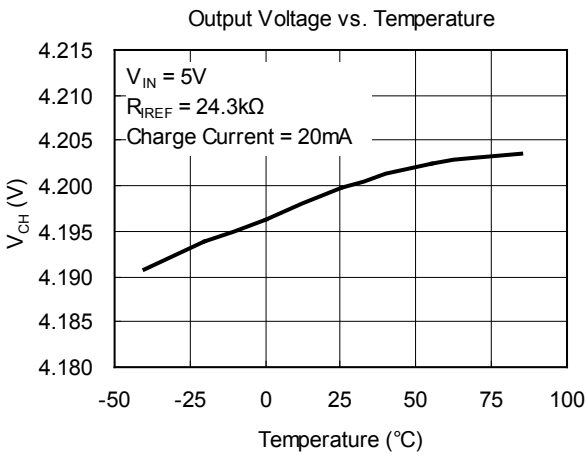
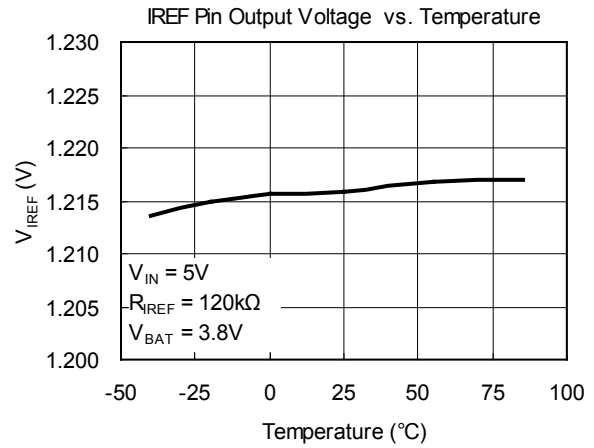
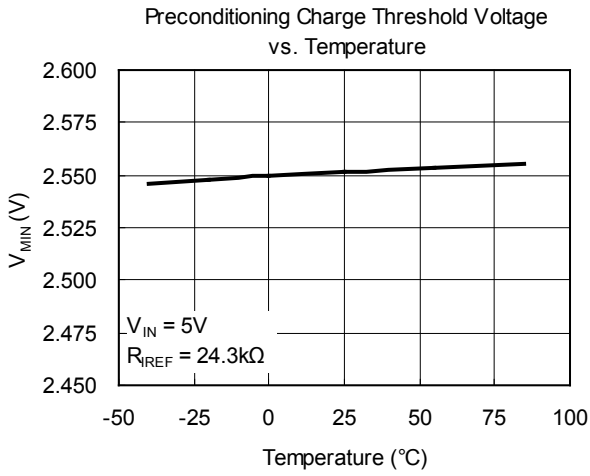

TYPICAL PERFORMANCE CHARACTERISTICS (continued)

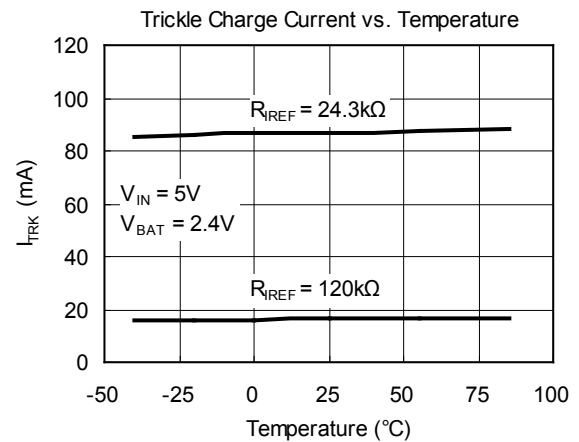
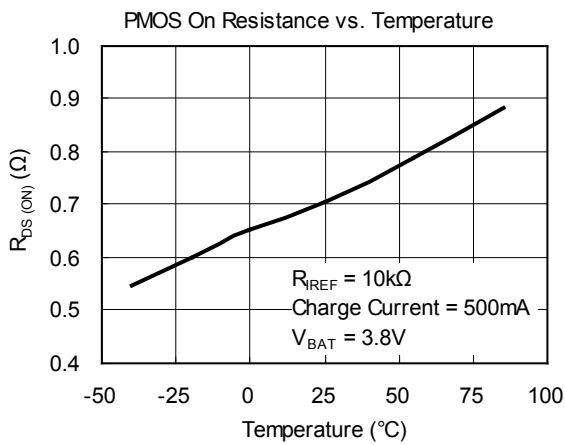
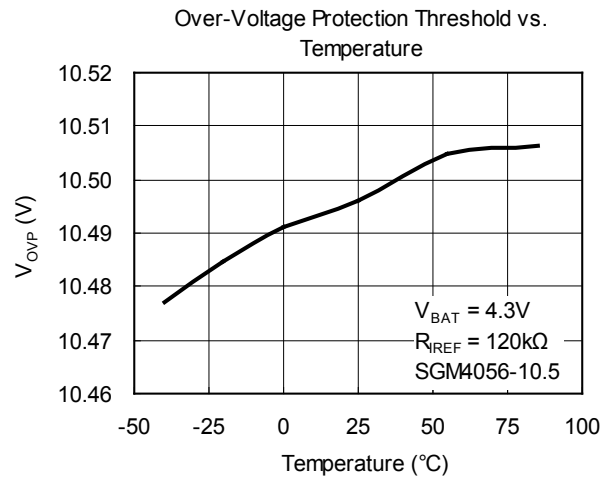
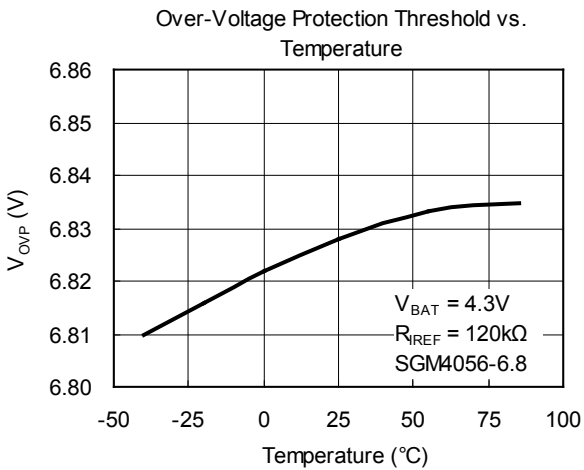
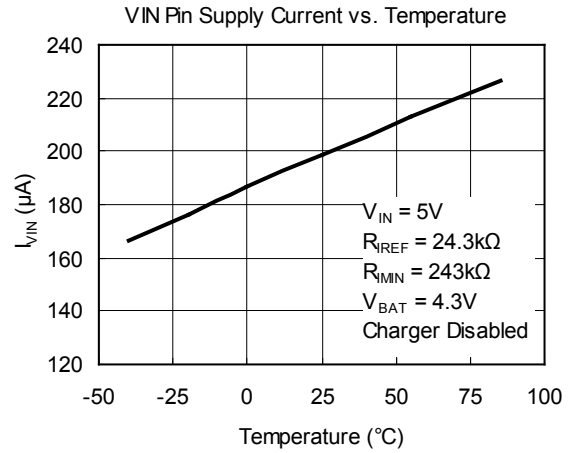
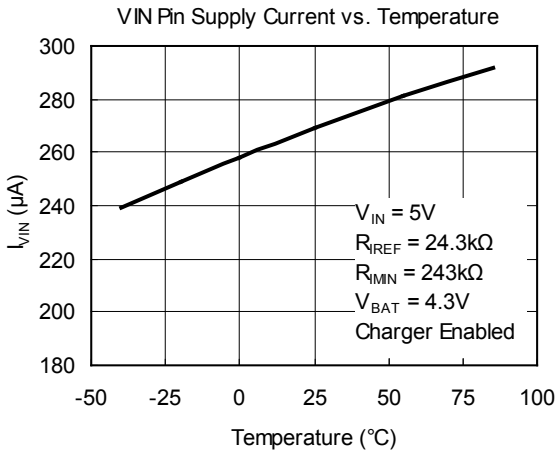

TYPICAL PERFORMANCE CHARACTERISTICS (continued)

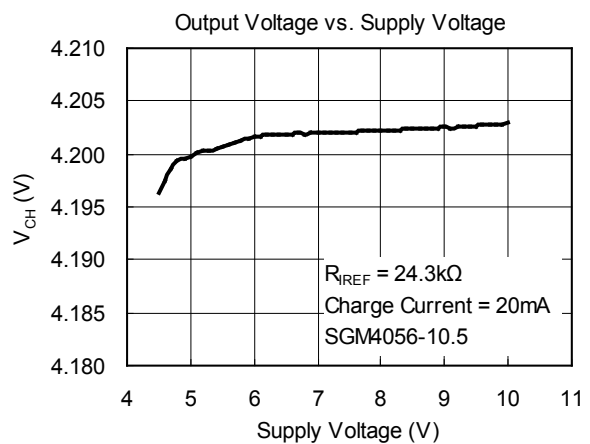
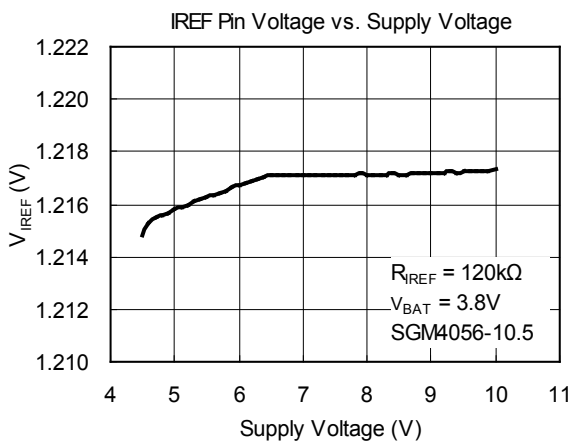
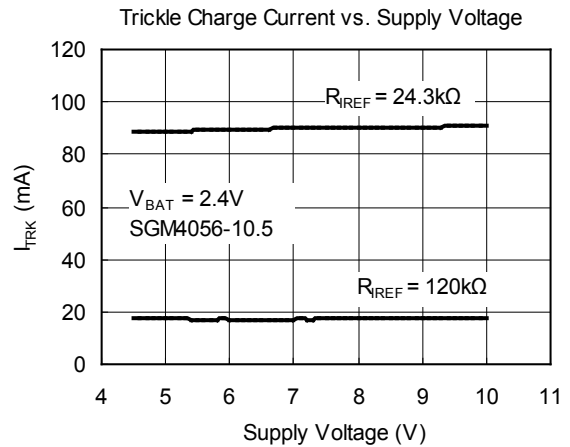
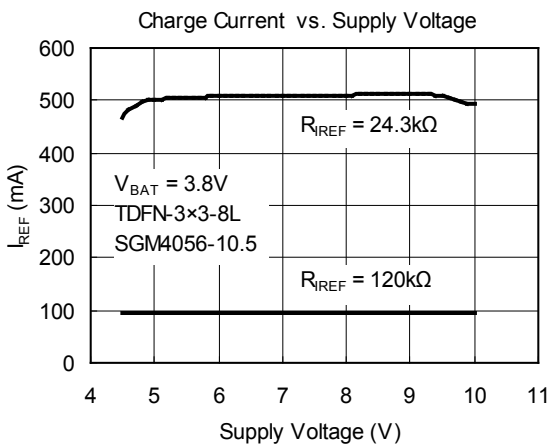
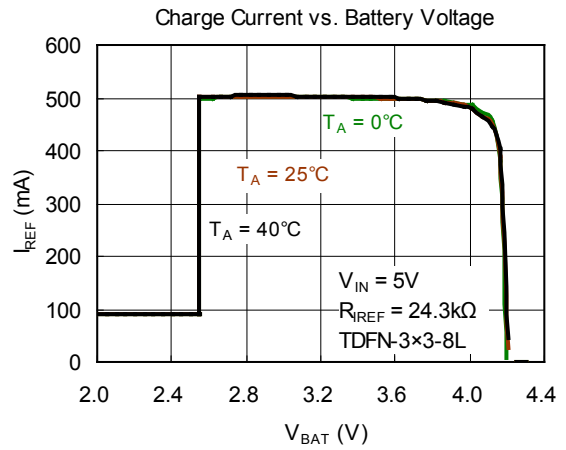
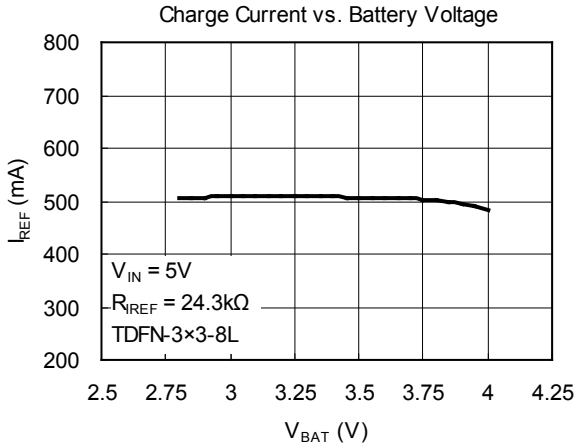

TYPICAL PERFORMANCE CHARACTERISTICS (continued)

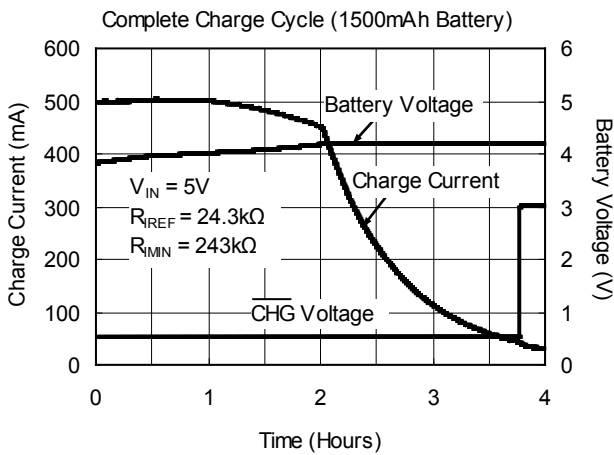
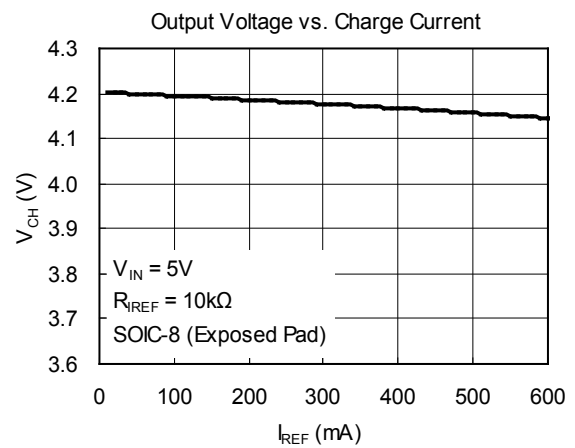
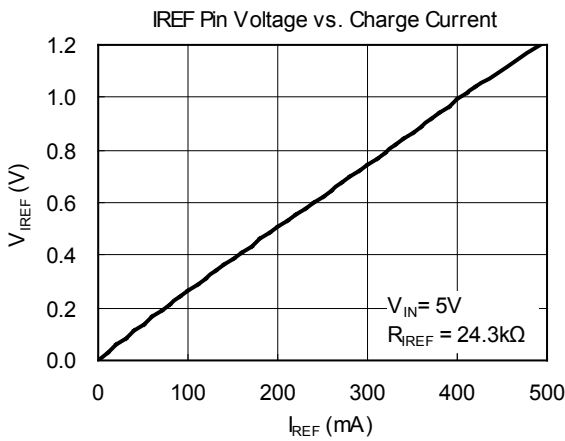
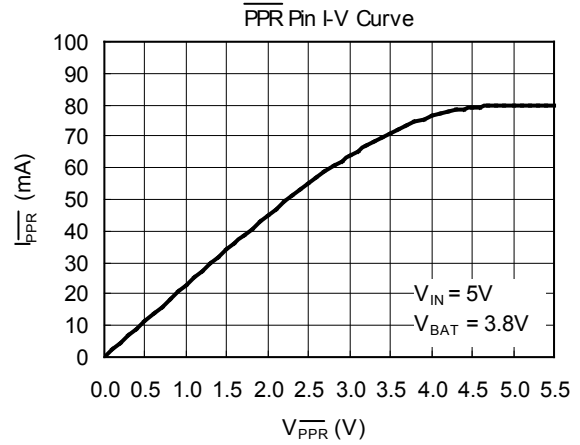
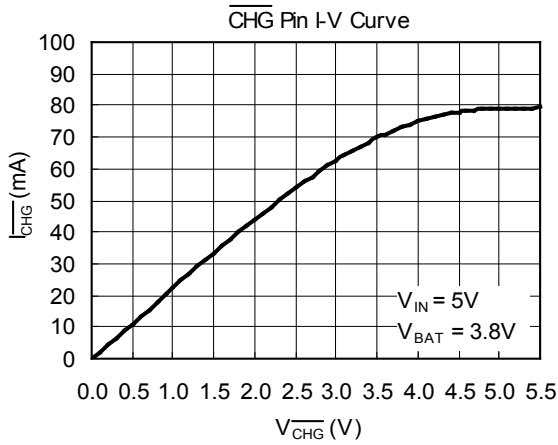

TYPICAL PERFORMANCE CHARACTERISTICS (continued)

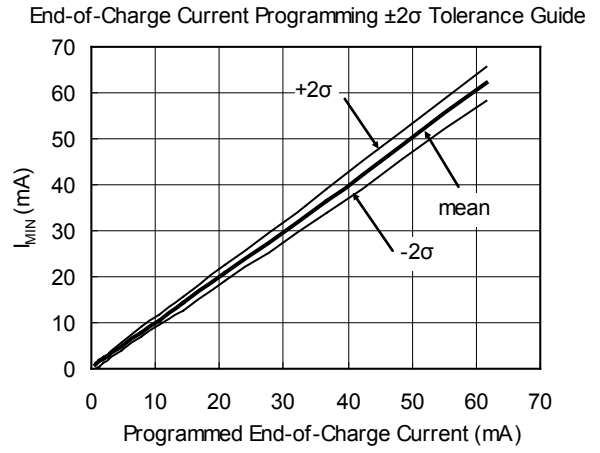
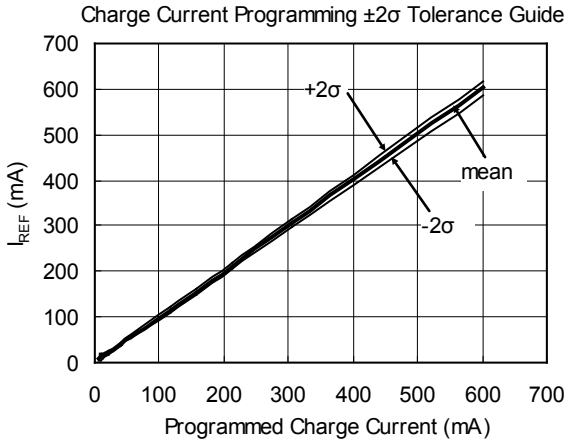

TYPICAL APPLICATION CIRCUITS

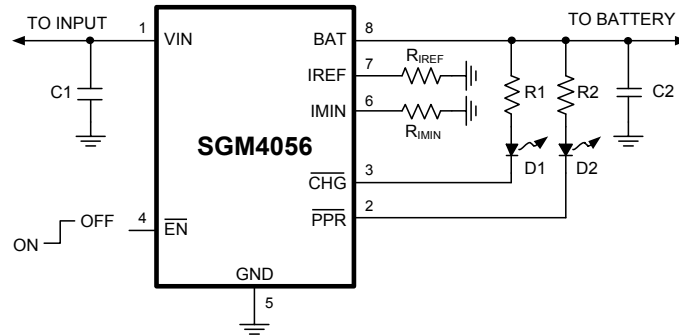

Figure 1. Typical Application Circuit Interfacing to Indication LEDs

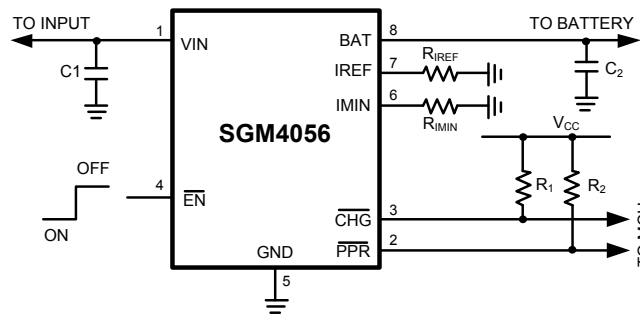

Figure 2. Typical Application Circuit with the Indication Signals Interfacing to an MCU

COMPONENT DESCRIPTION FOR FIGURE 1

PART	DESCRIPTION
C ₁	1μF X5R ceramic cap
C ₂	1μF X5R ceramic cap
R _{IREF}	24.3kΩ, 1%, for 500mA charge current
R _{IMIN}	243kΩ, 1%, for 40mA EOC current
R ₁ , R ₂	300Ω, 5%
D ₁ , D ₂	LEDs for indication

COMPONENT DESCRIPTION FOR FIGURE 2

PART	DESCRIPTION
C ₁	1μF X5R ceramic cap
C ₂	1μF X5R ceramic cap
R _{IREF}	24.3kΩ, 1%, for 500mA charge current
R _{IMIN}	243kΩ, 1%, for 40mA EOC current
R ₁ , R ₂	100kΩ, 5%

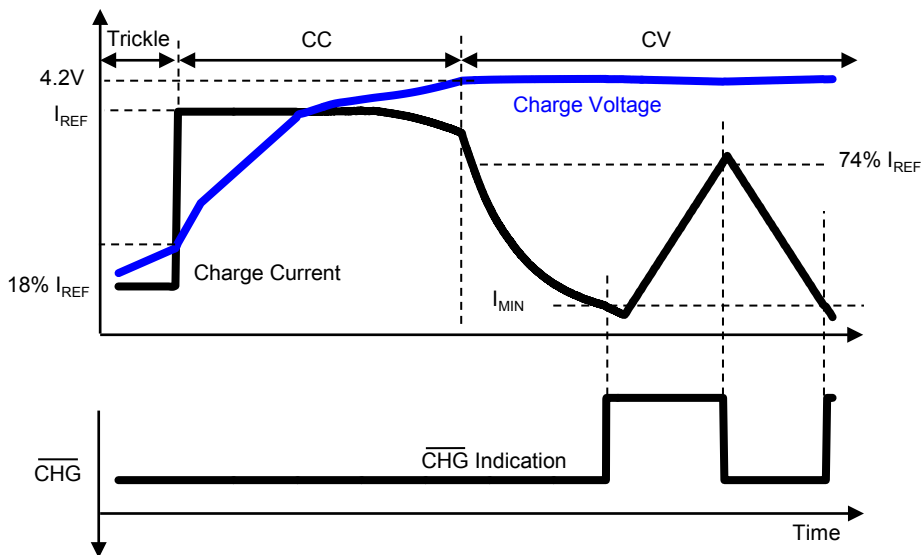

Figure 3. Typical Charge Profile

OPERATION

The SGM4056 charges a Li-Ion battery using a CC/CV profile. The constant current I_{REF} is set with the external resistor R_{IREF} (see Figure 1) and the constant voltage is fixed at 4.2V. If the battery voltage is below a typical 2.55V trickle charge threshold, the SGM4056 charges the battery with a trickle current of 18% of I_{REF} until the battery voltage rises above the trickle charge threshold. Fast charge CC mode is maintained at the rate determined by programming I_{REF} until the cell voltage rises to 4.2V. When the battery voltage reaches 4.2V, the charger enters a CV mode and regulates the battery voltage at 4.2V to fully charge the battery without the risk of over charge. Upon reaching an end-of-charge (EOC) current, the charger indicates the charge completion with the \overline{CHG} pin, but the charger continues to output the 4.2V voltage. Figure 3 shows the typical charge waveforms after the power is on.

The EOC current level I_{MIN} is programmable with the external resistor R_{IMIN} (see Figure 1). The \overline{CHG} pin turns to low when the trickle charge starts and rises to high impedance at the EOC. After the EOC is reached, the charge current has to rise to typically 74% I_{REF} for the \overline{CHG} pin to turn on again, as shown in Figure 3. The current surge after EOC can be caused by a load connected to the battery.

A thermal foldback function reduces the charge current anytime when the die temperature reaches typically 115°C. This function guarantees safe operation when the printed circuit board (PCB) is not capable of dissipating the heat generated by the linear charger. The SGM4056 accepts an input voltage up to 26.5V but disables charging when the input voltage exceeds the OVP threshold, typically 6.8V for SGM4056-6.8 and 10.5V for SGM4056-10.5, to protect against unqualified or faulty AC adapters.

\overline{PPR} Indication

The \overline{PPR} pin is an open-drain output to indicate the presence of the AC adapter. Whenever the input voltage is higher than the POR threshold, the \overline{PPR} pin turns on the internal open-drain MOSFET to indicate a logic low signal, independent on the \overline{EN} pin input. When the internal open-drain FET is turned off, the \overline{PPR} pin leaks less than 20 μ A current. When turned on, the \overline{PPR} pin is able to sink at least 15mA current under all operating conditions. The \overline{PPR} pin can be used to

drive an LED (see Figure 1) or to interface with a micro-processor.

Power Good Range

The power good range is defined by the following three conditions:

1. $V_{IN} > V_{POR}$
2. $V_{IN} - V_{BAT} > V_{OS}$
3. $V_{IN} < V_{OVP}$

where the V_{OS} is the offset voltage for the input and output voltage comparator, discussed shortly, and the V_{OVP} is the over-voltage protection threshold given in the Electrical Characteristics table. All V_{POR} , V_{OS} , and V_{OVP} have hysteresis, as given in the Electrical Characteristics table. The charger will not charge the battery if the input voltage is not in the power good range.

Input and Output Comparator

The charger will not be enabled unless the input voltage is higher than the battery voltage by an offset voltage V_{OS} . The purpose of this comparator is to ensure that the charger is turned off when the input power is removed from the charger. Without this comparator, it is possible that the charger will fail to power down when the input is removed and the current can leak through the PFET pass element to continue biasing the POR and the Pre-Regulator blocks.

Dropout Voltage

The constant current may not be maintained due to the $R_{DS(ON)}$ limit at a low input voltage. The worst case $R_{DS(ON)}$ is at the maximum allowable operating temperature.

\overline{CHG} Indication

The \overline{CHG} is an open-drain output capable of sinking at least 15mA current when the charger starts to charge, and turns off when the EOC current is reached. The \overline{CHG} signal is interfaced either with a microprocessor GPIO or an LED for indication.

OPERATION (continued)

$\overline{\text{EN}}$ Input

$\overline{\text{EN}}$ is an active-low logic input to enable the charger. Drive the $\overline{\text{EN}}$ pin to low or leave it floating to enable the charger. This pin has a 200k Ω internal pull-down resistor so when left floating, the input is equivalent to logic low. Drive this pin to high to disable the charger. The threshold for high is given in the Electrical Characteristics table.

IREF Pin

The IREF pin has the two functions as described in the Pin Description section. When setting the fast charge current, the charge current is guaranteed to have 12% accuracy with the charge current set at 500mA. When monitoring the charge current, the accuracy of the IREF pin voltage vs. the actual charge current has the same accuracy as the gain from the IREF pin current to the actual charge current.

Operation without the Battery

The SGM4056 relies on a battery for stability and works under LDO mode if the battery is not connected. With a battery, the charger will be stable with an output ceramic decoupling capacitor in the range of 1 μF to 200 μF . In LDO mode, its stability depends on load current, C_{OUT} , etc. The maximum load current is limited by the dropout voltage, the programmed I_{REF} and the thermal foldback.

Thermal Foldback

The thermal foldback function starts to reduce the charge current when the internal temperature reaches a typical value of +115 $^{\circ}\text{C}$.

APPLICATION INFORMATION

Input Capacitor Selection

The input capacitor is required to suppress the power supply transient response during transitions. Mainly this capacitor is selected to avoid oscillation during the start up when the input supply is passing the POR threshold and the VIN-BAT comparator offset voltage. When the battery voltage is above the POR threshold, the $V_{IN} - V_{BAT}$ offset voltage dominates the hysteresis value. Typically, a 1µF X5R ceramic capacitor should be sufficient to suppress the power supply noise.

Output Capacitor Selection

The criterion for selecting the output capacitor is to maintain the stability of the charger as well as to bypass any transient load current. The minimum capacitance is a 1µF X5R ceramic capacitor. The actual capacitance connected to the output is dependent on the actual application requirement.

Layout Guidance

The SGM4056 uses thermally-enhanced TDFN and SOIC packages that have an exposed thermal pad at the bottom side of the packages. The layout should connect as much as possible to copper on the exposed pad. Typically the component layer is more effective in dissipating heat. The thermal impedance can be further reduced by using other layers of copper connecting to the exposed pad through a thermal via array. Each thermal via is recommended to have 0.3mm diameter and 1mm distance from other thermal vias.

Input Power Sources

The input power source is typically a well-regulated wall cube with 1-meter length wire or a USB port. The SGM4056 can withstand up to 26.5V on the input without damaging the IC. If the input voltage is higher than typically 6.8V (SGM4056-6.8) or 10.5V (SGM4056-10.5), the charger stops charging.

REVISION HISTORY

NOTE: Page numbers for previous revisions may differ from page numbers in the current version.

MAY 2017 – REV.A.2 to REV.A.3

Changed Absolute Maximum Ratings section.....	2
---	---

MAY 2015 – REV.A.1 to REV.A.2

Changed Pin Description section.....	3
Added Typical Performance Characteristics section	10

NOVEMBER 2014 – REV.A to REV.A.1

Changed Electrical Characteristics section	4
--	---

Changes from Original (JANUARY 2013) to REV.A

Changed from product preview to production data.....	All
--	-----

PACKAGE OUTLINE DIMENSIONS

TDFN-3x3-8L

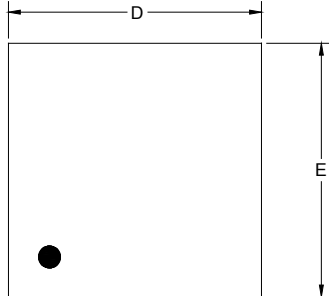

TOP VIEW

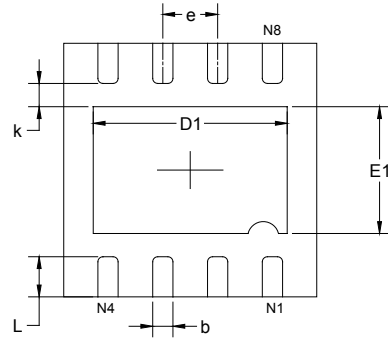

BOTTOM VIEW

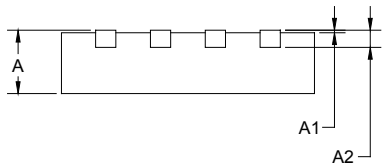

SIDE VIEW

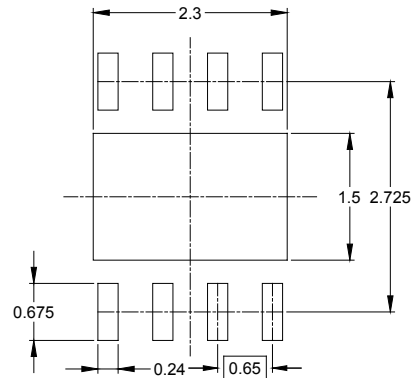

RECOMMENDED LAND PATTERN (Unit: mm)

Symbol	Dimensions In Millimeters		Dimensions In Inches	
	MIN	MAX	MIN	MAX
A	0.700	0.800	0.028	0.031
A1	0.000	0.050	0.000	0.002
A2	0.203 REF		0.008 REF	
D	2.900	3.100	0.114	0.122
D1	2.200	2.400	0.087	0.094
E	2.900	3.100	0.114	0.122
E1	1.400	1.600	0.055	0.063
k	0.200 MIN		0.008 MIN	
b	0.180	0.300	0.007	0.012
e	0.650 TYP		0.026 TYP	
L	0.375	0.575	0.015	0.023

PACKAGE OUTLINE DIMENSIONS

TDFN-2x3-8L

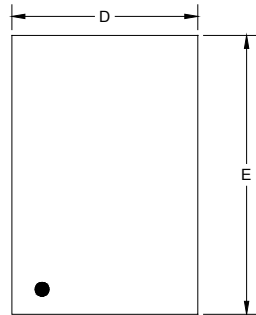

TOP VIEW

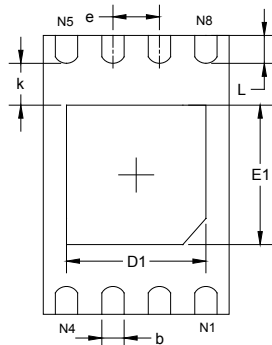

BOTTOM VIEW

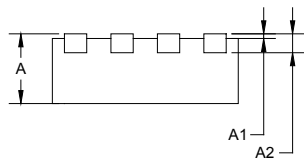

SIDE VIEW

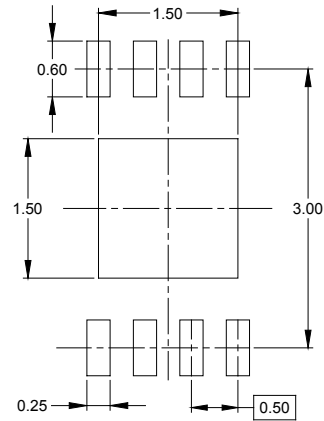

RECOMMENDED LAND PATTERN (Unit: mm)

Symbol	Dimensions In Millimeters		Dimensions In Inches	
	MIN	MAX	MIN	MAX
A	0.700	0.800	0.028	0.031
A1	0.000	0.050	0.000	0.002
A2	0.203 REF		0.008 REF	
D	1.924	2.076	0.076	0.082
D1	1.400	1.600	0.055	0.063
E	2.924	3.076	0.115	0.121
E1	1.400	1.600	0.055	0.063
k	0.200 MIN		0.008 MIN	
b	0.200	0.300	0.008	0.012
e	0.500 TYP		0.020 TYP	
L	0.224	0.376	0.009	0.015

PACKAGE OUTLINE DIMENSIONS

TDFN-2x2-8L

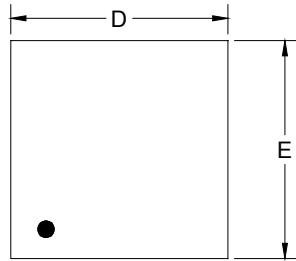

TOP VIEW

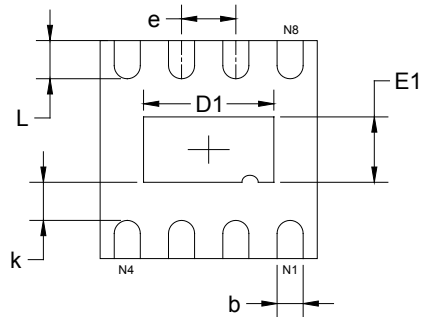

BOTTOM VIEW

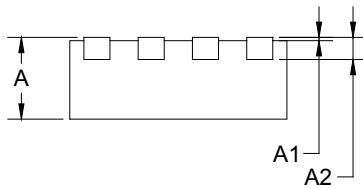

SIDE VIEW

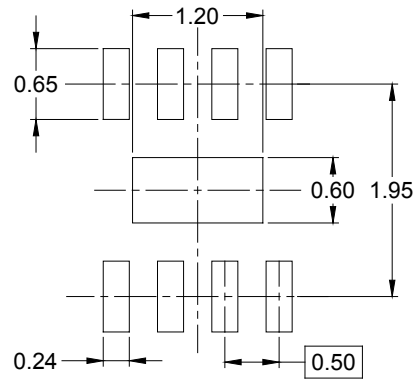

RECOMMENDED LAND PATTERN (Unit: mm)

Symbol	Dimensions In Millimeters		Dimensions In Inches	
	MIN	MAX	MIN	MAX
A	0.700	0.800	0.028	0.031
A1	0.000	0.050	0.000	0.002
A2	0.203 REF		0.008 REF	
D	1.900	2.100	0.075	0.083
D1	1.100	1.300	0.043	0.051
E	1.900	2.100	0.075	0.083
E1	0.500	0.700	0.020	0.028
k	0.200 MIN		0.008 MIN	
b	0.180	0.300	0.007	0.012
e	0.500 TYP		0.020 TYP	
L	0.250	0.450	0.010	0.018

PACKAGE OUTLINE DIMENSIONS

SOIC-8 (Exposed Pad)

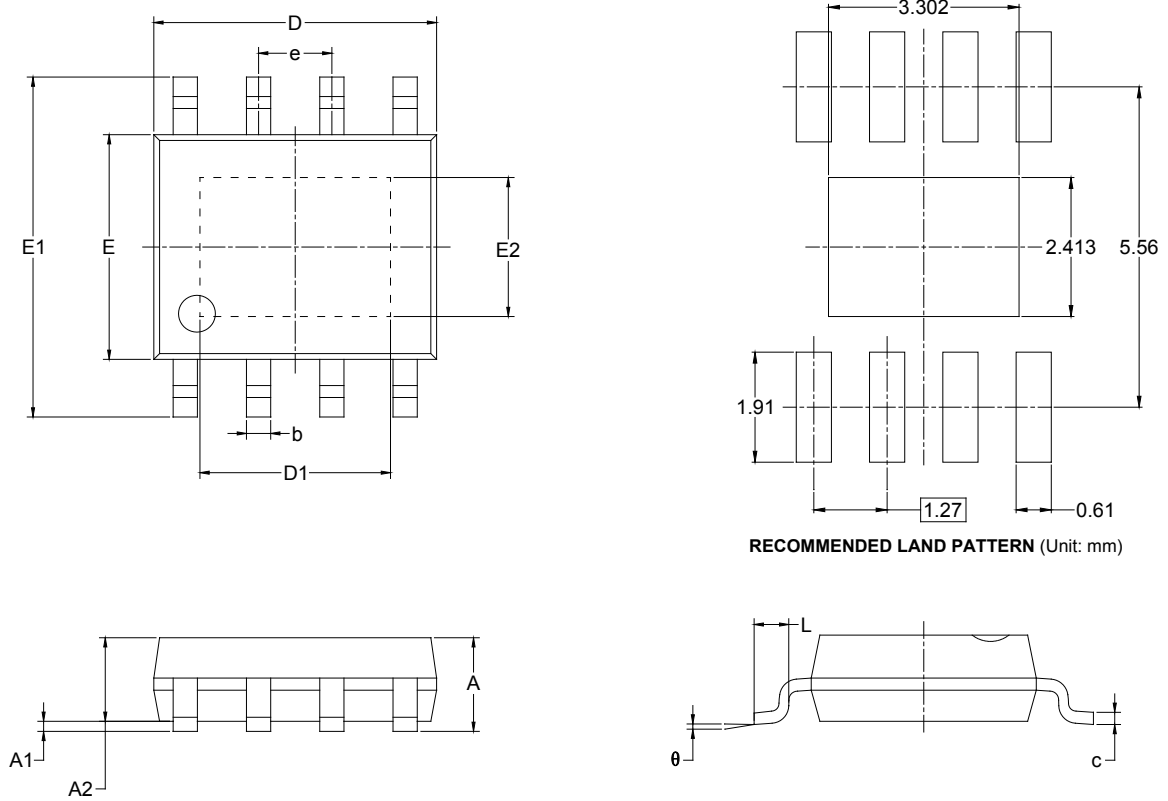

RECOMMENDED LAND PATTERN (Unit: mm)

Symbol	Dimensions In Millimeters		Dimensions In Inches	
	MIN	MAX	MIN	MAX
A		1.700		0.067
A1	0.000	0.100	0.000	0.004
A2	1.350	1.550	0.053	0.061
b	0.330	0.510	0.013	0.020
c	0.170	0.250	0.007	0.010
D	4.700	5.100	0.185	0.201
D1	3.202	3.402	0.126	0.134
E	3.800	4.000	0.150	0.157
E1	5.800	6.200	0.228	0.244
E2	2.313	2.513	0.091	0.099
e	1.27 BSC		0.050 BSC	
L	0.400	1.270	0.016	0.050
θ	0°	8°	0°	8°

PACKAGE INFORMATION

TAPE AND REEL INFORMATION

REEL DIMENSIONS



TAPE DIMENSIONS



NOTE: The picture is only for reference. Please make the object as the standard.

KEY PARAMETER LIST OF TAPE AND REEL

Package Type	Reel Diameter	Reel Width W1 (mm)	A0 (mm)	B0 (mm)	K0 (mm)	P0 (mm)	P1 (mm)	P2 (mm)	W (mm)	Pin1 Quadrant
TDFN-3×3-8L	13"	12.4	3.35	3.35	1.13	4.0	8.0	2.0	12.0	Q1
TDFN-2×3-8L	7"	9.5	2.30	3.30	1.10	4.0	4.0	2.0	8.0	Q2
TDFN-2×2-8L	7"	9.5	2.30	2.30	1.10	4.0	4.0	2.0	8.0	Q1
SOIC-8 (Exposed Pad)	13"	12.4	6.40	5.40	2.10	4.0	8.0	2.0	12.0	Q1

D00001

CARTON BOX DIMENSIONS



NOTE: The picture is only for reference. Please make the object as the standard.

KEY PARAMETER LIST OF CARTON BOX

Reel Type	Length (mm)	Width (mm)	Height (mm)	Pizza/Carton
7" (Option)	368	227	224	8
7"	442	410	224	18
13"	386	280	370	5

DD0002