

# PE606BA

## N-Channel Enhancement Mode MOSFET

### PRODUCT SUMMARY

$V_{(BR)DSS}$	$R_{DS(ON)}$	$I_D^3$
30V	18m $\Omega$ @ $V_{GS} = 10V$	23A



PDFN 3X3P

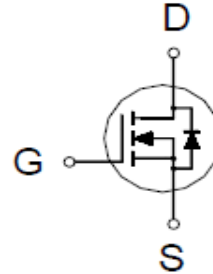

### ABSOLUTE MAXIMUM RATINGS ( $T_A = 25\text{ }^\circ\text{C}$ Unless Otherwise Noted)

PARAMETERS/TEST CONDITIONS		SYMBOL	LIMITS	UNITS
Drain-Source Voltage		$V_{DS}$	30	V
Gate-Source Voltage		$V_{GS}$	$\pm 20$	V
Continuous Drain Current <sup>3</sup>	$T_C = 25\text{ }^\circ\text{C}$	$I_D$	23	A
	$T_C = 100\text{ }^\circ\text{C}$		15	
	$T_A = 25\text{ }^\circ\text{C}$		10.6	
	$T_A = 70\text{ }^\circ\text{C}$		8.5	
Pulsed Drain Current <sup>1</sup>		$I_{DM}$	60	
Avalanche Current		$I_{AS}$	12.6	
Avalanche Energy	$L = 0.1\text{mH}$	$E_{AS}$	7.9	mJ
Power Dissipation	$T_C = 25\text{ }^\circ\text{C}$	$P_D$	17	W
	$T_C = 100\text{ }^\circ\text{C}$		7	
Power Dissipation <sup>4</sup>	$T_A = 25\text{ }^\circ\text{C}$		3.5	
	$T_A = 70\text{ }^\circ\text{C}$		2.2	
Operating Junction & Storage Temperature Range		$T_J, T_{stg}$	-55 to 150	$^\circ\text{C}$

### THERMAL RESISTANCE RATINGS

THERMAL RESISTANCE		SYMBOL	TYPICAL	MAXIMUM	UNITS
Junction-to-Ambient <sup>2</sup>	$t \leq 10\text{s}$	$R_{\theta JA}$		35	$^\circ\text{C} / \text{W}$
Junction-to-Ambient <sup>2</sup>	Steady-State	$R_{\theta JA}$		70	
Junction-to-Case	Steady-State	$R_{\theta JC}$		7	

<sup>1</sup>Pulse width limited by maximum junction temperature.

<sup>2</sup>The value of  $R_{\theta JA}$  is measured with the device mounted on 1in<sup>2</sup> FR-4 board with 2oz. Copper, in a still air environment with  $T_A = 25\text{ }^\circ\text{C}$ .

<sup>3</sup>Package limitation current is 11A.

<sup>4</sup>The Power dissipation is based on  $R_{\theta JA} t \leq 10\text{s}$  value.

# PE606BA

## N-Channel Enhancement Mode MOSFET

### ELECTRICAL CHARACTERISTICS (T<sub>J</sub> = 25 °C, Unless Otherwise Noted)

PARAMETER	SYMBOL	TEST CONDITIONS	LIMITS			UNITS
			MIN	TYP	MAX	
<b>STATIC</b>						
Drain-Source Breakdown Voltage	V <sub>(BR)DSS</sub>	V <sub>GS</sub> = 0V, I <sub>D</sub> = 250μA	30			V
Gate Threshold Voltage	V <sub>GS(th)</sub>	V <sub>DS</sub> = V <sub>GS</sub> , I <sub>D</sub> = 250μA	1.3	1.75	2.3	
Gate-Body Leakage	I <sub>GSS</sub>	V <sub>DS</sub> = 0V, V <sub>GS</sub> = ±20V			±100	nA
Zero Gate Voltage Drain Current	I <sub>DSS</sub>	V <sub>DS</sub> = 24V, V <sub>GS</sub> = 0V			1	μA
		V <sub>DS</sub> = 20V, V <sub>GS</sub> = 0V, T <sub>J</sub> = 55 °C			10	
Drain-Source On-State Resistance <sup>1</sup>	R <sub>DS(ON)</sub>	V <sub>GS</sub> = 4.5V, I <sub>D</sub> = 6A		19	27	mΩ
		V <sub>GS</sub> = 10V, I <sub>D</sub> = 7A		13	18	
Forward Transconductance <sup>1</sup>	g <sub>fs</sub>	V <sub>DS</sub> = 10V, I <sub>D</sub> = 7A		25		S
<b>DYNAMIC</b>						
Input Capacitance	C <sub>iss</sub>	V <sub>GS</sub> = 0V, V <sub>DS</sub> = 15V, f = 1MHz		333		pF
Output Capacitance	C <sub>oss</sub>			64		
Reverse Transfer Capacitance	C <sub>rss</sub>			43		
Gate Resistance	R <sub>g</sub>	V <sub>GS</sub> = 0V, V <sub>DS</sub> = 0V, f = 1MHz		2		Ω
Total Gate Charge <sup>2</sup>	Q <sub>g(VGS=10V)</sub>	V <sub>DS</sub> = 15V, I <sub>D</sub> = 7A		7.5		nC
	Q <sub>g(VGS=4.5V)</sub>			4.3		
Gate-Source Charge <sup>2</sup>	Q <sub>gs</sub>			1.1		
Gate-Drain Charge <sup>2</sup>	Q <sub>gd</sub>			2.3		
Turn-On Delay Time <sup>2</sup>	t <sub>d(on)</sub>		V <sub>DD</sub> = 15V, I <sub>D</sub> ≅ 7A, V <sub>GEN</sub> = 10V, R <sub>G</sub> = 6Ω		17	
Rise Time <sup>2</sup>	t <sub>r</sub>			17		
Turn-Off Delay Time <sup>2</sup>	t <sub>d(off)</sub>			37		
Fall Time <sup>2</sup>	t <sub>f</sub>			18		
<b>SOURCE-DRAIN DIODE RATINGS AND CHARACTERISTICS (T<sub>J</sub> = 25 °C)</b>						
Continuous Current <sup>3</sup>	I <sub>S</sub>				15	A
Forward Voltage <sup>1</sup>	V <sub>SD</sub>	I <sub>F</sub> = 7A, V <sub>GS</sub> = 0V			1.1	V
Reverse Recovery Time	t <sub>rr</sub>	I <sub>F</sub> = 7A, dI <sub>F</sub> /dt = 100A / μS		8.4		nS
Reverse Recovery Charge	Q <sub>rr</sub>			2.2		nC

<sup>1</sup>Pulse test : Pulse Width ≤ 300 μsec, Duty Cycle ≤ 2%.

<sup>2</sup>Independent of operating temperature.

<sup>3</sup>Package limitation current is 11A.

# PE606BA

## N-Channel Enhancement Mode MOSFET

**Output Characteristics**

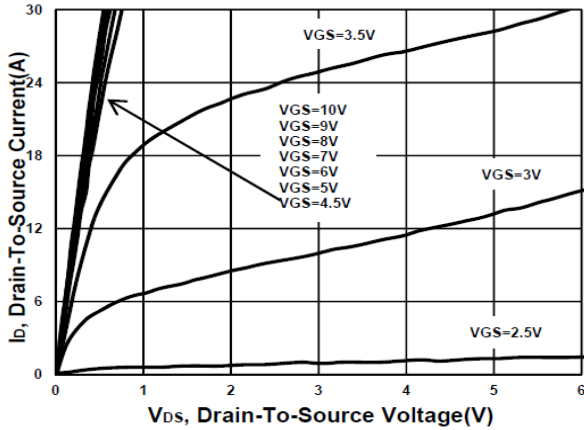

**Transfer Characteristics**

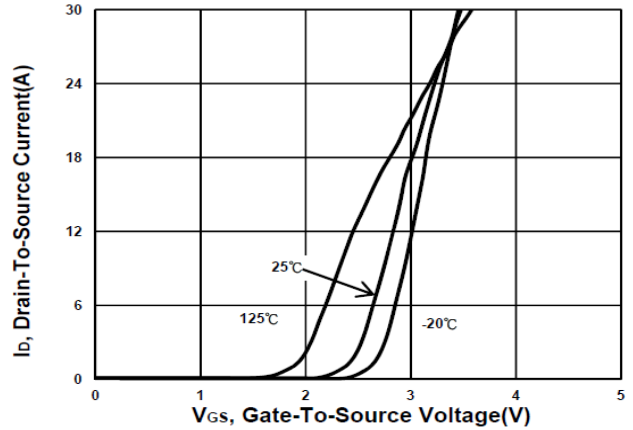

**On-Resistance VS Temperature**

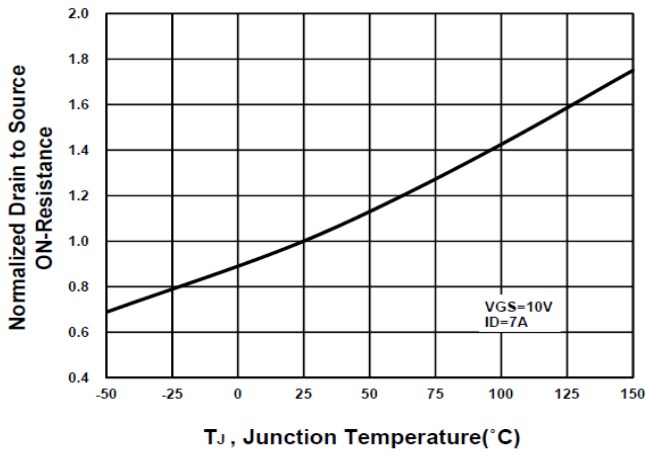

**Capacitance Characteristic**

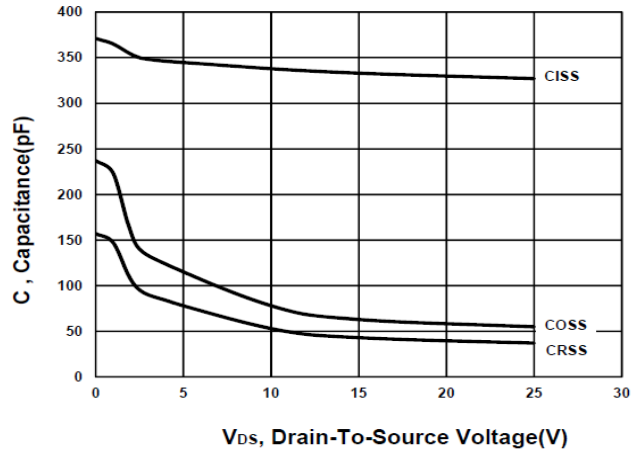

**Gate charge Characteristics**

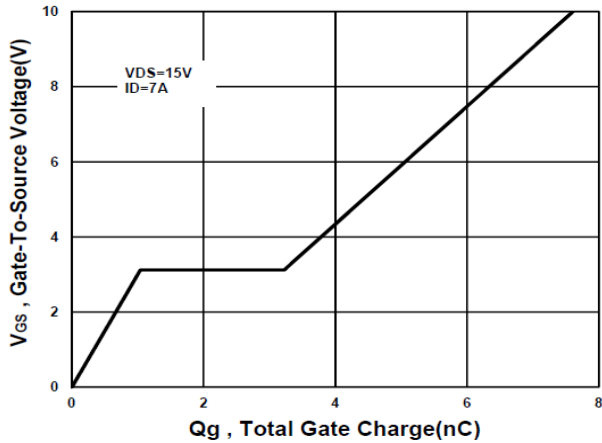

**Source-Drain Diode Forward Voltage**

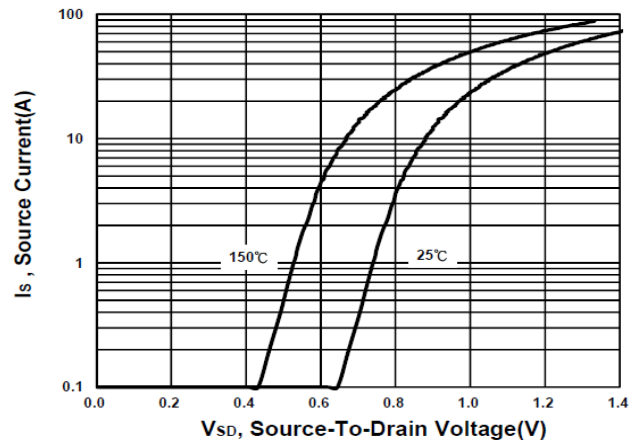

# PE606BA

## N-Channel Enhancement Mode MOSFET

**Safe Operating Area**

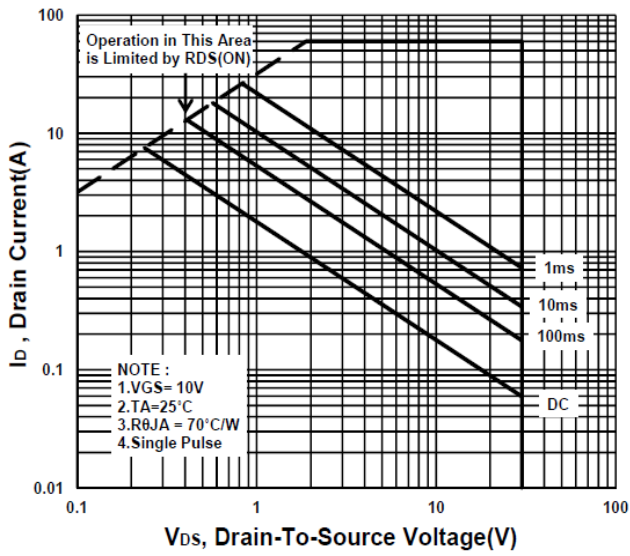

**Single Pulse Maximum Power Dissipation**

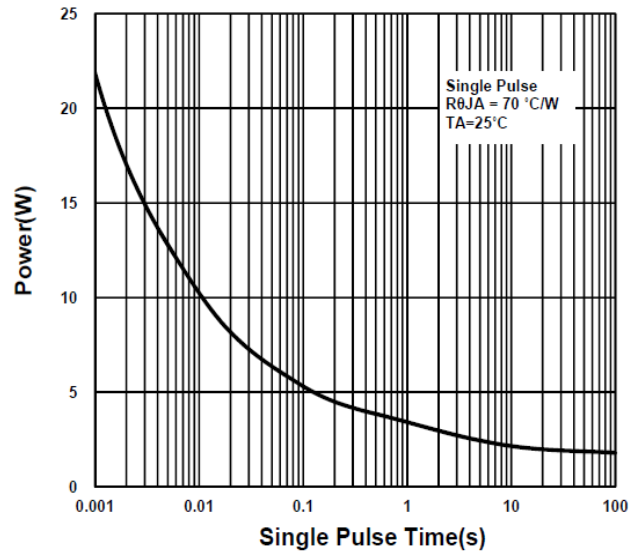

**Transient Thermal Response Curve**

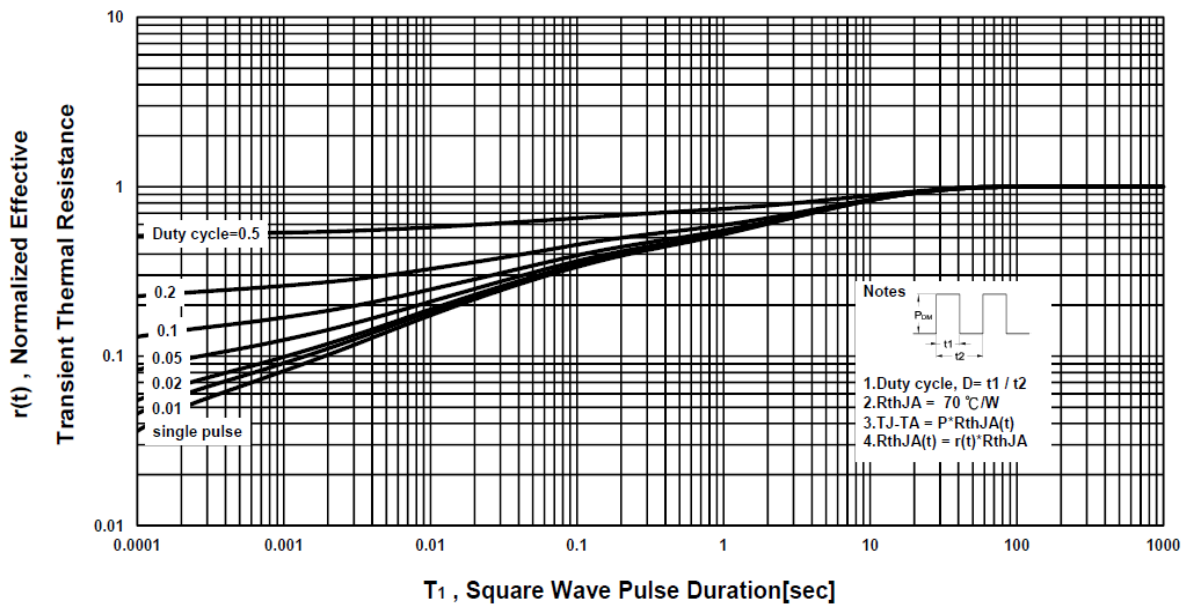

# PE606BA

## N-Channel Enhancement Mode MOSFET

### Package Dimension

### PDFN 3x3P MECHANICAL DATA

Dimension	mm			Dimension	mm		
	Min.	Typ.	Max.		Min.	Typ.	Max.
A	3		3.6	I	0.7		1.12
B	2.88		3.2	J	0.1		0.33
C	2.9		3.2	K	0.6		
D	1.98		2.69	L	0°	10°	12°
E	3		3.6	M	0.14		0.41
F	0		0.455	N	0.6		0.7
G	1.47		2.2	O	0.12		0.36
H	0.15		0.56	P	0		0.2

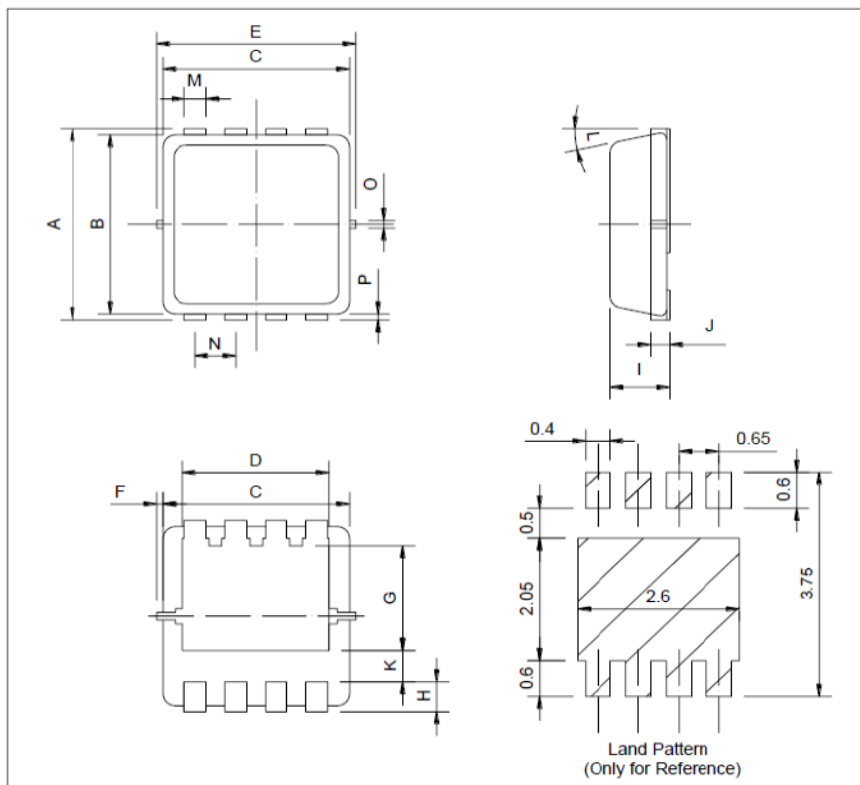

# PE606BA

## N-Channel Enhancement Mode MOSFET

### A. Marking Information(此产品代码为: F2)

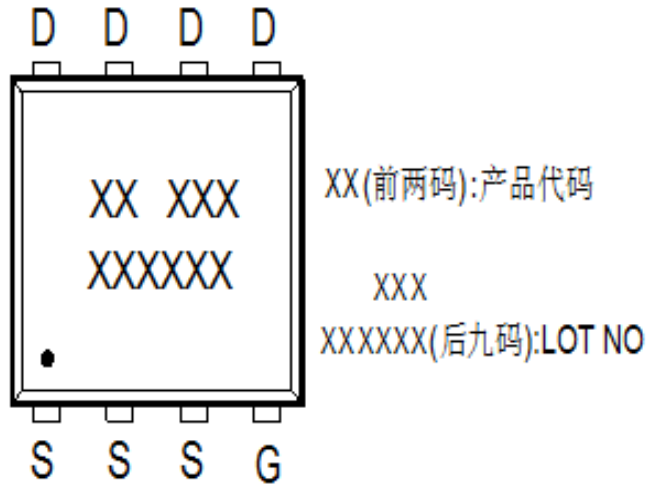

### B. Tape&Reel Information:5000pcs/Reel

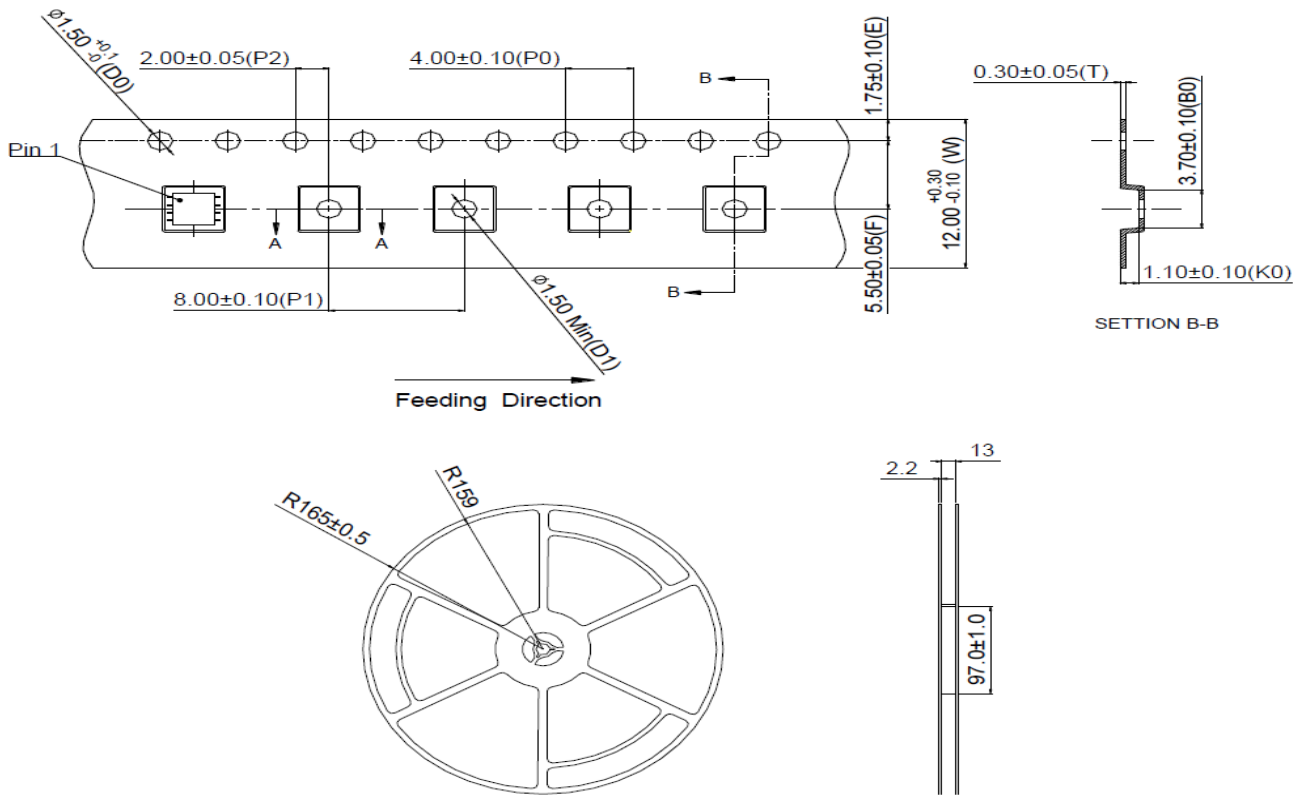

**PE606BA**  
**N-Channel Enhancement Mode MOSFET**

**C. Lot No.&Date Code rule**

1. Lot No.

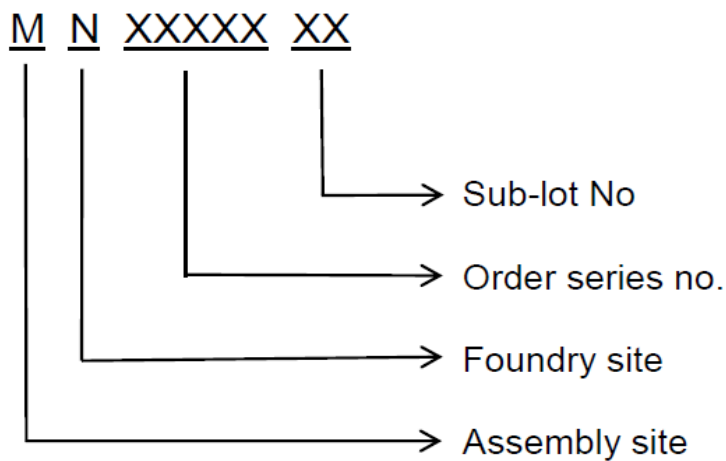

2. Date Code

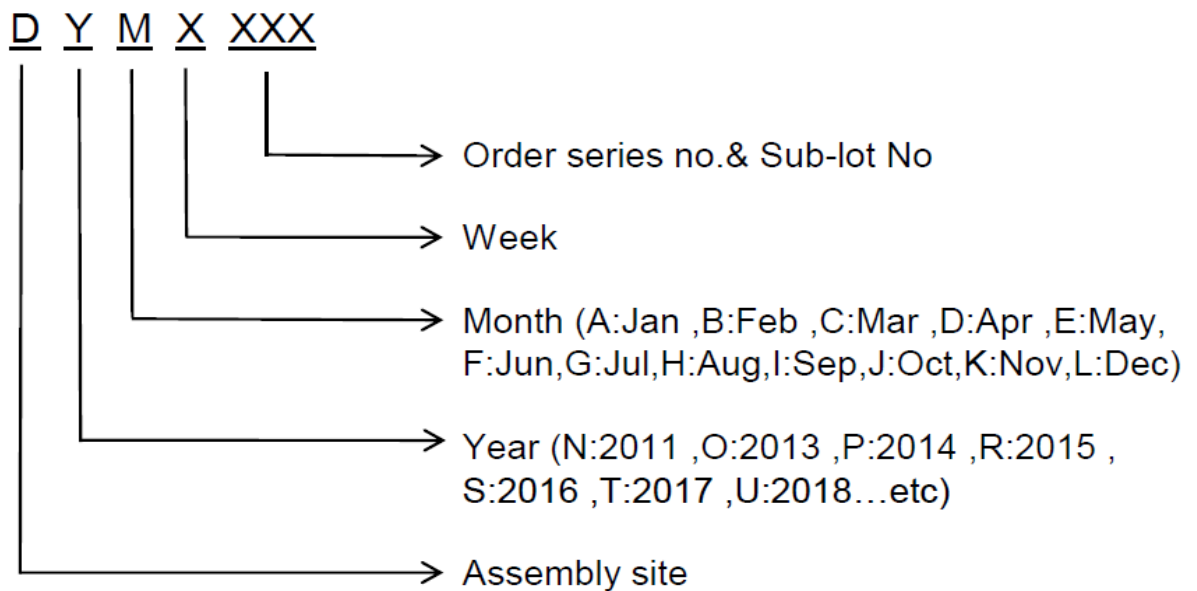



# PE606BA

## N-Channel Enhancement Mode MOSFET

### D.Label rule

标签内容(Label content)



1	Label Size	30 * 90 mm
2	Font style	Times New Roman or Arial (或可区分英文”0”和数字”0”，”G和”Q”的字型即可)
3	Great Power	Height: 4 mm
4	Package	Height: 2 mm
5	Date	Height: 2 mm Shipping date: YYYY/MM/DD, ex. 2008/09/12
6	Device	Height: 3 mm (Max: 16 Digit)
7	Lot	Height: 3 mm (Max: 9 Digit) Sub lot
8	D/C	Height: 3 mm (Max: 7 Digit)
9	QTY	Height: 3 mm (Max: 6 Digit) Thousand mark is no needed
10	Pb Free label	 Diameter: 1 cm bottom color: Green Font color: Black Font style: Arial
11	Halogen Free label	 Diameter: 1 cm bottom color: Green Font color: Black Font style: Arial
12	Scan info	Device / Lot / D/C / QTY , Insert “ / “ between every parts. for example: P3055LDG/G12345601/GGG2301/2000 DPI (Dots per inch): Over 300 dpi Code : Code 128 Height: 6 mm at least