



Spring Contact SCTA_A Series (Standard Type)

Part number	SCTA1A0100
Dimensions (W×D)	1.4×1.4mm
Height in use	0.7 to 1.0mm
Travel	0.5mm
Mounting type	Surface mounting type
Mounting style	Standard mount
Packing system	Taping
Minimum order unit (pcs.)	15,000
Operating temperature range	-30°C to +85°C
Rated current	3A
Contact resistance (Initial)	Connector contacts 40mΩ max.
Stroke Frequency	500 times

Dimensions

Unit:mm

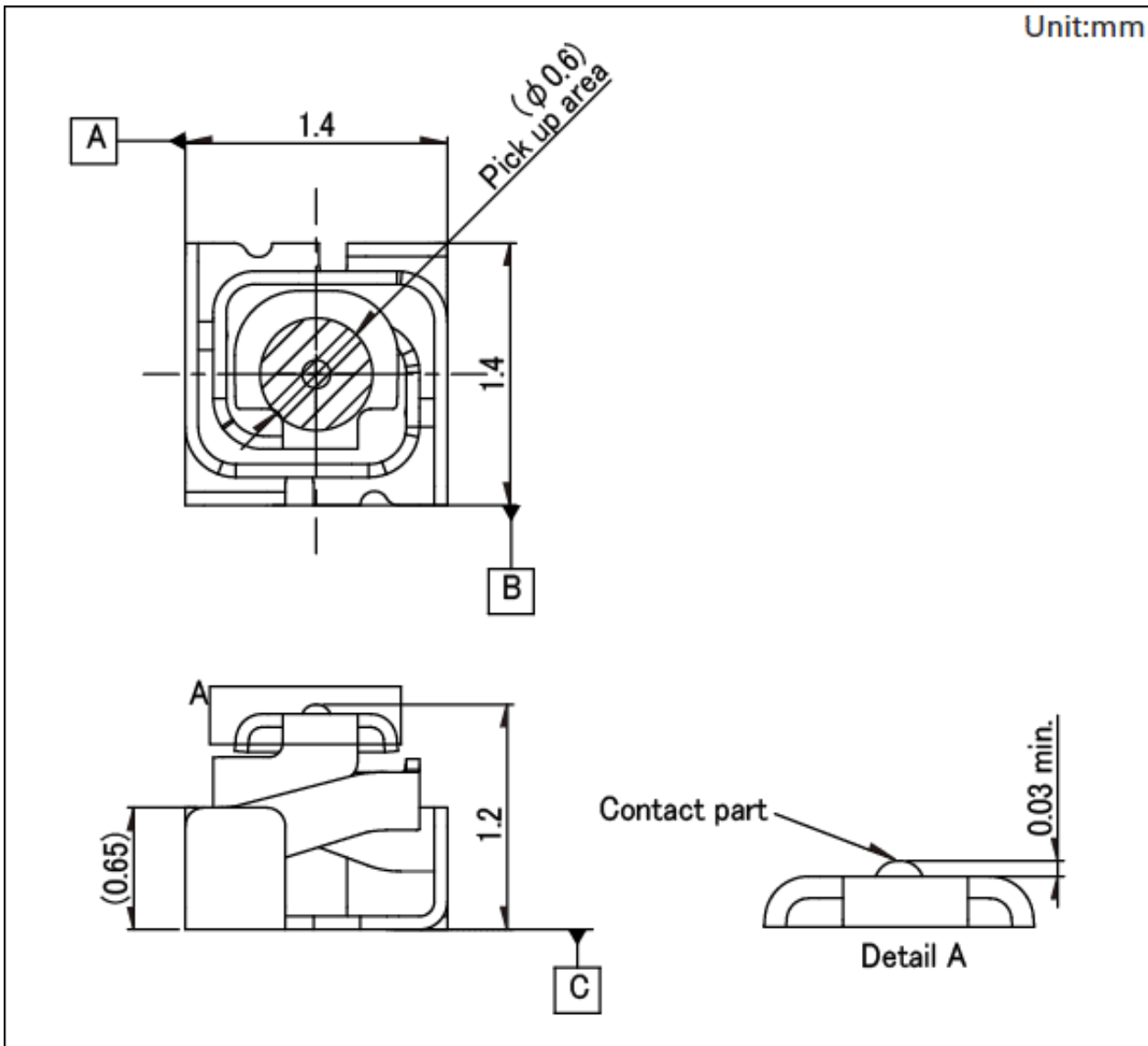

Land Dimensions

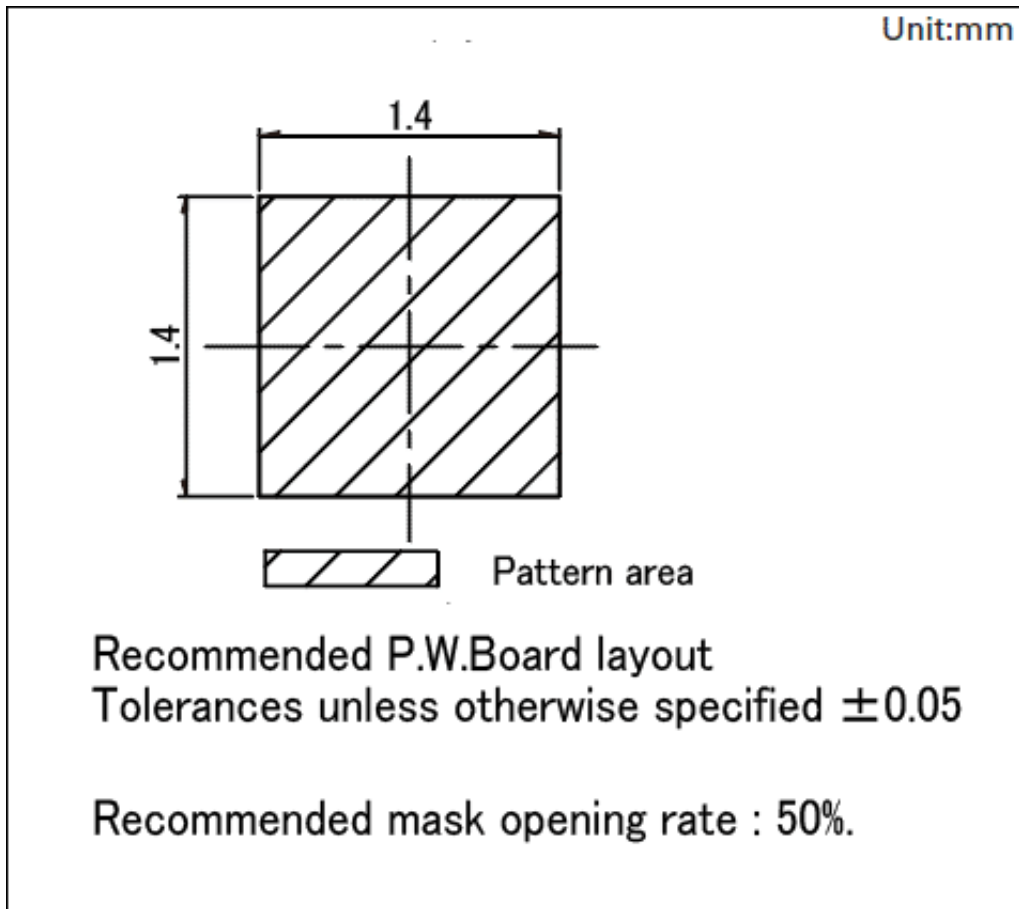

Packing Specifications

Taping

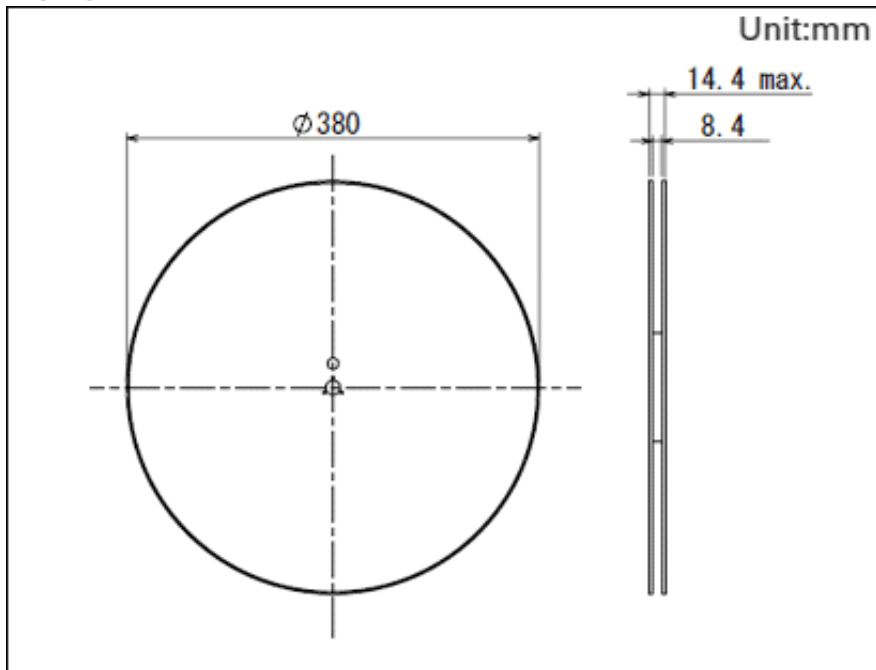

Number of packages (pcs.)	1 reel	15,000
	1 case / Japan	45,000
	1 case / export packing	90,000

Tape width (mm)

8

Export package measurements (mm)

403×403×167

Soldering Conditions

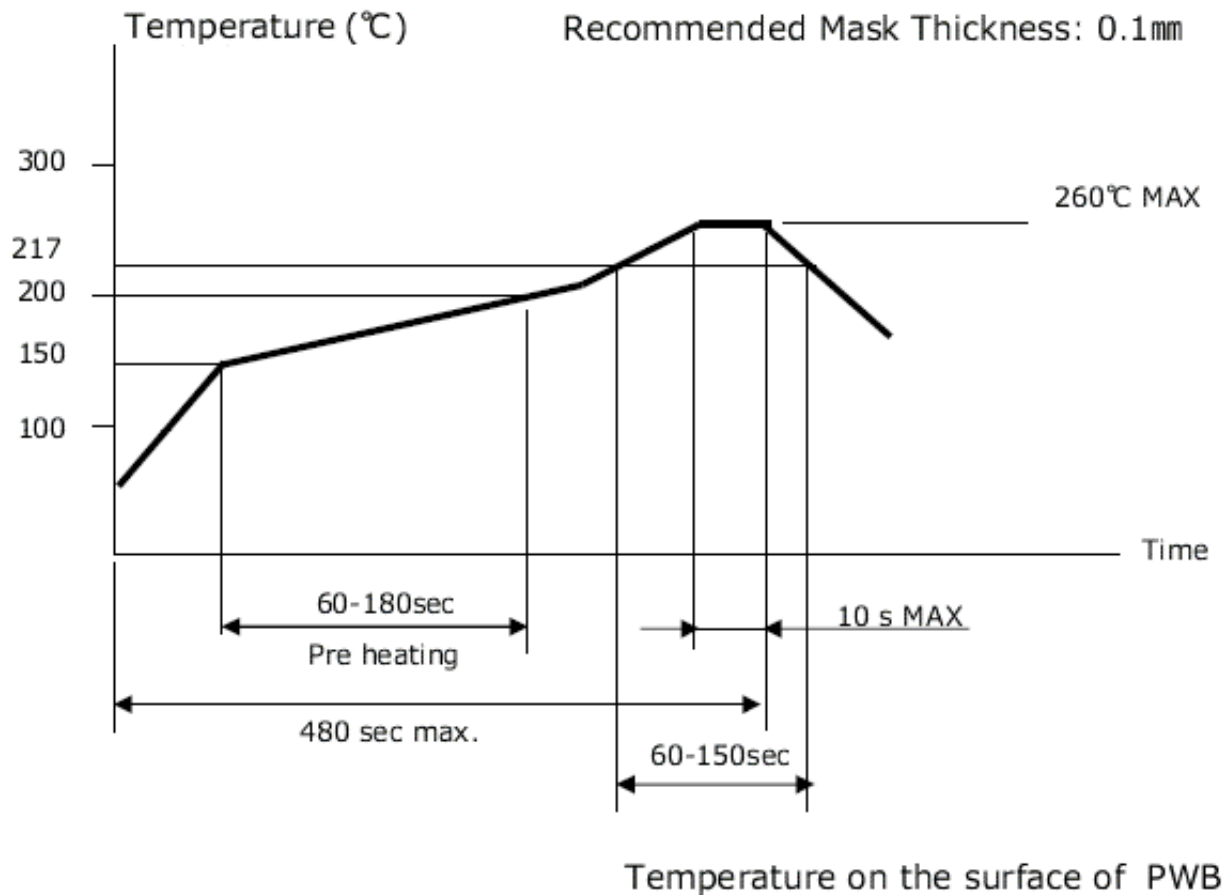

Notes are common to this series/models.

1. This site catalog shows only outline specifications. When using the products, please obtain formal specifications for supply.
2. Please place purchase orders per minimum order unit (integer).