



TAIWAN TONGJIA OPTOELECTRONICS TECHNOLOGY CO., LTD

DONGGUAN TONGJIA OPTOELECTRONICS TECHNOLOGY CO., LTD

承認書

Specification For Approval

Customer: (客戶)

Description: (產品描述)

SMD0805燈珠側發普綠

Part number: (產品型號)

TJ-S2005SW9TGLC7K-A5

Date: (日期)

Approved By: (客戶承認)

| |
|--|
| |
|--|

Prepared By: (我司承認)

| Approval | Check | Design | Sales |
|----------|-------|--------|-------|
| | | | |

核准

審核

製作

業務

Customer Service Hotline: **400-676-8616**

TEL: 0769-8662 5999 0769-8200 2226

E-MAIL : dg@togialed.com

FAX: 0769-8200 2227

WEB: www.togialed.com

Features

2.0mm x 0.5mm SMT LED, 0.96 mm thickness

Low power consumption

Wide view angle

Package: 4000pcs/reel

RoHS Compliant

Applications

Ideal for back light and indicator

Various colors and lens types available

Package outlines

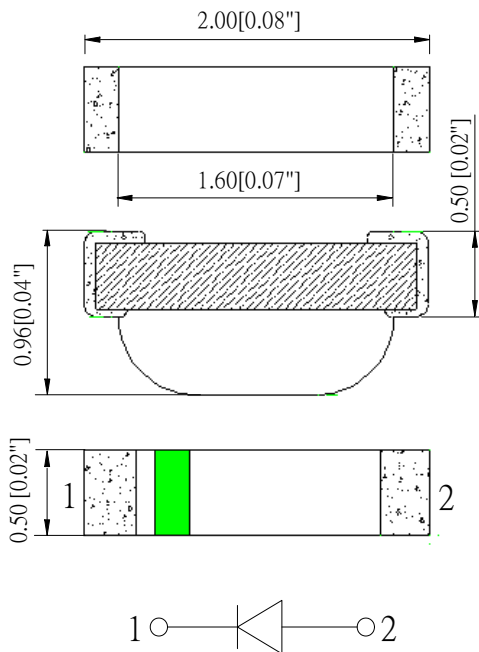

Recommend Pad Layout

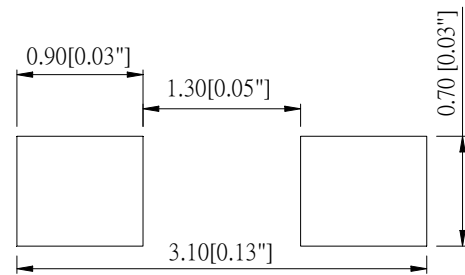

| Part No. | Emitted color | Dice | Lens color |
|----------------------|---------------|---------|-------------------|
| TJ-S2005SW9TGLC7K-A5 | Green | AlGaInP | Water transparent |

Notes:

1. All dimensions are in millimeters (inches);
2. Tolerances are $\pm 0.1\text{mm}$ (0.004inch) unless otherwise noted.

Absolute maximum ratings (TA=25°C)

| Parameter | Symbol | Value | Unit |
|--|--------|----------|------|
| Forward current | If | 30 | mA |
| Reverse voltage | Vr | 5 | V |
| Power dissipation | Pd | 72 | mW |
| Operating temperature | Top | -40 ~+80 | °C |
| Storage temperature | Tstg | -40 ~+85 | °C |
| Peak pulsing current (1/8 duty f=1kHz) | Ifp | 125 | mA |

Electro-optical characteristics (TA=25°C)

| Parameter | Test Condition | Symbol | Value | | | Unit |
|-----------------------------|----------------|------------------|-------|-----|-----|---------|
| | | | Min | Typ | Max | |
| Wavelength at peak emission | If=20mA | λ_p | -- | 573 | -- | nm |
| Spectral half bandwidth | If=20mA | $\Delta \lambda$ | -- | 16 | -- | nm |
| Dominant wavelength | If=20mA | λ_d | 566 | -- | 576 | nm |
| Forward voltage | If=20mA | Vf | 1.8 | -- | 2.4 | V |
| Luminous intensity | If=20mA | Iv | 25 | -- | 80 | mcd |
| Viewing angle at 50% Iv | If=10mA | $2\theta_{1/2}$ | -- | 120 | -- | Deg |
| Reverse current | Vr=5V | Ir | -- | -- | 10 | μA |

Optical characteristic curves

Relative Intensity vs. Wavelength

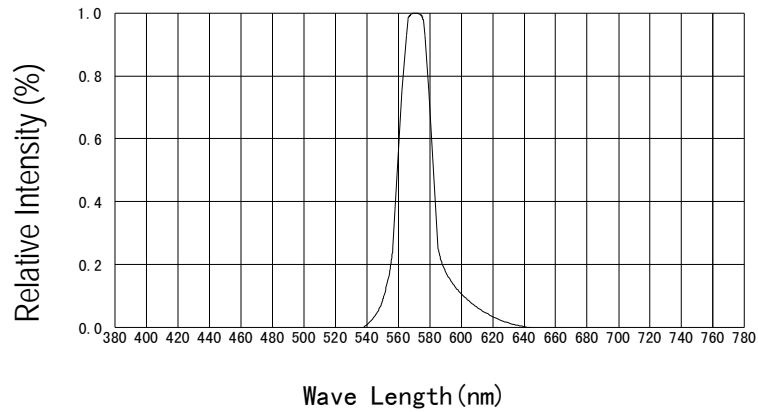

Forward Current vs. Forward Voltage

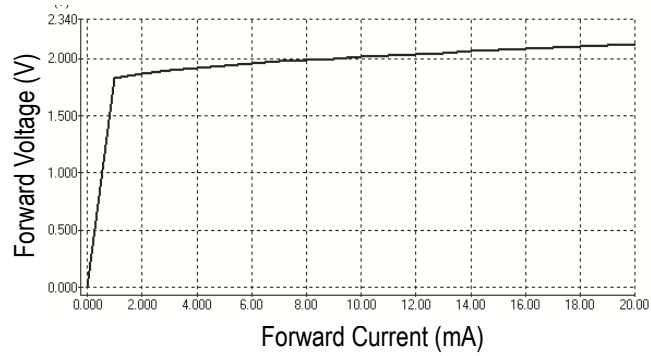

Directive Characteristics



Reflow Profile

■ Reflow Temp/Time

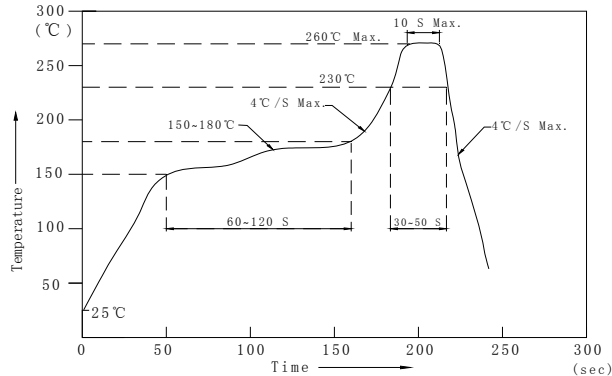

Notes:

1. We recommend the reflow temperature $245^{\circ}\text{C}(\pm 5^{\circ}\text{C})$. the maximum soldering temperature should be limited to 260°C .
2. Don't cause stress to the epoxy resin while it is exposed to high temperature.
3. Number of reflow process shall be 2 times or less.

■ Soldering iron

Basic spec is $\leq 5\text{sec}$ when 260°C . If temperature is higher, time should be shorter ($+10^{\circ}\text{C} \rightarrow -1\text{sec}$). Power dissipation of iron should be smaller than 20W, and temperatures should be controllable. Surface temperature of the device should be under 230°C .

■ Rework

1. Customer must finish rework within 5 sec under 260°C .
2. The head of iron can not touch copper foil
3. Twin-head type is preferred.



- Avoid rubbing or scraping the resin by any object, during high temperature, for example reflow solder etc.

Test circuit and handling precautions

■ Test circuit

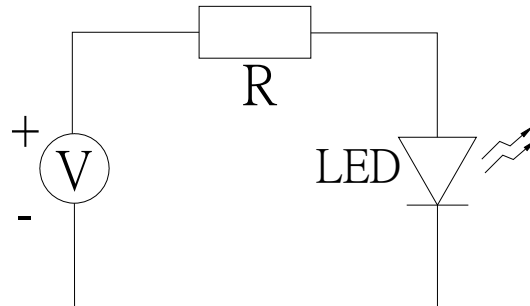

■ Handling precautions

1. Over-current-proof

Customer must apply resistors for protection; otherwise slight voltage shift will cause big current change (Burn out will happen).

2. Storage

2.1 It is recommended to store the products in the following conditions:

Humidity: 60% R.H. Max.

Temperature : 5°C~30°C(41°F~86°F)

2.2 Shelf life in sealed bag: 12 month at <5°C~30°C and <30% R.H. after the package is Opened, the products should be used within a week or they should be keeping to stored at ≤ 20 R.H. with zip-lock sealed.

3. Baking

It is recommended to baking before soldering when the pack is unsealed after 72hrs. The Conditions are as followings:

3.1 $60 \pm 3^\circ\text{C}$ x(12~24hrs) and <5%RH, taped reel type

3.2 $100 \pm 3^\circ\text{C}$ x(45min~1hr), bulk type

3.3 $130 \pm 3^\circ\text{C}$ x(15~30min), bulk type

Test items and results of reliability

| Type | Test Item | Test Conditions | Note | Number of Damaged |
|------------------------|------------------------------|-----------------------------------|-----------|-------------------|
| Environmental Sequence | Temperature Cycle | -20°C 30min ↑ ↓ 80°C 30min | 100 cycle | 0/22 |
| | Thermal Shock | -20°C 15min ↑ ↓ 80°C 15min | 100 cycle | 0/22 |
| | High Humidity Heat Cycle | 30°C ↔ 65°C 90%RH 24hrs/1cycle | 10 cycle | 0/22 |
| | High Temperature Storage | Ta=80°C | 1000 hrs | 0/22 |
| | Humidity Heat Storage | Ta=60°C RH=90% | 1000 hrs | 0/22 |
| | Low Temperature Storage | Ta=-30°C | 1000 hrs | 0/22 |
| Operation Sequence | Life Test | Ta=25°C IF=20mA | 1000 hrs | 0/22 |
| | High Humidity Heat Life Test | 60°C RH=90% IF=10mA | 500 hrs | 0/22 |
| | Low Temperature Life Test | Ta=-20°C IF=20mA | 1000 hrs | 0/22 |

2005 Series SMD Chip LED Lamps Packaging Specifications

- Feeding Direction

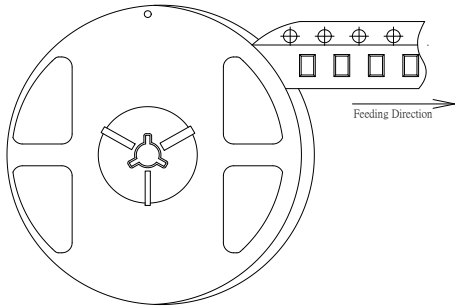

- Dimensions of Reel (Unit: mm)

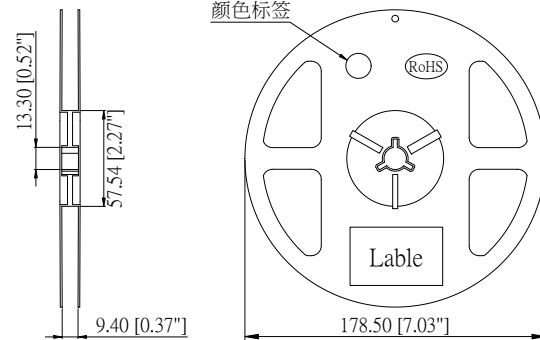

- Dimensions of Tape (Unit: mm)

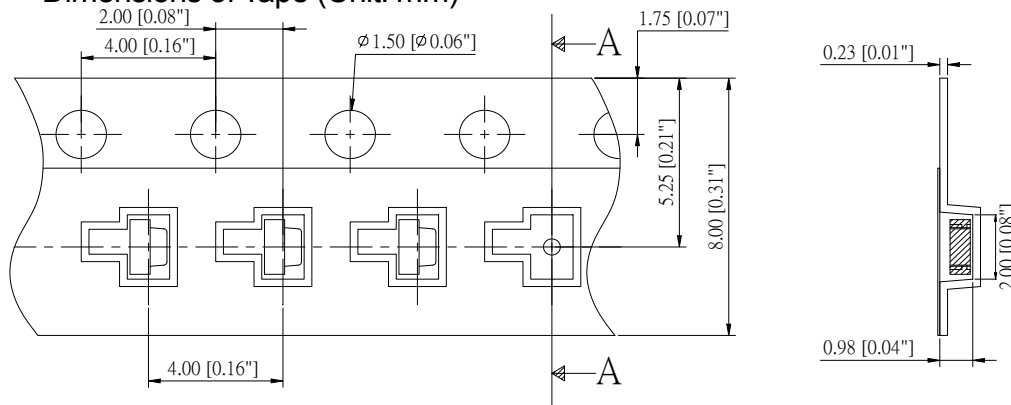

- Arrangement of Tape

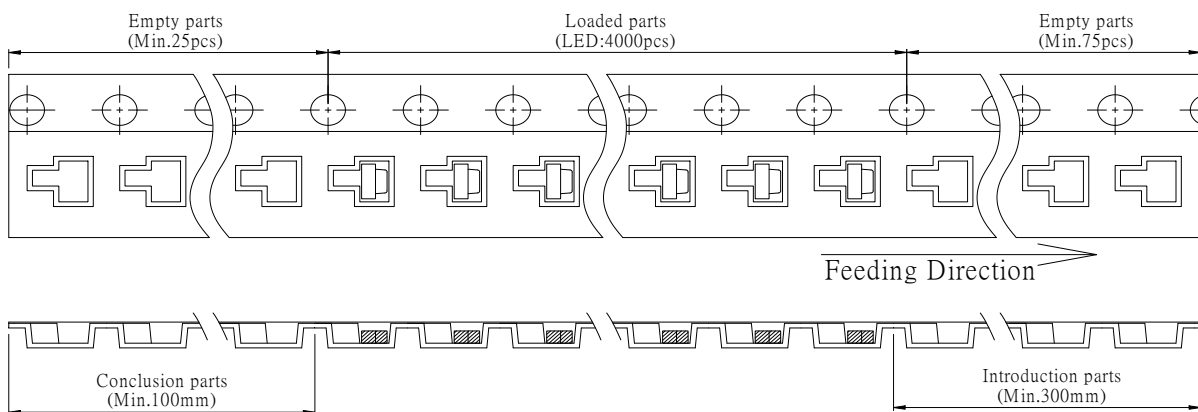

Notes:

1. Empty component pockets are sealed with top cover tape;
2. The maximum number of missing lamps is two;
3. The cathode is oriented towards the tape sprocket hole in accordance with ANSI/EIA RS-481 specifications.
4. 4,000 pcs/Reel.

2005 Series SMD Chip LED Lamps Packaging Specifications

- Packaging specifications

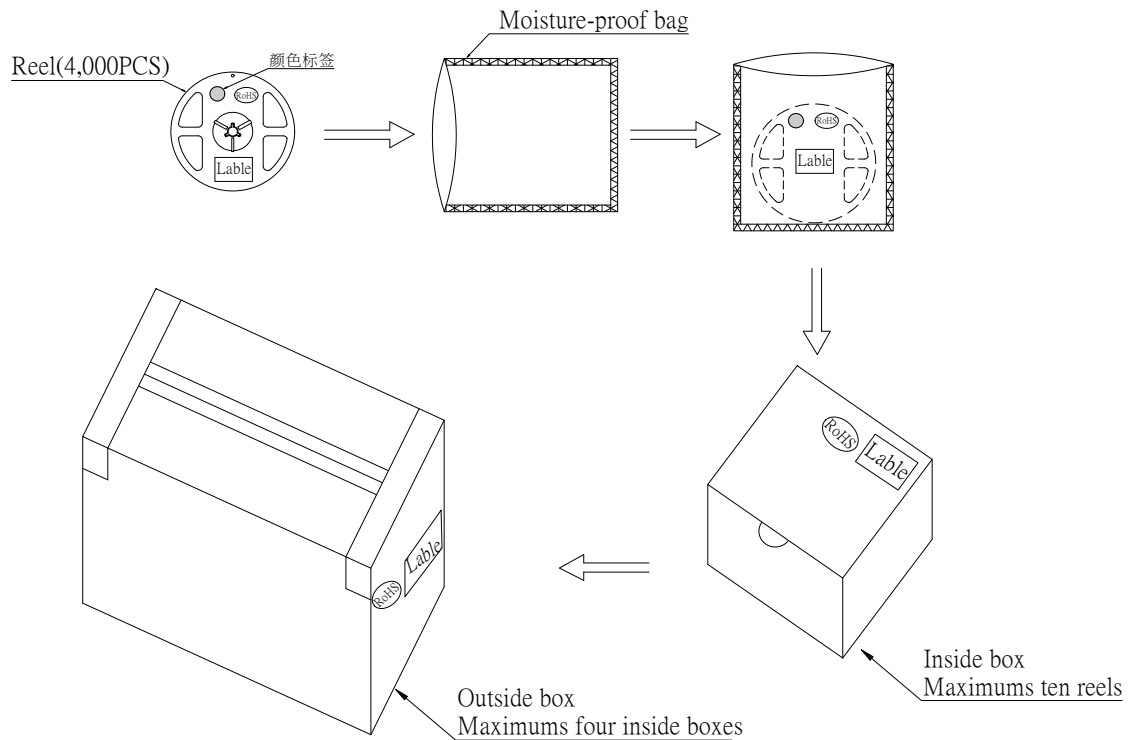

Notes:

Reeled products (numbers of products are 4,000pcs) packed in a seal off moisture-proof bag along with a desiccant one by one, ten moisture-proof bag of maximums (total maximum number of products are 40,000pcs) packed in an inside box (about size: 240x 220x 120mm) and four inside boxes of maximums are put in the outside box (about size: 460mm x 246mm x 250mm) Together with buffer material, and it is packed. (Part No., Lot No., quantity should appear on the label on the moisture-proof bag, part No. and quantity should appear on the label on the cardboard box.) The number of the loading steps of outside box (cardboard box) has it to three steps.