

# PRELIMINARY SPECIFICATIONS



Customer Part No.: \_\_\_\_\_ HELE. Part No: X3S024000B91HA-R  
Application For: \_\_\_\_\_ Products: CRYSTAL  
Accepted Model: \_\_\_\_\_ Type & Freq.: HSX321S / 24.000MHz  
Sample Order No: \_\_\_\_\_ Date: 2012/08/07

Approved By :

加高電子股份有限公司  
加高電子股份有限公司

**HARMONY ELECTRONICS CORP.**

**HARMONY ELECTRONICS (THAILAND) CO., LTD.**

**HARMONY ELECTRONICS (SHENZHEN) CORP., LTD.**

**TAIPEI OFFICE:**

公司:(114)  
台北市內湖區堤頂大道 2 段 409 號 2 樓  
2F., NO.409, SEC.2, TIDING BLVD.,  
NEIHU DISTRICT, TAIPEI CITY 114,  
TAIWAN (R.O.C.)  
TEL:886-2-26588883  
FAX:886-2-26588683

**TAIWAN FACTORY:**

工廠:(831)  
高雄市大寮區大發工業區華東路 39 號  
No.39, Hua dong Rd., Daliao Dist.,Dafa  
Industrial Park., Kaohsiung City 831,  
Taiwan (R.O.C.)  
TEL: (07)787-1555-6  
FAX: (07)787-1557

**THAILAND FACTORY:**

66MOO 5, KAONGU-BEOKPRAI RD.,  
T.BEOKPRAI, A. BANPONG,  
RAJCHABUREE PROVINCE 70110,  
THAILAND  
TEL: (032)221994-6, 200740-1  
FAX: (032)200742

**SHENZHEN FACTORY:**

深圳市福永鎮塘尾村塘橋路聚源工業區  
QIAO TANG RD., TANGWEI VILLAGE  
FU YONG TOWN SHENZHEN CITY  
CHINA  
TEL: 0755-7309272 / 7309262  
FAX: 0755-7309755

Title <b>HSX321S</b> <b>QUARTZ CRYSTAL SPECIFICATION</b>				Country of origin <b>TAIWAN FACTORY</b> <b>THAILAND FACTORY</b> <b>SHENZHEN FACTORY</b>		
Date	Confirm	Check	Prepare	Spec. No.	Rev.	Page
<b>2012/08/07</b>	F. S. TSAI	C. L. WANG	U. F. CHEN	<b>X3S024000B91HA-R</b>	0	1

**HARMONY ELECTRONICS CORP.**

# HSX321S SPECIFICATION

## INDEX

ITEM	PAGE
1. QUARTZ CRYSTAL UNIT SPECIFICATION . . . . .	3
2. MARKING & DIMENSIONS . . . . .	4
3. INSIDE STRUCTURE . . . . .	5
4. EMBOSS CARRIER TAPE&REEL . . . . .	
a. DIMENSIONS OF CARRIER TAPE . . . . .	6
b. DIMENSIONS OF REEL . . . . .	6-7
c. STORAGE CONDITION . . . . .	7
d. STANDARD PACKING QUANTITY . . . . .	7
e. MATERIAL OF TAPE . . . . .	7
f. LABEL CONTENTS . . . . .	7
g. TAPING DIMENSION . . . . .	8
h. JOINT OF TAPE . . . . .	8
i. RELEASE STRENGTH OF COVER TAPE . . . . .	8
j. PACKAGE . . . . .	9
5. MECHANICAL PERFORMANCE . . . . .	10
6. ENVIRONMENTAL PERFORMANCE . . . . .	10
7. SUPPLEMENT . . . . .	11-12
8. FLOW CHART . . . . .	13
9. Environmental Workload Chemical Substance Components List .	14
10. TEST DATA . . . . .	

Title <b>HSX321S</b> <b>QUARTZ CRYSTAL SPECIFICATION</b>				Country of origin <b>TAIWAN FACTORY</b> <b>THAILAND FACTORY</b> <b>SHENZHEN FACTORY</b>		
Date	Confirm	Check	Prepare	Spec. No.	Rev.	Page
<b>2012/08/07</b>	F. S. TSAI	C. L. WANG	U. F. CHEN	<b>X3S024000B91HA-R</b>	0	2

# 1. QUARTZ CRYSTAL UNIT SPECIFICATION

- |                                |   |
|--------------------------------|---|
| 1. Frequency:                  | 24.000000MHz  |
| 2. Holder type :               | <b>HSX321S</b>  |
| 3. Frequency tolerance:        | +/-10 ppm at 25deg.C +/-3deg.C  |
| 4. Equivalent resistance:      | 60 ohms Max. / SERIES   |
| 5. Storage temperature range:  | -40 deg.C To +85 deg.C  |
| 6. Operable temperature range: | -20 deg.C To +75 deg.C  |
| 7. Temperature drift:          | +/-10ppm                      -20 deg.C To +75 deg.C                        |
| 8. Loading capacitance (CL) :  | 9.0pF   |
| 9. Drive level:                | 10 uW (100uW Max)   |
| 10. Shunt Capacitance:         | 2.0 pF Max  |
| 11. Insulation resistance :    | More than 500M ohms at DC 100V  |
| 12. Mode of oscillation:       | Fundamental   |
| 13. Circuit:                   | Measured in HP/E5100A,S&A 250B  |
| 14. Shocking :                 | Dropping from 50 cm height 3 times on firm wood                             |
| Variation :                    | Frequency less than +/-5 ppm<br>Resistance less than +/- 15 % or 2ohms max. |
| 15. Aging:                     | Less than +/-5 ppm / Year   |
| 16. Holder                     | HSX321S Seam type   |
| 17. Dimensions and marking     | Refer to page.4   |
| 18. Emboss carrier tape & reel | Refer to page.6 and page.7  |
| 19. Note:                      |   |

Title <b>HSX321S</b> <b>QUARTZ CRYSTAL SPECIFICATION</b>				Country of origin <b>TAIWAN FACTORY</b> <b>THAILAND FACTORY</b> <b>SHENZHEN FACTORY</b>		
Date	Confirm	Check	Prepare	Spec. No.	Rev.	Page
<b>2012/08/07</b>	F. S. TSAI	C. L. WANG	U. F. CHEN	<b>X3S024000B91HA-R</b>	0	3

## 2. HSX321S MARKING & DIMENSIONS

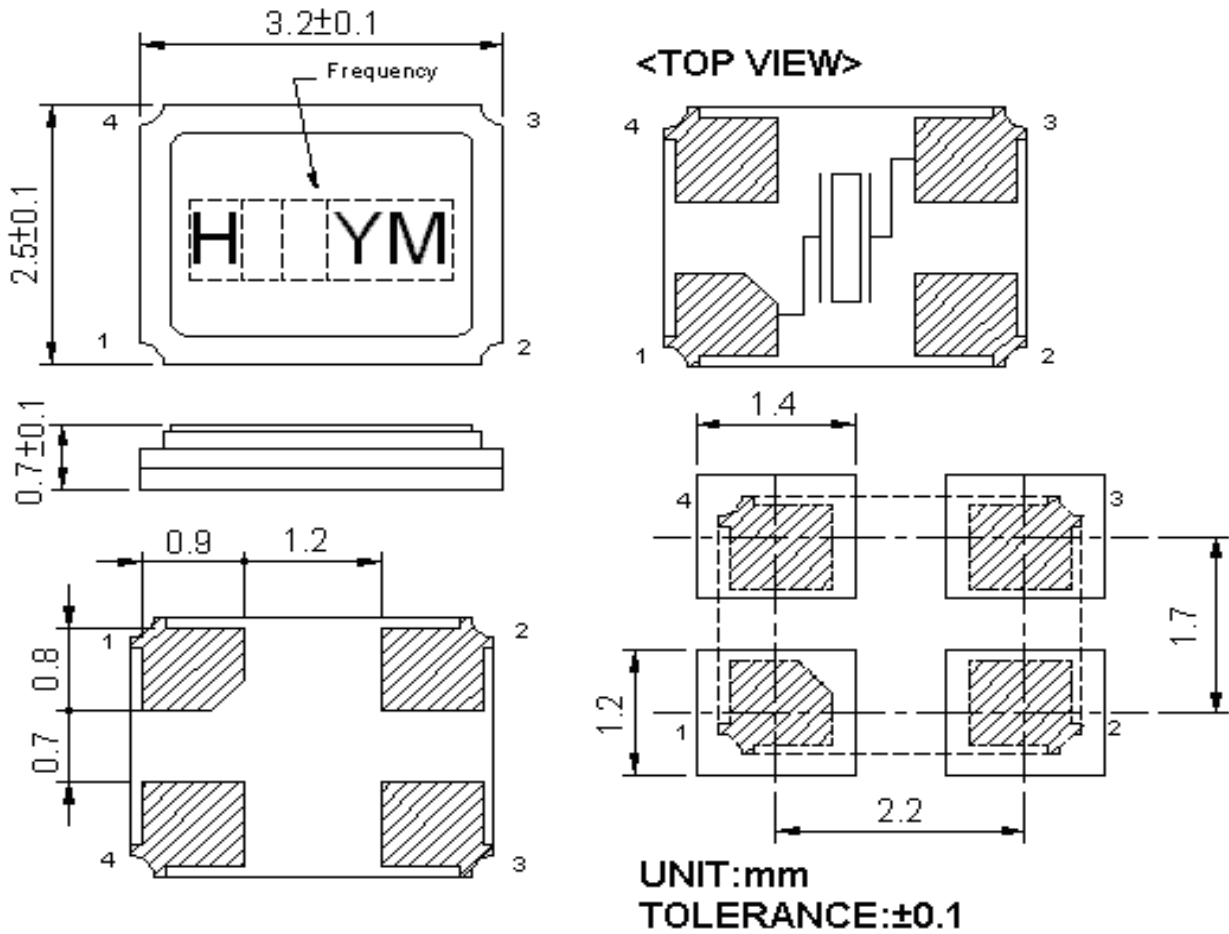

Chamfer index mark depends on the ceramic base supplier.

\*Marking should be printed as following:

Logo, Nominal Frequency, Manufactured year & month

\*Nominal frequency = integer only

( ex. 14.31818 MHz  $\rightarrow$  14 )

\*Manufacturing Lot No.

(Y: year) ex. 2000 shall be marked as ' 0 ' (As shown on the Table-1)

(M: month) ex. June shall be marked as ' F ' (As shown on the Table-2).

Marking : Laser marking.

(Table-1)

Year	2000	2001	2002	2003	2004	2005	2006	2007	2008	2009
	2010	2011	2012	2013	2014	2015	2016	2017	2018	2019
Code	0	1	2	3	4	5	6	7	8	9

(Table-2)

Jan.	Feb.	Mar.	Apr.	May.	Jun.	Jul.	Aug.	Sep.	Oct.	Nov.	Dec.
A	B	C	D	E	F	G	H	J	K	L	M

Title **HSX321S**  
**QUARTZ CRYSTAL SPECIFICATION**

Country of origin **TAIWAN FACTORY**  
**THAILAND FACTORY**  
**SHENZHEN FACTORY**

Date	Confirm	Check	Prepare	Spec. No.	Rev.	Page
2012/08/07	F. S. TSAI	C. L. WANG	U. F. CHEN	<b>X3S024000B91HA-R</b>	0	4

**HARMONY ELECTRONICS CORP.**

### 3. INSIDE STRUCTURE

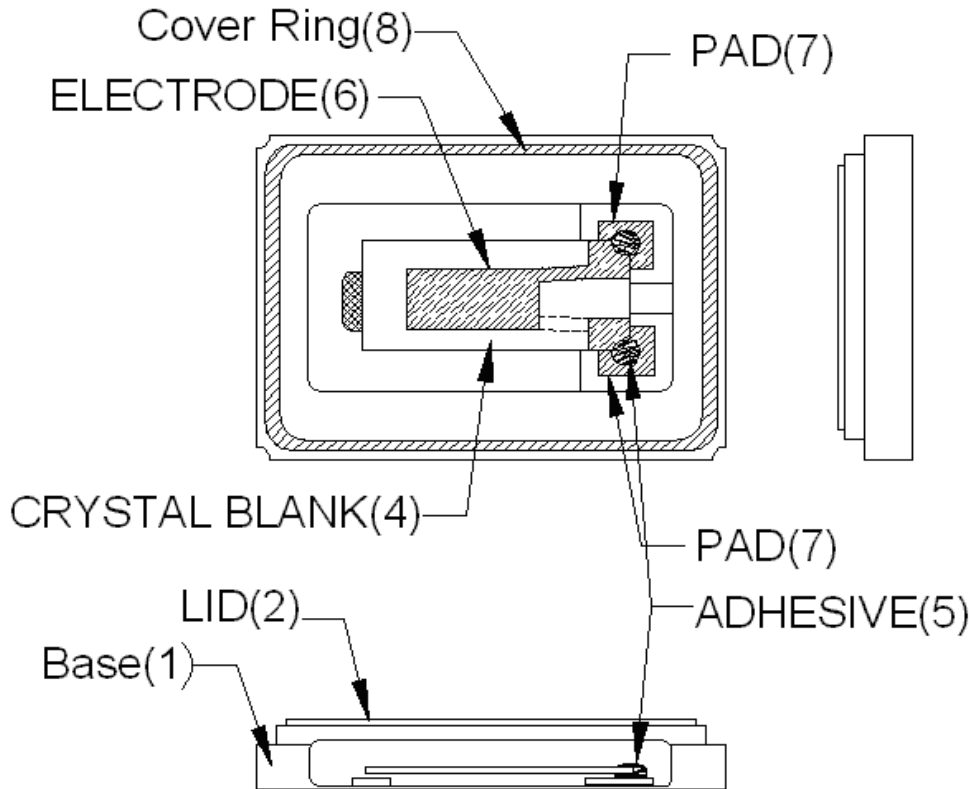

※Reference drawing

1) Base: Alumina Ceramic ( $Al_2O_3$ ) Metallized Pad: Ni Plating Au Plating
(2) Lid : Fe- Ni -Co
(3) Crystal Enclosure Seal: Seal Seam
(4) Crystal Blank Rectangular At-Cut Quartz Crystal Blank
(5) Adhesive Silver Conductive Silicon Resin Adhesive bonding: upper & lower bonding/lower bonding only
(6) Electrode
(7) PAD Alumina Ceramic (Ni. Au)
(8) Cover Ring : Fe-Ni-Co Alloy

The use prohibition chemistry substance of Table 1 of DHE-0204-1 (HE-QA-24) is not included in this item.

Title <b>HSX321S</b> <b>QUARTZ CRYSTAL SPECIFICATION</b>				Country of origin <b>TAIWAN FACTORY</b> <b>THAILAND FACTORY</b> <b>SHENZHEN FACTORY</b>		
Date	Confirm	Check	Prepare	Spec. No.	Rev.	Page
2012/08/07	F. S. TSAI	C. L. WANG	U. F. CHEN	<b>X3S024000B91HA-R</b>	0	5

#### 4. HSX321S EMBOSS CARRIER TAPE & REEL

##### a.) Dimensions of Carrier Tape

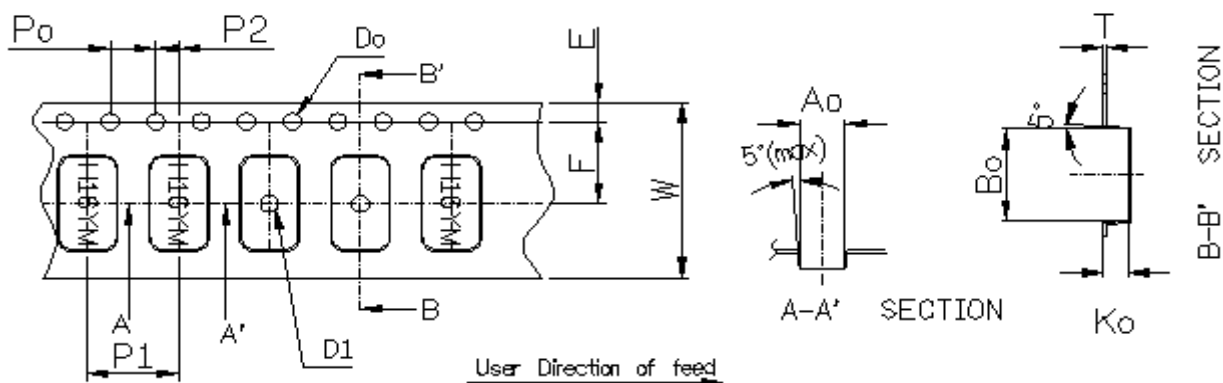

Symbol	Ao	Bo	Ko	Po	P1	P2
Spec	2.70±0.1	3.4±0.1	1.40±0.1	4.0±0.1	4.0±0.1	2.0±0.05
Symbol	E	F	Do	D1	W	T
Spec	1.75±0.1	3.5±0.05	∅1.55±0.05	∅1.0(min)	8.0±0.2	0.25±0.05

##### b.) Dimensions of Reel

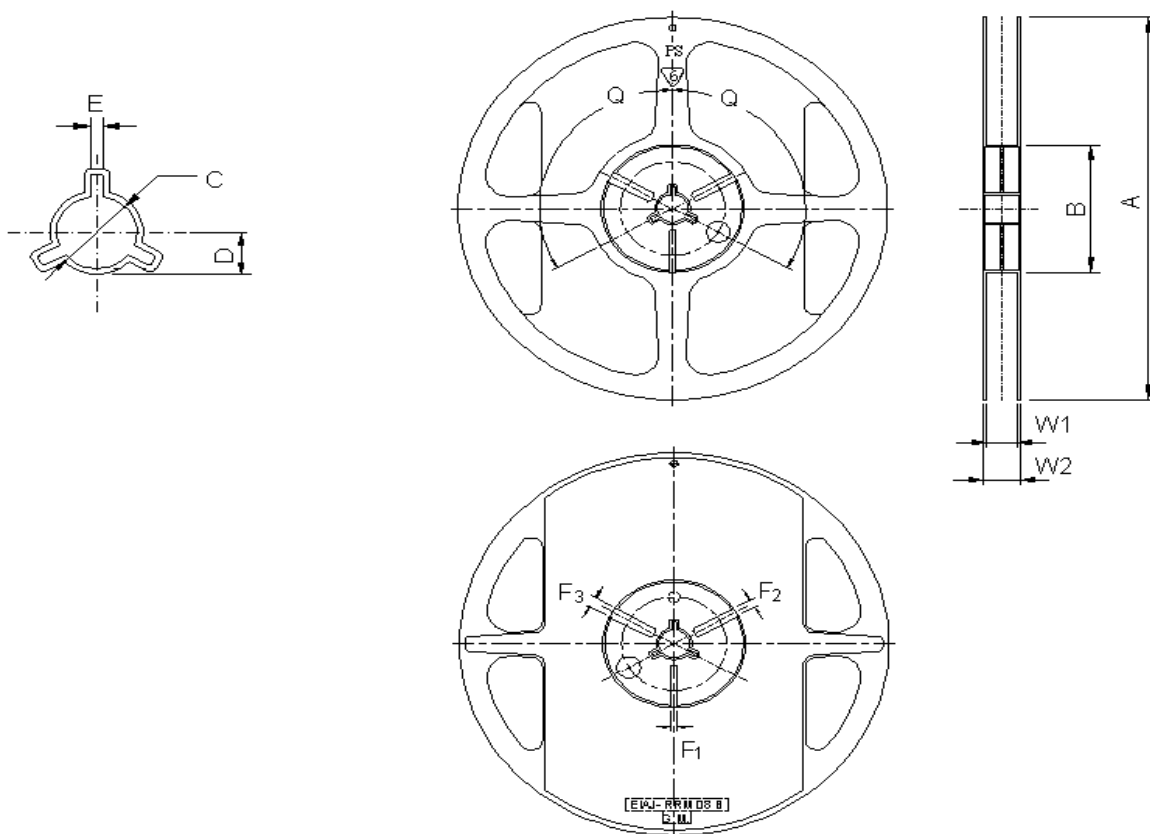

Title <b>HSX321S</b> <b>QUARTZ CRYSTAL SPECIFICATION</b>				Country of origin <b>TAIWAN FACTORY</b> <b>THAILAND FACTORY</b> <b>SHENZHEN FACTORY</b>		
Date	Confirm	Check	Prepare	Spec. No.	Rev.	Page
2012/08/07	F. S. TSAI	C. L. WANG	U. F. CHEN	<b>X3S024000B91HA-R</b>	0	6

(Table-2)

(UNIT: mm)

ITEM		MARK	DIMENSIONS · ANGLE	
FLANCE	Diameter	A	$\phi$ 180+0/-3	
	Inner Width	W1	9.3+/-0.3	
	Outer Width	W2	11.3+/-1.0	
HUB	Out Line diameter	B	$\phi$ 60.5+/-0.5	
	Center Core slit	Width	F1	3.0+0.5/-0
			F2	4.0+0.5/-0
			F3	5.0+0.5/-0
		Position	q	120deg
	Spindle diameter		C	$\phi$ 13.2+/-0.5
Key Ditch	Width	E	3.0+/-0.2	

## c.) Storage condition

Temperature: +40deg.C Max.

Relative Humidity: 80% Max.



## d.) Standard packing quantity

3,000PCS / REEL

## e.) Material of the tape

Tape	Material
Carrier tape	PS Conductive
Top tape	Polyester

## f.) Label contents

	
TYPE:	
SPEC.No.:	
Parts No.:	
LotNo.:	
FREQ.:	MHz
Q'TY:	PCS
HARMONY ELECTRONICS CORP.  HSF	

Sticks label for every reel.

Title <b>HSX321S</b> <b>QUARTZ CRYSTAL SPECIFICATION</b>				Country of origin <b>TAIWAN FACTORY</b> <b>THAILAND FACTORY</b> <b>SHENZHEN FACTORY</b>		
Date	Confirm	Check	Prepare	Spec. No.	Rev.	Page
2012/08/07	F. S. TSAI	C. L. WANG	U. F. CHEN	<b>X3S024000B91HA-R</b>	0	7

HARMONY ELECTRONICS CORP.

g.) Taping dimension

Leader	Cover-tape	The length of cover-tape in the leader is more than 400 mm including empty embossed area.
	Carrier-tape	After all products were packaged, must remain more than twenty pieces or 400 mm empty area, which should be sealed by cover-tape.
Terminal	Cover-tape	The tip of cover-tape shall be fixed temporary by paper tape and roll around the core of reel one round.
	Carrier-tape	The empty embossed area which are sealed by top cover-tape must remain more the 40 mm.

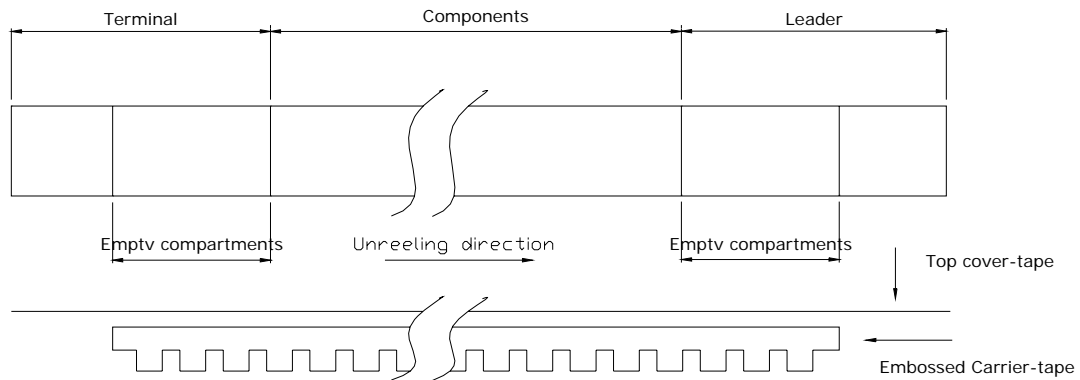

h.) Joint of tape

The carrier-tape and top cover-tape should not be jointed.

i.) Release strength of cover tape

It has to between 0.1N to 0.7N under following condition.

Pulling direction 165° to 180°

Speed 300mm/min.

Otherwise unless specified.

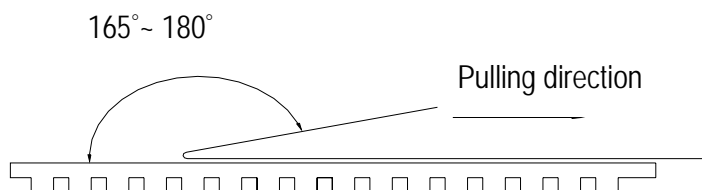

Other standards shall be based on JIS C 0806-1990.

Title <b>HSX321S</b> <b>QUARTZ CRYSTAL SPECIFICATION</b>				Country of origin <b>TAIWAN FACTORY</b> <b>THAILAND FACTORY</b> <b>SHENZHEN FACTORY</b>		
Date	Confirm	Check	Prepare	Spec. No.	Rev.	Page
<b>2012/08/07</b>	F. S. TSAI	C. L. WANG	U. F. CHEN	<b>X3S024000B91HA-R</b>	0	8



j.) Package

1. Reel :  $\varnothing 180$

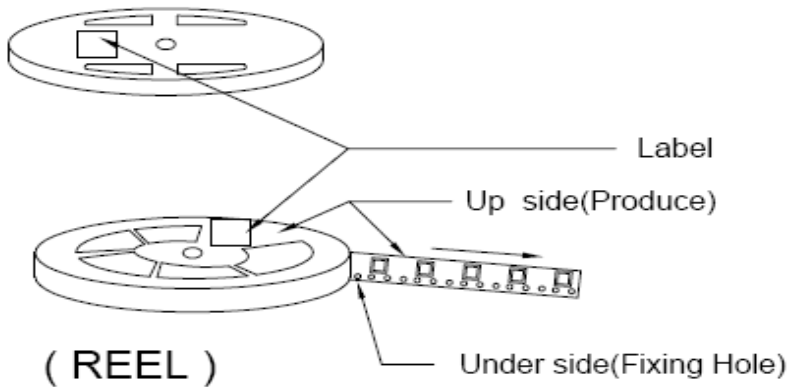

**2. Carton** One reel quantity: [ 1000pcs ] & [ 3000pcs ]

- ① Top and bottom with 2.3cm thickness foam-rubber cushion for protection.
- ② Carton's Q'TY: 1~15 pcs.
- ③ Carton Type=A,B,C use 4 trigon pillar to fasten the Reel.
- ④ Need to add 3 pages dry agent in each outer box.

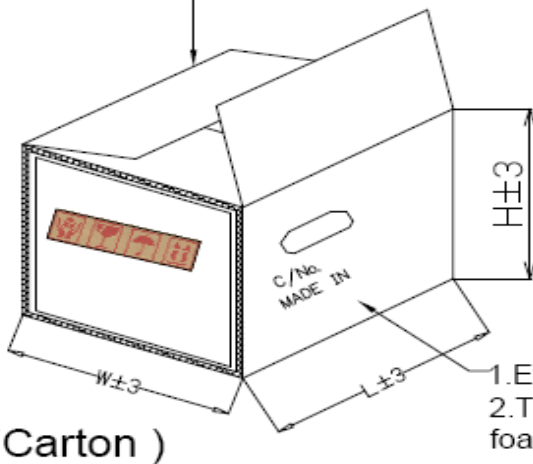
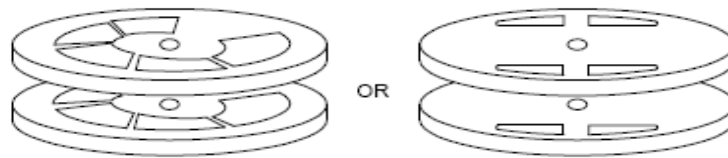

Carton Type	A	B	C	D
Produce Type	840/751	630/531/ 421	321/21	OTHER
Reel	15	15	15	1~7
L±3	200	200	200	195
W±3	200	200	200	195
H±3	230	230	230	150

- 1. Every Carton with 3 desiccant.
- 2. Top and bottom with 2.3cm thickness foam-rubber cushion for protection

Title <b>HSX321S</b> <b>QUARTZ CRYSTAL SPECIFICATION</b>				Country of origin <b>TAIWAN FACTORY</b> <b>THAILAND FACTORY</b> <b>SHENZHEN FACTORY</b>		
Date	Confirm	Check	Prepare	Spec. No.	Rev.	Page
2012/08/07	F. S. TSAI	C. L. WANG	U. F. CHEN	<b>X3S024000B91HA-R</b>	0	9

## 5. Mechanical Performance

Item		Test Methods	Specifications Code
1	Natural Drop	Drop 3 times from the height of 50cm onto min. 30mm thickness hard wooden board.	A
2	Vibration	Frequency 10-55Hz, Sine Wave full amplitude of 0.8mm to X, Y and Z 3 axes, Duration of 2 hours to each axis.	A
3	Sealing Tightness	Leak Rate $1.0 \times 10^{-8}$ Pa-m <sup>3</sup> /sec. Max. Measured by Helium leak detector. – Fine Leakage.	---
4	Solder ability	After applying ROSIN Flux, dipping in solder bath at 245deg.C +/- 5deg.C for 3 +/- 0.5 sec.	B

## 6. Environment Performance

Item		Test Methods	Specifications Code
1	Humidity	Temperature 60°C +/- 2°C, RH 90~95%, Duration of 240 hours. Back to room temperature first, then in 1~2 hours, the component shall be checked.	A
2	Storage in Low Temperature	-40deg.C +/- 2deg.C, Duration of 240 hours. Back to the room temperature first, then in 1~2 hours, the component shall be checked.	A
3	Storage in High Temperature	+85deg.C +/- 2deg.C, Duration of 240 hours. Back to the room temperature first, then in 1~2 hours, the component shall be checked.	A
4	Temperature cycles	-40deg.C +/- 2deg.C (30min) ↔ +85deg.C +/- 2deg.C (30min) 25 cycles. Back to the room temperature first, then in 1~2 hours, the component shall be checked.	A

Specifications code	Specifications
A	Frequency variation shall be within +/- 5ppm and equivalent resistance shall be within the specification after the test
B	More than 90% of lead shall be covered by new solder.

Title <b>HSX321S</b> <b>QUARTZ CRYSTAL SPECIFICATION</b>				Country of origin <b>TAIWAN FACTORY</b> <b>THAILAND FACTORY</b> <b>SHENZHEN FACTORY</b>		
Date	Confirm	Check	Prepare	Spec. No.	Rev.	Page
2012/08/07	F. S. TSAI	C. L. WANG	U. F. CHEN	<b>X3S024000B91HA-R</b>	0	10

## 7. Supplement

### 7.1.Soldering

7.2.Please stay with our proposed reflow condition and do then soldering 2 times max.

**Available for Lead Free Soldering**

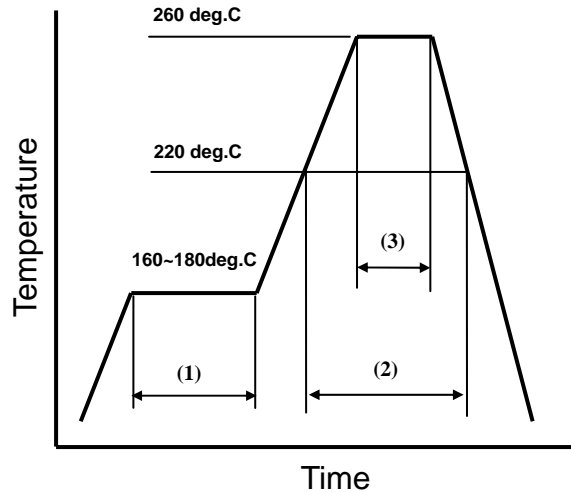

(1)	Preheat	160~180 deg.C	120sec.
(2)	Primary heat	220 deg.C	60sec.
(3)	Peak	260 deg.C	10sec. Max.

### 7.3.Land pattern layout(Example)

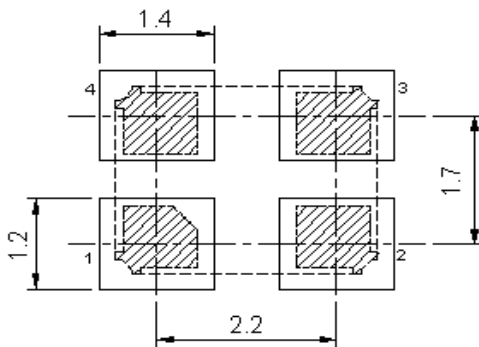

### 7.4.Solder iron (Example)

Bit temp.:350°C max.,Time:3sec max. ,Each terminal solder a 1 time max.

Title <b>HSX321S</b> <b>QUARTZ CRYSTAL SPECIFICATION</b>				Country of origin <b>TAIWAN FACTORY</b> <b>THAILAND FACTORY</b> <b>SHENZHEN FACTORY</b>		
Date	Confirm	Check	Prepare	Spec. No.	Rev.	Page
<b>2012/08/07</b>	F. S. TSAI	C. L. WANG	U. F. CHEN	<b>X3S024000B91HA-R</b>	0	11

**HARMONY ELECTRONICS CORP.**

#### 7.5.Mounting

This component is designed for automatic insertion.

However, you are requested to do the trial with your insertion machine in order to be sure of proper operation and no damage of component.

Please pay attention to board warp which may damage the component and cause Soldering Process.

#### 7.6.Cleaning

Cleaning liquid which corrodes Nickel shall not be used

It may cause the problem on the surface, color, marking etc.

Ultra-sonic cleaning is possible, however, you are requested to check on your board.

Because we only checked as single unit.

#### 7.7.Storage

Please keep away from high temperature and high humidity ,which may cause put solderbility. No direct Sunlight, No dew as well.

Title <b>HSX321S</b> <b>QUARTZ CRYSTAL SPECIFICATION</b>				Country of origin <b>TAIWAN FACTORY</b> <b>THAILAND FACTORY</b> <b>SHENZHEN FACTORY</b>		
Date	Confirm	Check	Prepare	Spec. No.	Rev.	Page
<b>2012/08/07</b>	F. S. TSAI	C. L. WANG	U. F. CHEN	<b>X3S024000B91HA-R</b>	0	12

### 8. Flow Chart

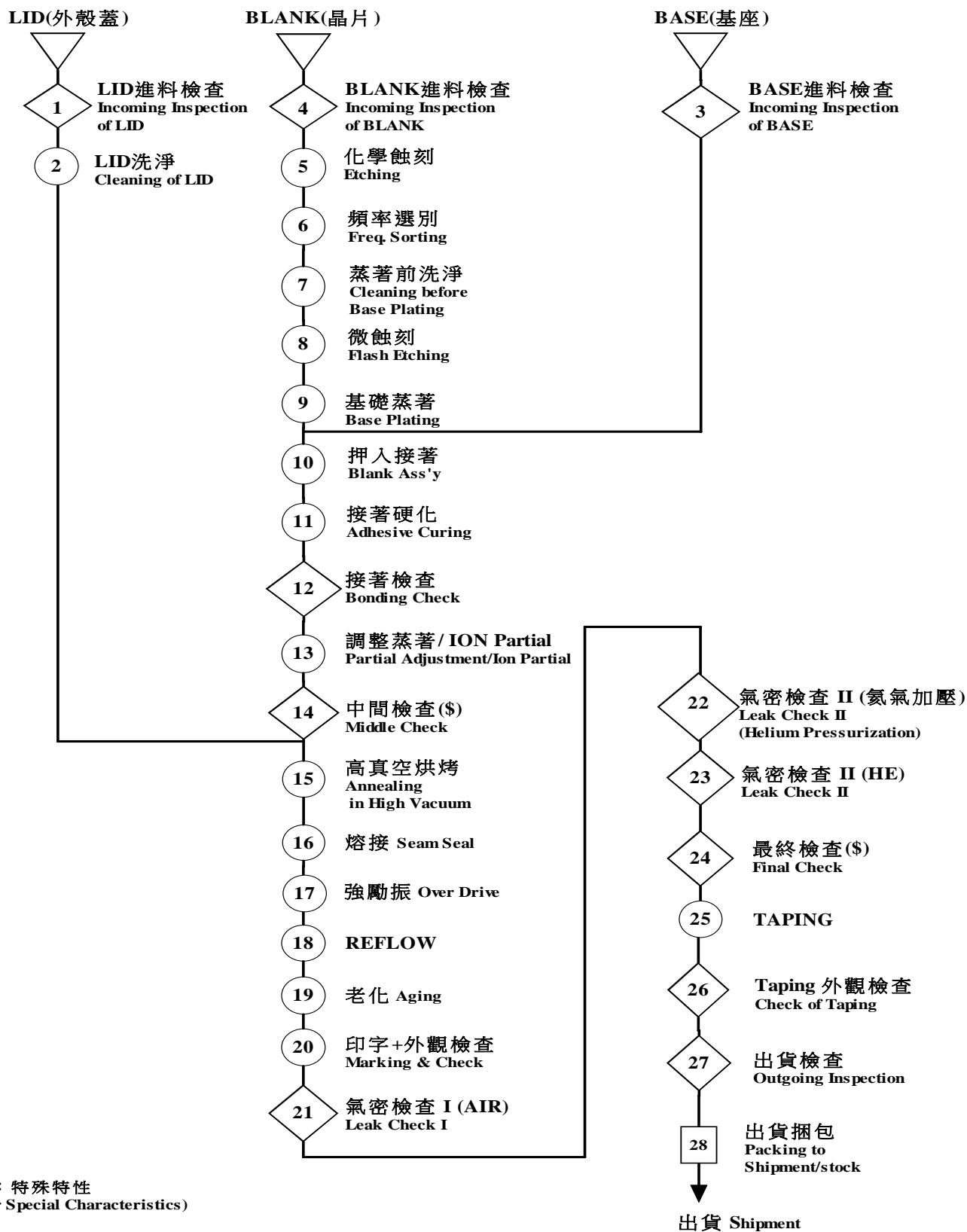

Title <b>HSX321S</b> <b>QUARTZ CRYSTAL SPECIFICATION</b>				Country of origin <b>TAIWAN FACTORY</b> <b>THAILAND FACTORY</b> <b>SHENZHEN FACTORY</b>		
Date	Confirm	Check	Prepare	Spec. No.	Rev.	Page
2012/08/07	F. S. TSAI	C. L. WANG	U. F. CHEN	<b>X3S024000B91HA-R</b>	0	13

**9. Environmental Workload Chemical Substance Components List**

<b>Environmental Workload Chemical Substance Components List</b>		
<b>Chemical Substance Components</b>	<b>TYPE</b>	<b>H(D)SX321S</b>
	<b>PERCENTAGE</b>	
		<b>20.5(mg)                  ppm</b>
<b>Si</b>		<b>0.04715                  9.6658</b>
<b>Au</b>		<b>0.15785                  32.3593</b>
<b>Co &amp; Co Compound</b>		<b>1.21770                  249.6285</b>
<b>Mo &amp; Mo Compound</b>		<b>0.04100                  8.4050</b>
<b>Ag</b>		<b>0.42640                  87.4120</b>
<b>Cu</b>		<b>0.11890                  24.3745</b>
<b>Cr &amp; Cr Compound</b>		<b>0.04100                  8.4050</b>
<b>Al</b>		<b>5.09630                  1044.7415</b>
<b>Mn &amp; Mn Compound</b>		<b>0.02460                  5.0430</b>
<b>W &amp; W Compound</b>		<b>0.19885                  40.7643</b>
<b>Ni &amp; Ni Compound</b>		<b>3.06680                  628.6940</b>
<b>Fe</b>		<b>4.14715                  850.1658</b>

<b>Title HSX321S QUARTZ CRYSTAL SPECIFICATION</b>				<b>Country of origin</b> <b>TAIWAN FACTORY</b> <b>THAILAND FACTORY</b> <b>SHENZHEN FACTORY</b>		
<b>Date</b>	<b>Confirm</b>	<b>Check</b>	<b>Prepare</b>	<b>Spec. No.</b>	<b>Rev.</b>	<b>Page</b>
<b>2012/08/07</b>	<b>F. S. TSAI</b>	<b>C. L. WANG</b>	<b>U. F. CHEN</b>	<b>X3S024000B91HA-R</b>	<b>0</b>	<b>14</b>

