

ELECTRONICS



Metal Oxide Varistors

RL0603E Series

Metal Oxide Varistors - RL0603E Series

Features

1. Excellent ESD clamping & Small Insertion Loss
2. High transient current capability, Fastest response time
3. Capacitance is designed to ultra-low value, which can be efficiently suitable to high speed data line.
4. EU-RoHS Compliance

Product Name

R	L	0	6	0	3	E	0	0	5	M	0	1	5	K
Brand Name		EIA 0603			Type E:ESD		Varistor Voltage			M±30%		capacitance 0.15PF=015		Type

Package Dimensions

Unit:mm

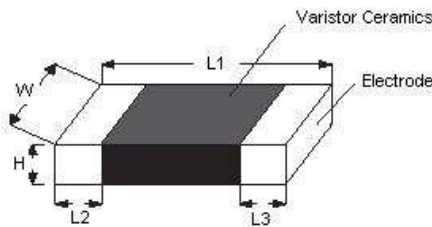

EIA	L1(mm)	W(mm)	H(mm)	L2&L3(mm)
0603	1.60±0.15	0.80±0.15	0.95	0.35±0.15

Metal Oxide Varistors - RL0603E Series

Electrical Characteristics

Part Number	Max. Operating Voltage	Max. Leakage Current	capacitance	Trigger Voltage	Clamping Voltage	Attenuation	esd capability3 Cont.Discharge
	V _{DC} (V)	(μ A)	@1MHz(Cp)	(V)	(V)		
RL0603E005M005K	5	0.001	0.05	450	50	-3dB at 5GHz	8KV
RL0603E005M015K	5	0.05	0.15	250	50	-3dB at 5GHz	8KV
RL0603E005M250K	5	1	2.5	200	50	-	8KV
RL0603E005M500K	5	1	5	15	25	-	8KV
RL0603E012M005K	12	0.05	0.05	250	50	-3dB at 5GHz	8KV
RL0603E012M015K	12	1	0.15	200	50	-3dB at 5GHz	8KV
RL0603E012M100K	12	1	1	200	50	-	8KV
RL0603E018M015K	18	1	0.15	250	50	-3dB at 5GHz	8KV
RL0603E018M100K	18	1	1	200	50	-	8KV
RL0603E018M300K	18	1	3	125	50	-	8KV
RL0603E024M015K	24	1	0.15	200	50	-3dB at 5GHz	8KV
RL0603E024M250K	24	1	2.5	200	50	-	8KV

Notes:

1. Leakage current at Max. operating Voltage

2. Capacitance is measured with 1Vrms

3. per IEC 61000-4-2, 30A@8KV, level 4, clamp measurement made 30ns after initiation of pulse, all test IN contact discharge mode.

Metal Oxide Varistors - RL0603E Series

Electrical Rating

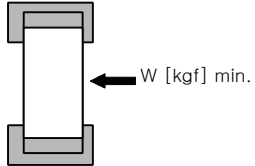
No	Item	Test Condition / Description	Requirement
1	Operation Range	1. -40°C ~ 85°C	-
2	Leakage current	Satisfaction to the specification, under 1uA	Applied voltage : specified working voltage
3	Capacitance	Satisfaction to the specification, under 1pF	Frquency & OSC level : 1MHz, 1.0Vrms
4	Solderability	More than 90% of the terminal electrode shall be covered with new solder.	1. Type of solder : H63A 2. Soldering Temp & Time : 230+/-5°C, 5+/-1 sec
5	Reflow soldering	1. No Serious mechanical damage 2. More than 50% of the terminal electrode shall be covered with new solder 3. Leakage Current :≤ 10uA	1. Type of solder : H63A 2. Temp & Time : max 260+/-5°C, min 10sec * Refer to the soldering profile of page 6
6	Humidity Load Test	1. No Serious mechanical damage 2. Leakage Current :≤ 10uA	Test Temp. & Relative Humidity & Time : 85+/- 5°C, 85 +/- 5% RH, Vw Applied, 500 +/- 12hrs
7	Thermal Shock	1. No Serious mechanical damage 2. Leakage Current :≤ 10uA	1. Step 1 : -40 +/- 5°C, Step 2 : 85 +/- 5°C 2. Cycle : 30min ± 3min, each 5 cycles
8	High Temp. Test	1. No Serious mechanical damage 2. Leakage Current :≤ 10uA	Temp. & time : 85+/-5°C , 1000 +/- 24hrs
9	Adhesive strength	1. No Serious mechanical damage under condition of 1005 : min 0.5kgf, 1608 : min 1.0kgf	
10	ESD	1. No mechanical damage after test 2. Leakage Current :≤ 10uA * ESD gun (IEC61000-4-2 standard) * C=150pF R=330Ω	1. Contact discharge * Voltage :+/-8kV(Level 4) * Number : 10 times in 10sec 2. Air discharge * Voltage :+/-15kV(Level 4) * Number : 10 times in 10sec

Packing specifications

1. Carrier tape

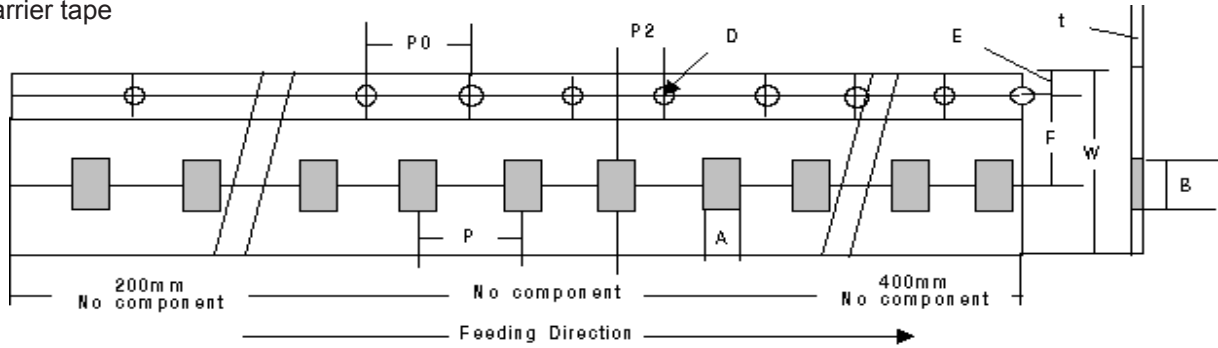

Unit:mm

Size	A	B	W	D	E	F	P	P0	P2	t
0603	1.10+/-0.10	1.90+/-0.10	8.00+/-0.20	1.50+/-0.25	1.75+/-0.10	3.50+/-0.50	4.0+/-0.1	4.0+/-0.10	2.0+/-0.10	1.1max

2. Reel & Label

[Plastic Reel]

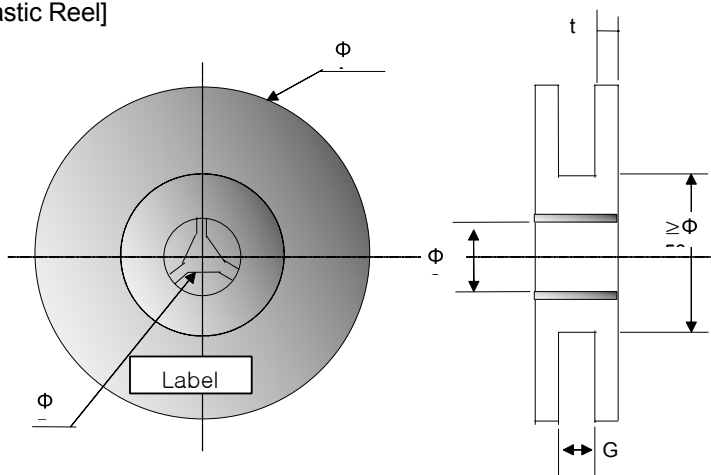

Unit:mm

Code	dimension
ΦA	178+/-2.0
ΦB	13.0+/-0.5
ΦC	22.0+/-2.0
G	10.0+/-1.5
t	2.5+/-0.5

Frequency properties ; Cp, Insertion Loss

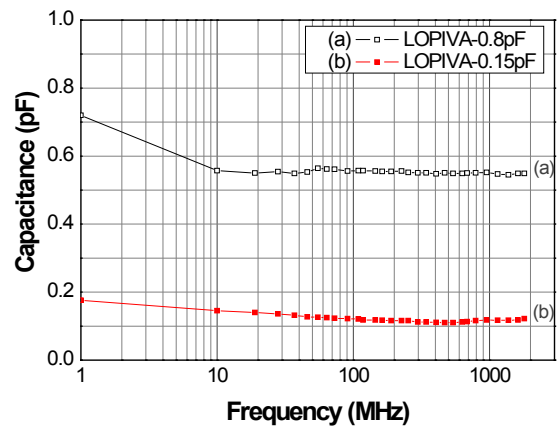
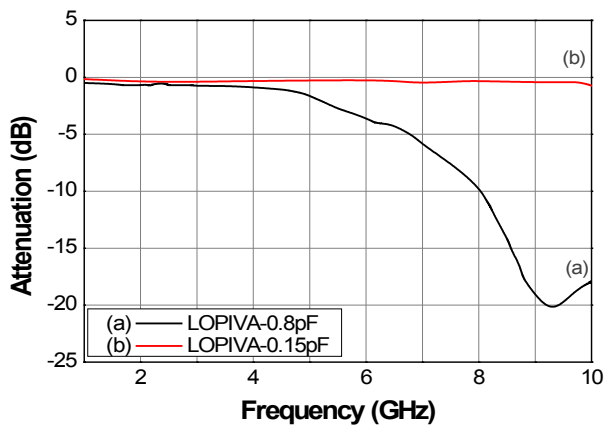

Packing specifications

1) Land Pattern Design

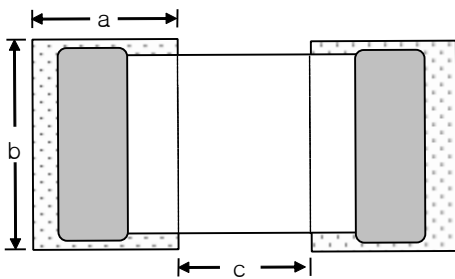

Code	Land Dimension with Chip Size [mm]			
	0201	0402	0603	0805
a	0.20~0.35	0.30~0.50	0.60~0.70	0.60~0.70
b	0.25~0.40	0.40~0.60	0.60~0.80	0.80~1.10
c	0.25~0.40	0.30~0.50	0.60~0.80	1.00~1.20

2) Reflow Soldering

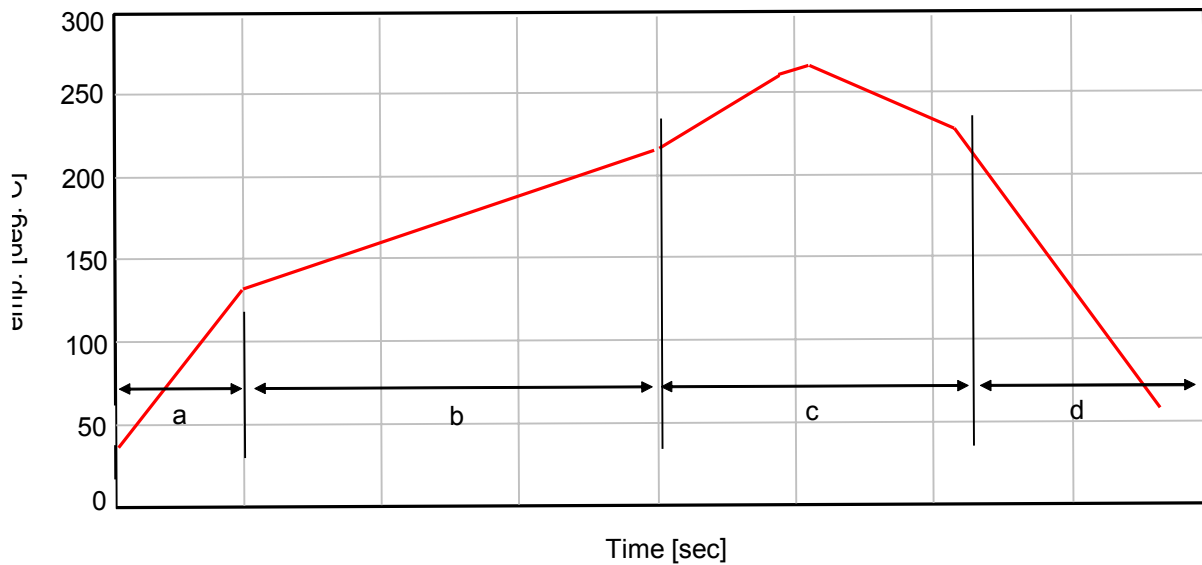

Zone	temp. range [deg. C]	time [sec]	Remark
a	Curing RT ~ 130	60	* Solder : Sn-Ag-Cu * 260deg. C, over 10sec
b	Preheat max 220	90 ~ 150	
c	Soldering 220 ~ 260 [max 270]	90 ~ 150	
d	Cooling 220 ~ RT	min 60	

3) Soldering Iron

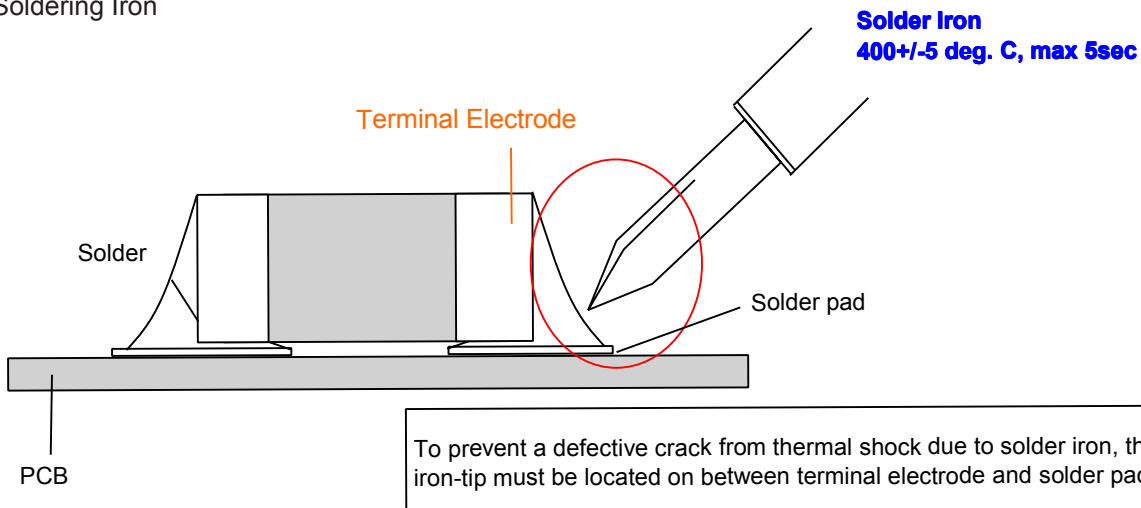

RuiLongYuan Electronics Co., Ltd.

- Reproducing and modifying information of the document is prohibited without permission from Ruilongyuan International Inc.
 - Ruilongyuan International Inc. reserves the rights to make changes of the content herein the document anytime without notification. Please refer to our website for the latest document.
 - Ruilongyuan International Inc. disclaims any and all liability arising out of the application or use of any product including damages incidentally and consequentially occurred.
 - Ruilongyuan International Inc. does not assume any and all implied warranties, including warranties of fitness for particular purpose, non-infringement and merchantability.
 - Applications shown on the herein document are examples of standard use and operation. Customers are responsible in comprehending the suitable use in particular applications. Ruilongyuan International Inc. makes no representation or warranty that such applications will be suitable for the specified use without further testing or modification.
 - The products shown herein are not designed and authorized for equipments requiring high level of reliability or relating to human life and for any applications concerning life-saving or life-sustaining, such as medical instruments, transportation equipment, aerospace machinery et cetera. Customers using or selling these products for use in such applications do so at their own risk and agree to fully indemnify Ruilongyuan International Inc. for any damages resulting from such improper use or sale.
-