

# TLV717P 150-mA, Low-Dropout Regulator With Foldback Current Limit for Portable Devices

## 1 Features

- Very Low Dropout: 215 mV at 150 mA
  - Accuracy: 0.5% (typical)
  - Low  $I_Q$ : 35  $\mu$ A
  - Available in Fixed-Output Voltages: 1.2 V to 5 V
  - High PSRR:
    - 70 dB at 1 kHz
    - 50 dB at 1 MHz
  - Stable With Effective Output Capacitance: 0.1  $\mu$ F
  - Foldback Current Limit
  - Package: 1-mm  $\times$  1-mm DQN
- (1) See the Package Option Addendum at the end of this document for a complete list of available voltage options.
- (2) See [Input and Output Capacitor Requirements](#) for more details.

## 2 Applications

- PCs and Notebooks
- Smart Phones
- Portable Electronics and Battery-Powered Devices
- Electronic Point of Sale

## 3 Description

The TLV717P series of low-dropout (LDO) linear regulators are low quiescent current LDOs with excellent line and load transient performance and are designed for power-sensitive applications. These devices provide a typical accuracy of 0.5%.

The TLV717P series offer current foldback that throttles down the output current with a decrease in load resistance. The typical value at which current foldback initiates is 350 mA; the typical value of the output short current limit value is 40 mA.

Furthermore, these devices are stable with an effective output capacitance of only 0.1  $\mu$ F. This feature enables the use of cost-effective capacitors that have higher bias voltages and temperature derating. The devices regulate to specified accuracy with no output load.

The TLV717P series is available in a 1-mm  $\times$  1-mm DQN package that makes them ideal for hand-held applications. The TLV717P provides an active pulldown circuit to quickly discharge output loads.

### Device Information<sup>(1)</sup>

PART NUMBER	PACKAGE	BODY SIZE (NOM)
TLV717P	X2SON (4)	1.00 mm $\times$ 1.00 mm

(1) For all available packages, see the orderable addendum at the end of the data sheet.

### Typical Application Circuit

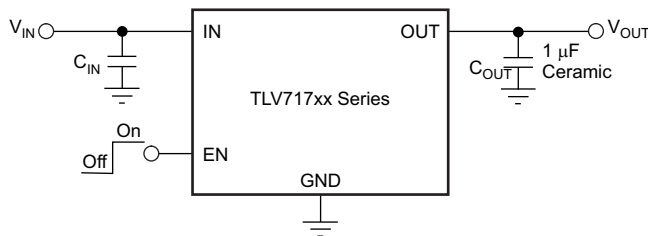

Copyright © 2016, Texas Instruments Incorporated



## Table of Contents

<b>1 Features</b> ..... 1 <b>2 Applications</b> ..... 1 <b>3 Description</b> ..... 1 <b>4 Revision History</b> ..... 2 <b>5 Pin Configuration and Functions</b> ..... 3 <b>6 Specifications</b> ..... 4 6.1 Absolute Maximum Ratings ..... 4 6.2 ESD Ratings ..... 4 6.3 Recommended Operating Conditions ..... 4 6.4 Thermal Information ..... 4 6.5 Electrical Characteristics ..... 5 6.6 Typical Characteristics ..... 6 <b>7 Detailed Description</b> ..... 9 7.1 Overview ..... 9 7.2 Functional Block Diagram ..... 9 7.3 Feature Description ..... 9 7.4 Device Functional Modes ..... 10	<b>8 Application and Implementation</b> ..... 11 8.1 Application Information ..... 11 8.2 Typical Application ..... 11 <b>9 Power Supply Recommendations</b> ..... 13 <b>10 Layout</b> ..... 13 10.1 Layout Guidelines ..... 13 10.2 Layout Example ..... 13 10.3 Power Dissipation ..... 13 <b>11 Device and Documentation Support</b> ..... 14 11.1 Device Support ..... 14 11.2 Documentation Support ..... 14 11.3 Community Resource ..... 14 11.4 Trademarks ..... 14 11.5 Electrostatic Discharge Caution ..... 14 11.6 Glossary ..... 14 <b>12 Mechanical, Packaging, and Orderable Information</b> ..... 15
---	---

## 4 Revision History

NOTE: Page numbers for previous revisions may differ from page numbers in the current version.

Changes from Revision A (February 2012) to Revision B	Page
• Deleted all instances of TLV717xx; Replaced with generic part number, TLV717P	1
• Updated <i>Applications</i> .	1
• Added <i>ESD Ratings</i> table, <i>Feature Description</i> section, <i>Device Functional Modes</i> , <i>Application and Implementation</i> section, <i>Power Supply Recommendations</i> section, <i>Layout</i> section, <i>Device and Documentation Support</i> section, and <i>Mechanical, Packaging, and Orderable Information</i> section	1
• Changed $T_J = -25^{\circ}\text{C}$ to $T_J = 25^{\circ}\text{C}$ in the conditions statement in <i>Absolute Maximum Ratings</i> .	4
• Changed $T_A$ to $T_J$ throughout <i>Electrical Characteristics</i> .	5
• Changed $T_A$ to $T_J$ in the conditions statement in <i>Typical Characteristics</i> .	6
• Changed $T_A$ to $T_J$ in the conditions statement in <i>Typical Characteristics</i> .	7
• Changed $T_A$ to $T_J$ in the conditions statement in <i>Typical Characteristics</i> .	8
• Changed junction temperature range from $-40^{\circ}\text{C}$ to $125^{\circ}\text{C}$ to $-40^{\circ}\text{C}$ to $85^{\circ}\text{C}$ in <i>Overview</i> .	9
• Deleted TLV717xx functional block diagram	9

Changes from Original (October 2011) to Revision A	Page
• Changed document status from Product Preview to Production Data	1

## 5 Pin Configuration and Functions

**DQN Package  
4-Pin X2SON  
Top View**

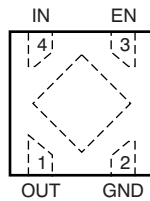

**DQN Package  
4-Pin X2SON  
Bottom View**

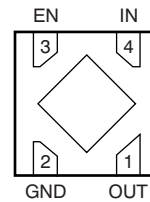

### Pin Functions

PIN		I/O	DESCRIPTION
NAME	NO.		
EN	3	I	Enable pin. Driving EN over 1.2 V turns on the regulator. Driving EN below 0.4 V puts the regulator into shutdown mode.
GND	2	—	Ground pin
IN	4	I	Input pin. A small capacitor is recommended from this pin to ground to assure stability. See the <a href="#">Input and Output Capacitor Requirements</a> section in the <a href="#">Application and Implementation</a> for more details.
OUT	1	O	Regulated output voltage pin. A small 1- $\mu$ F ceramic capacitor is recommended from this pin to ground to assure stability. See the <a href="#">Input and Output Capacitor Requirements</a> section in the <a href="#">Application and Implementation</a> for more details.
Thermal pad	—	—	Connect to GND for improved thermal performance.

## 6 Specifications

### 6.1 Absolute Maximum Ratings

At  $T_J = 25^\circ\text{C}$ , unless otherwise noted. All voltages are with respect to GND.<sup>(1)</sup>

		MIN	MAX	UNIT
Voltage	Input range, $V_{IN}$	-0.3	6	V
	Enable range, $V_{EN}$	-0.3	$V_{IN} + 0.3$	
	Output range, $V_{OUT}$	-0.3	6	
Current	Maximum output, $I_{OUT}$	Internally limited		
Output short-circuit duration		Indefinite		
Continuous total power dissipation, $P_{DISS}$		See <a href="#">Thermal Information</a>		
Temperature	Junction, $T_J$	-55	150	°C
	Storage junction, $T_{stg}$	-55	150	

(1) Stresses beyond those listed under *Absolute Maximum Ratings* may cause permanent damage to the device. These are stress ratings only, which do not imply functional operation of the device at these or any other conditions beyond those indicated under *Recommended Operating Conditions*. Exposure to absolute-maximum-rated conditions for extended periods may affect device reliability.

### 6.2 ESD Ratings

		VALUE	UNIT
$V_{(ESD)}$ Electrostatic discharge	Human-body model (HBM), per ANSI/ESDA/JEDEC JS-001 <sup>(1)</sup>	±2000	V
	Charged-device model (CDM), per JEDEC specification JESD22-C101 <sup>(2)</sup>	±500	

(1) JEDEC document JEP155 states that 500-V HBM allows safe manufacturing with a standard ESD control process.

(2) JEDEC document JEP157 states that 250-V CDM allows safe manufacturing with a standard ESD control process.

### 6.3 Recommended Operating Conditions

over operating junction temperature range (unless otherwise noted)

		MIN	MAX	UNIT
$V_{IN}$	Input voltage	1.7	5.5	V
$V_{OUT}$	Output voltage	1.2	5	V
$I_{OUT}$	Output current	0	150	mA
$V_{EN}$	Enable pin voltage	0	$V_{IN}$	V
$T_J$	Junction temperature	-40	85	°C

### 6.4 Thermal Information

THERMAL METRIC		TLV717P	UNIT
		DQN (X2SON)	
		4 PINS	
$R_{\theta JA}$	Junction-to-ambient thermal resistance	393.3	°C/W
$R_{\theta JC(top)}$	Junction-to-case(top) thermal resistance	140.3	°C/W
$R_{\theta JB}$	Junction-to-board thermal resistance	330	°C/W
$\Psi_{JT}$	Junction-to-top characterization parameter	6.5	°C/W
$\Psi_{JB}$	Junction-to-board characterization parameter	329	°C/W
$R_{\theta JC(bot)}$	Junction-to-case(bottom) thermal resistance	147.5	°C/W

## 6.5 Electrical Characteristics

At operating temperature range ( $T_J = -40^{\circ}\text{C}$  to  $85^{\circ}\text{C}$ ),  $T_J = 25^{\circ}\text{C}$ ,  $V_{IN} = V_{OUT(NOM)} + 0.5\text{ V}$  or  $1.7\text{ V}$  (whichever is greater),  $I_{OUT} = 10\text{ mA}$ ,  $V_{EN} = V_{IN}$ , and  $C_{OUT} = 1\text{ }\mu\text{F}$ , unless otherwise noted.

PARAMETER		TEST CONDITIONS	MIN	TYP	MAX	UNIT
$V_{IN}$	Input voltage range		1.7		5.5	V
$V_{OUT}$	Output voltage range		1.2		5	V
$I_{OUT}$	Output current		150			mA
	DC output accuracy	$T_J = +25^{\circ}\text{C}$	0.5%			
		$V_{OUT} \geq 1.2\text{ V}$ , $-40^{\circ}\text{C} \leq T_J \leq +85^{\circ}\text{C}$	-1.5%		1.5%	
		$V_{OUT} \leq 1.2\text{ V}$			25	mV
$\Delta V_O/V_{IN}$	Line regulation	$V_{OUT(NOM)} + 0.5\text{ V} \leq V_{IN} \leq 5.5\text{ V}$		1	5	mV
$\Delta V_O/I_{OUT}$	Load regulation	$0\text{ mA} \leq I_{OUT} \leq 150\text{ mA}$		10	20	mV
$V_{DO}$	Dropout voltage	$V_{IN} = 0.98 \times V_{OUT(NOM)}$ , $I_{OUT} = 150\text{ mA}$	$1.2\text{ V} \leq V_{OUT} < 1.5\text{ V}$	330	500	mV
			$1.5\text{ V} \leq V_{OUT} < 1.8\text{ V}$	330	450	
			$1.8\text{ V} \leq V_{OUT} \leq 5\text{ V}$	215	350	
$I_{GND}$	Ground pin current	$I_{OUT} = 0\text{ mA}$		35	55	$\mu\text{A}$
$I_{SHDN}$	Shutdown current	$V_{EN} \leq 0.4\text{ V}$ , $2\text{ V} \leq V_{IN} \leq 4.5\text{ V}$		0.1	0.5	$\mu\text{A}$
PSRR	Power-supply rejection ratio	$V_{IN} = 3.3\text{ V}$ , $V_{OUT} = 2.8\text{ V}$ , $I_{OUT} = 30\text{ mA}$	$f = 10\text{ Hz}$	70	dB	
			$f = 100\text{ Hz}$	70		
			$f = 1\text{ kHz}$	65		
			$f = 10\text{ kHz}$	60		
			$f = 100\text{ kHz}$	43		
$V_{NOISE}$	Output noise voltage	$BW = 100\text{ Hz to }100\text{ kHz}$ , $V_{IN} = 2.3\text{ V}$ , $V_{OUT} = 1.8\text{ V}$ , $I_{OUT} = 10\text{ mA}$		55		$\mu\text{V}_{RMS}$
$t_{STR}$	Start-up time	$C_{OUT} = 1\text{ }\mu\text{F}$ , $I_{OUT} = 150\text{ mA}$		100		$\mu\text{s}$
$I_{SC}$	Short current limit	$V_{IN} = \min(V_{OUT(NOM)} + 1\text{ V}, 5.5\text{ V})$ , $V_{OUT} = 0\text{ V}$		40		mA
$V_{HI}$	Enable high (enabled)		0.9		$V_{IN}$	V
$V_{LO}$	Enable low (disabled)		0		0.4	V
$I_{EN}$	EN pin current	$EN = 5.5\text{ V}$		0.01		$\mu\text{A}$
$R_{PULLDOWN}$	Pulldown resistor			120		$\Omega$
UVLO	Undervoltage lockout	$V_{IN}$ rising		1.6		V

### 6.6 Typical Characteristics

At operating temperature range ( $T_J = -40^{\circ}\text{C}$  to  $85^{\circ}\text{C}$ ),  $T_J = 25^{\circ}\text{C}$ ,  $V_{IN} = V_{OUT(NOM)} + 0.5\text{ V}$  or  $1.7\text{ V}$  (whichever is greater),  $I_{OUT} = 10\text{ mA}$ ,  $V_{EN} = V_{IN}$ , and  $C_{OUT} = 1\text{ }\mu\text{F}$ , unless otherwise noted.

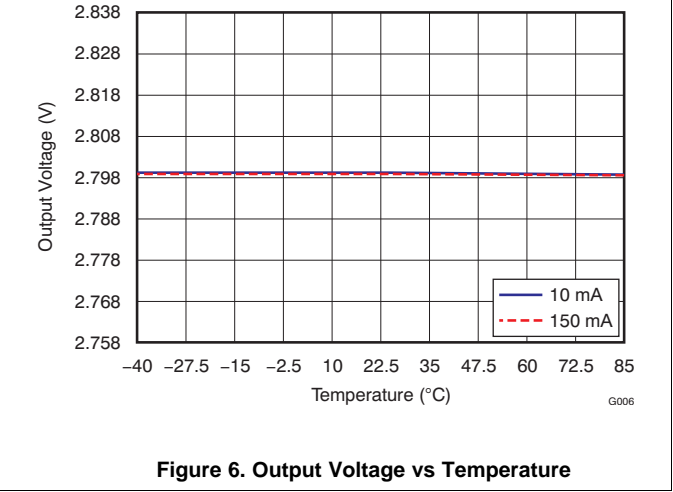
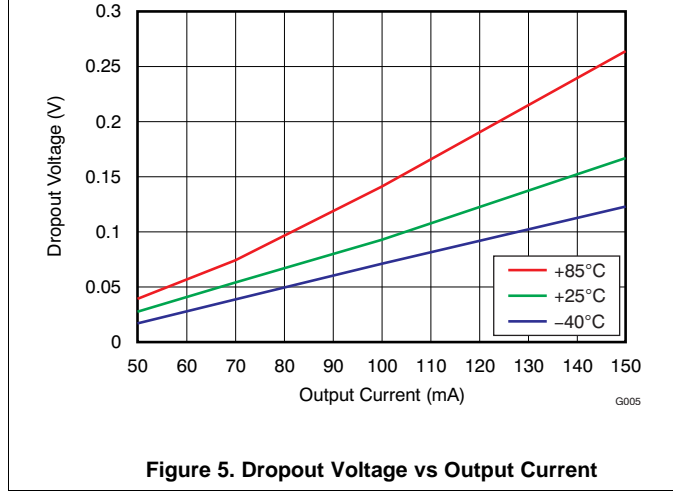
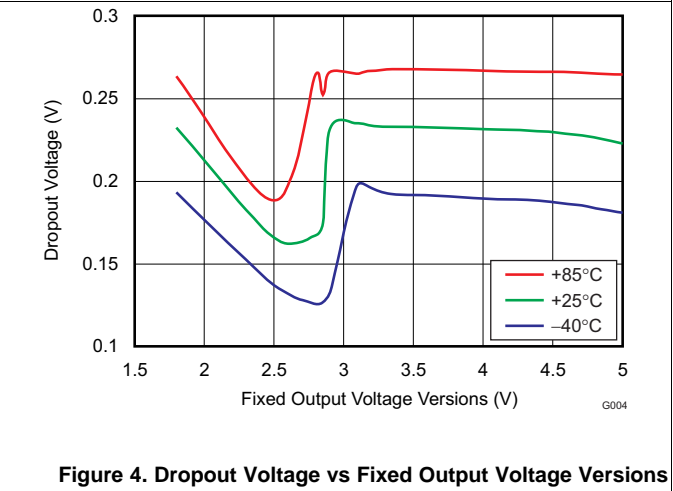
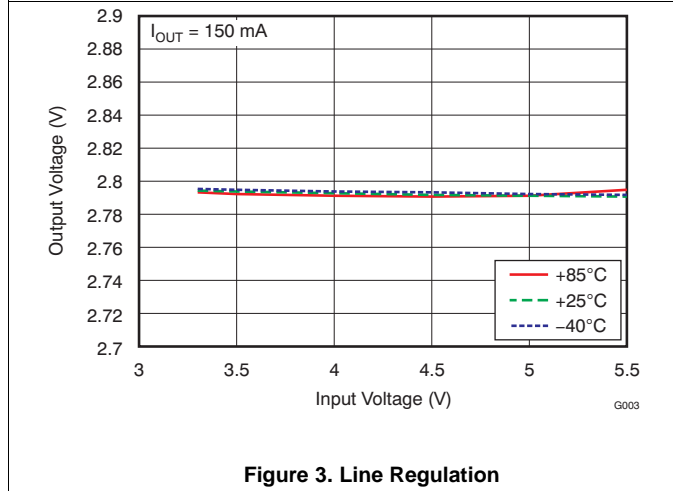
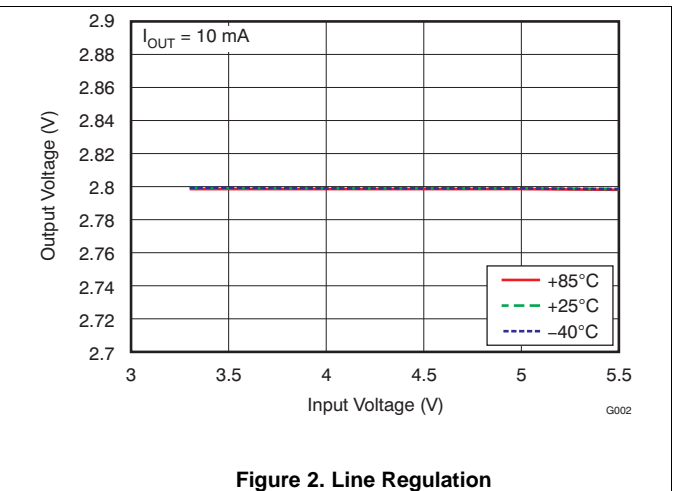
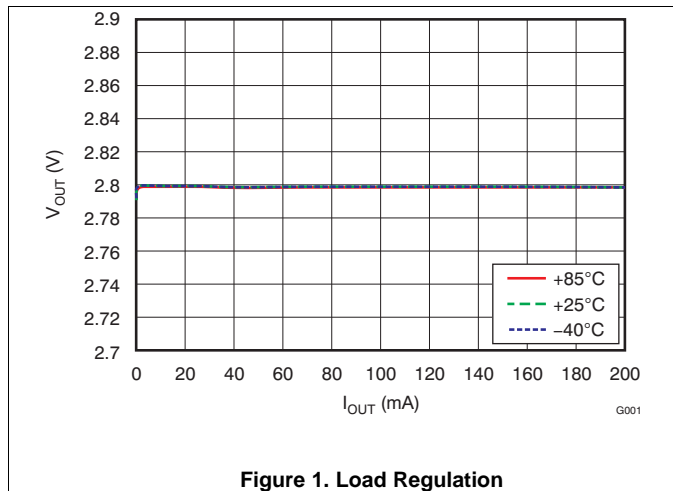

Typical Characteristics (continued)

At operating temperature range ( $T_J = -40^{\circ}\text{C}$  to  $85^{\circ}\text{C}$ ),  $T_J = 25^{\circ}\text{C}$ ,  $V_{IN} = V_{OUT(NOM)} + 0.5\text{ V}$  or  $1.7\text{ V}$  (whichever is greater),  $I_{OUT} = 10\text{ mA}$ ,  $V_{EN} = V_{IN}$ , and  $C_{OUT} = 1\text{ }\mu\text{F}$ , unless otherwise noted.

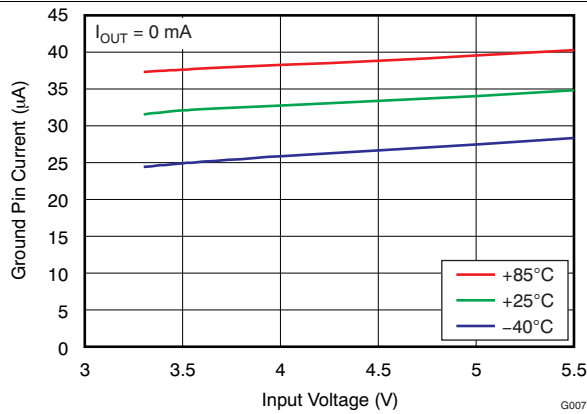

Figure 7. Ground Pin Current vs Input Voltage

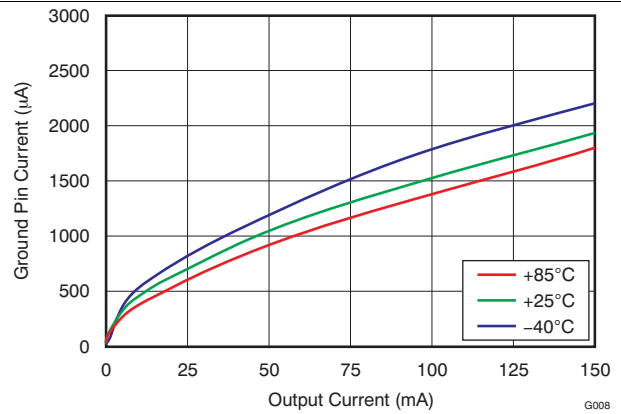

Figure 8. Ground Pin Current vs Output Current

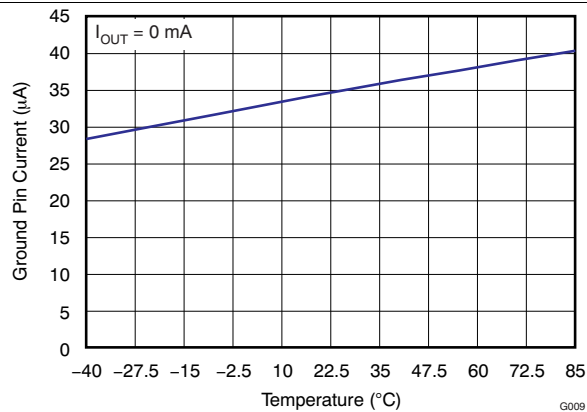

Figure 9. Ground Pin Current vs Temperature

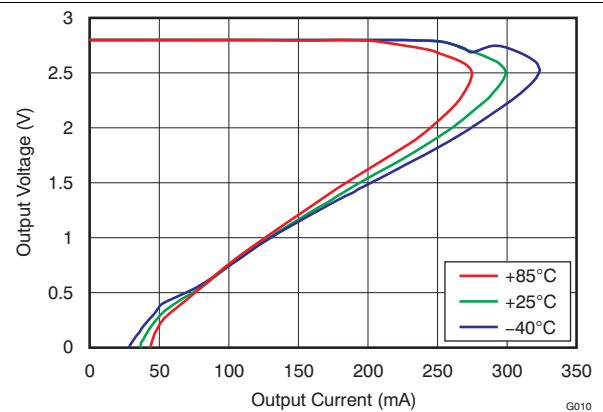

Figure 10. Output Voltage vs Output Current

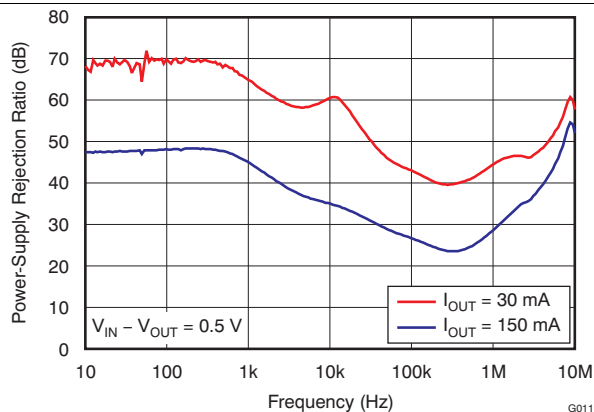

Figure 11. TLV71728PSRR vs Frequency

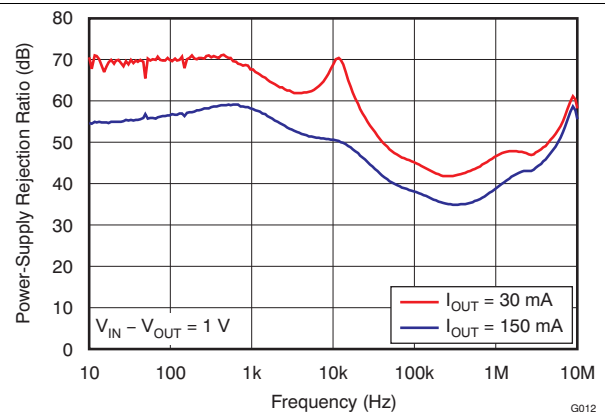

Figure 12. TLV71728PSRR vs Frequency

### Typical Characteristics (continued)

At operating temperature range ( $T_J = -40^{\circ}\text{C}$  to  $85^{\circ}\text{C}$ ),  $T_J = 25^{\circ}\text{C}$ ,  $V_{IN} = V_{OUT(NOM)} + 0.5\text{ V}$  or  $1.7\text{ V}$  (whichever is greater),  $I_{OUT} = 10\text{ mA}$ ,  $V_{EN} = V_{IN}$ , and  $C_{OUT} = 1\text{ }\mu\text{F}$ , unless otherwise noted.

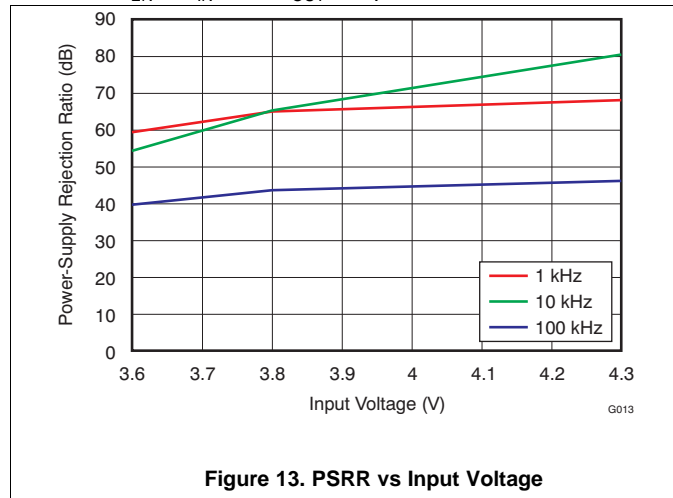

Figure 13. PSRR vs Input Voltage

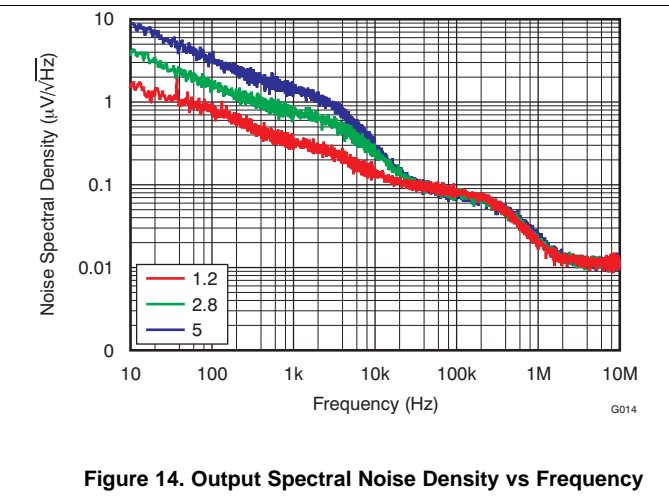

Figure 14. Output Spectral Noise Density vs Frequency



## 7 Detailed Description

### 7.1 Overview

The TLV717P belongs to a new family of next-generation value low-dropout (LDO) regulators. These devices consume low quiescent current and deliver excellent line and load transient performance. These characteristics, combined with low noise, very good PSRR with little ( $V_{IN} - V_{OUT}$ ) headroom, make this family of devices ideal for RF portable applications.

This family of regulators offers current foldback. Device operating junction temperature is  $-40^{\circ}\text{C}$  to  $85^{\circ}\text{C}$ .

### 7.2 Functional Block Diagram

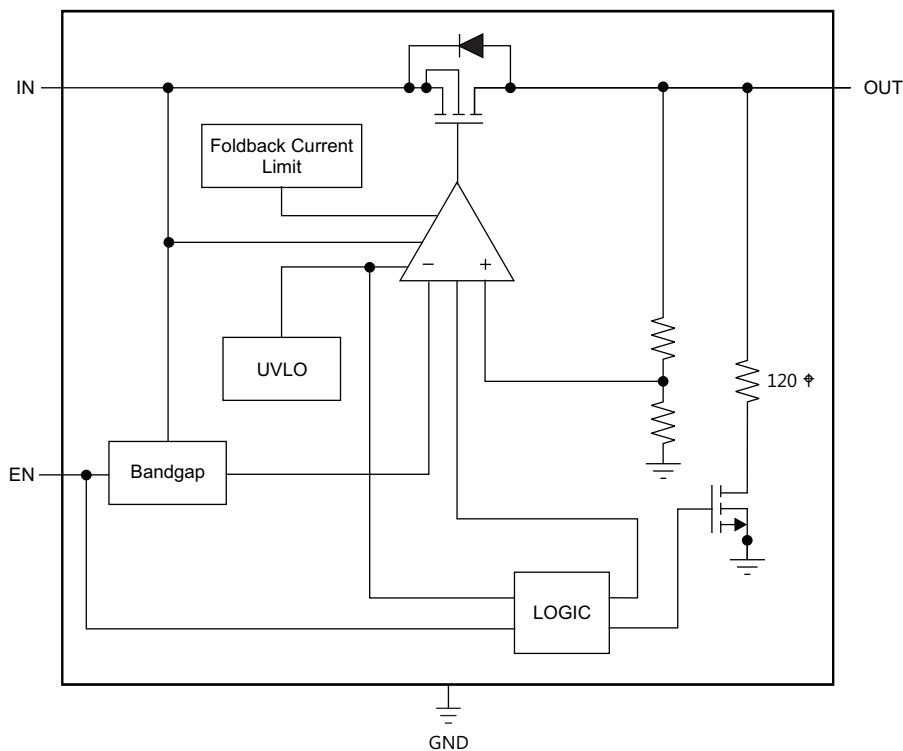

Copyright © 2016, Texas Instruments Incorporated

### 7.3 Feature Description

#### 7.3.1 Internal Current Limit

The TLV717P has an internal foldback current limit that helps to protect the regulator during fault conditions. The current supplied by the device is gradually throttled down as the output voltage decreases. When the output is shorted, the LDO supplies a typical current of 40 mA. Output voltage is not regulated when the device is in current limit, and is  $V_{OUT} = I_{LIMIT} \times R_{LOAD}$ . The advantage of foldback current limit is that the  $I_{LIMIT}$  value is less than the fixed current limit. Therefore, the power that the PMOS pass transistor dissipates [ $(V_{IN} - V_{OUT}) \times I_{LIMIT}$ ] is much less.

The TLV717P PMOS pass element has a built-in body diode that conducts current when the voltage at OUT exceeds the voltage at IN. This current is not limited, so if extended reverse voltage operation is anticipated, external limiting to 5% of the rated output current is recommended.

## Feature Description (continued)

### 7.3.2 Shutdown

The enable pin (EN) is active high. The device is enabled when the voltage at the EN pin goes above 0.9 V. This relatively lower voltage value required to turn the LDO on can be exploited to power the LDO with a GPIO of recent processors whose GPIO logic 1 voltage level is lower than traditional microcontrollers. The device is turned off when the EN pin is held at less than 0.4 V. When shutdown capability is not required, EN can be connected to the IN pin.

### 7.3.3 Undervoltage Lockout (UVLO)

The TLV717P uses an undervoltage lockout circuit (UVLO = 1.6 V) to keep the output shut off until the internal circuitry operates properly.

## 7.4 Device Functional Modes

### 7.4.1 Normal Operation

The device regulates to the nominal output voltage under the following conditions:

- The input voltage has previously exceeded the UVLO rising voltage and has not decreased below the UVLO falling threshold.
- The input voltage is greater than the nominal output voltage added to the dropout voltage.
- The enable voltage has previously exceeded the enable rising threshold voltage and not decreased below the enable falling threshold.
- The output current is less than the current limit.

### 7.4.2 Dropout Operation

If the input voltage is lower than the nominal output voltage plus the specified dropout voltage, but all other conditions are met for normal operation, the device operates in dropout mode. In this condition, the output voltage is the same the input voltage minus the dropout voltage. The transient performance of the device is significantly degraded because the pass device is in a triode state and no longer controls the current through the LDO. Line or load transients in dropout may result in large output voltage deviations.

### 7.4.3 Disabled

The device is disabled under the following conditions:

- The input voltage is less than the UVLO falling voltage, or has not yet exceeded the UVLO rising threshold.
- The enable voltage is less than the enable falling threshold voltage or has not yet exceeded the enable rising threshold.

When the device is disabled, the active pulldown resistor discharges the output.

[Table 1](#) lists the conditions that lead to the different modes of operation.

**Table 1. Device Functional Mode Comparison**

OPERATING MODE	PARAMETER		
	$V_{IN}$	$V_{EN}$	$I_{OUT}$
Normal mode	$V_{IN} > V_{OUT(nom)} + V_{DO}$ and $V_{IN} > UVLO_{RISE}$	$V_{EN} > V_{EN(HI)}$	$I_{OUT} < I_{LIM}$
Dropout mode	$UVLO_{RISE} < V_{IN} < V_{OUT(nom)} + V_{DO}$	$V_{EN} > V_{EN(HI)}$	$I_{OUT} < I_{LIM}$
Disabled mode (any true condition disables the device)	$V_{IN} < UVLO_{FALL}$	$V_{EN} < V_{EN(LO)}$	—

## 8 Application and Implementation

### NOTE

Information in the following applications sections is not part of the TI component specification, and TI does not warrant its accuracy or completeness. TI's customers are responsible for determining suitability of components for their purposes. Customers should validate and test their design implementation to confirm system functionality.

### 8.1 Application Information

The TLV717P is a low-dropout regulator (LDO) with low quiescent current that delivers excellent line and load transient performance. This LDO regulator offers a foldback current limit. The operating junction temperature of this device series is  $-40^{\circ}\text{C}$  to  $85^{\circ}\text{C}$ .

### 8.2 Typical Application

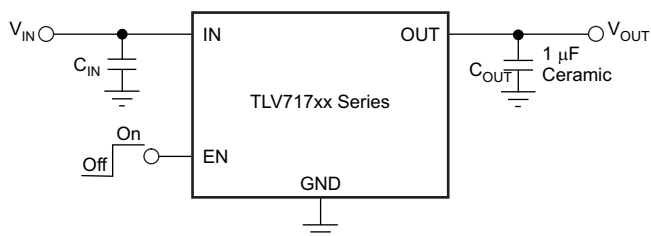

Copyright © 2016, Texas Instruments Incorporated

Figure 15. Typical Application Circuit

#### 8.2.1 Design Requirements

Table 2 lists the parameters for this application.

Table 2. Design Parameters

PARAMETER	DESIGN REQUIREMENT
Input voltage	3.8 V
Output voltage	2.8 V $\pm 1\%$
Output current	30 to 150 mA

#### 8.2.2 Detailed Design Procedure

##### 8.2.2.1 Input and Output Capacitor Requirements

TI recommends X5R- and X7R-type ceramic capacitors because they have minimal variation in value and equivalent series resistance (ESR) over temperature. The TLV717P is designed to be stable with an effective capacitance of  $0.1\ \mu\text{F}$  or larger at the output, though TI recommends a  $1\text{-}\mu\text{F}$  ceramic capacitor for typical applications. Thus, the device is stable with capacitors of other dielectric types as well, as long as the effective capacitance under operating bias voltage and temperature is greater than  $0.1\ \mu\text{F}$ . This effective capacitance refers to the capacitance that the LDO detects under operating bias voltage and temperature conditions; that is, the capacitance after taking both bias voltage and temperature derating into consideration. In addition to allowing the use of cheaper dielectrics, this capability of being stable with  $0.1\text{-}\mu\text{F}$  effective capacitance also enables the use of smaller footprint capacitors that have higher derating in size- and space-constrained applications. Using a  $0.1\text{-}\mu\text{F}$  rated capacitor at the LDO output does not ensure stability because the effective capacitance under the specified operating conditions would be less than  $0.1\ \mu\text{F}$ . Maximum ESR should be less than  $200\ \text{m}\Omega$ .

Although an input capacitor is not required for stability, it is good analog design practice to connect a  $0.1\text{-}\mu\text{F}$  to  $1\text{-}\mu\text{F}$ , low ESR capacitor across the IN and GND pins of the regulator. This capacitor counteracts reactive input sources and improves transient response, noise rejection, and ripple rejection. A higher-value capacitor may be necessary if large, fast, rise-time load transients are anticipated, or if the device is not located close to the power source. If source impedance is more than  $2\ \Omega$ , a  $0.1\text{-}\mu\text{F}$  input capacitor may be necessary to ensure stability.

### 8.2.2.2 Dropout Voltage

The TLV717P uses a PMOS pass transistor to achieve low dropout. When  $(V_{IN} - V_{OUT})$  is less than the dropout voltage ( $V_{DO}$ ), the PMOS pass device is in the linear region of operation and the input-to-output resistance is the  $R_{DS(ON)}$  of the PMOS pass element.  $V_{DO}$  scales approximately with output current because the PMOS device behaves like a resistor in dropout. As with any linear regulator, PSRR and transient response are degraded as  $(V_{IN} - V_{OUT})$  approaches dropout.

### 8.2.2.3 Transient Response

As with any regulator, increasing the size of the output capacitor reduces over- and undershoot magnitude but increases the duration of the transient response.

### 8.2.3 Application Curves

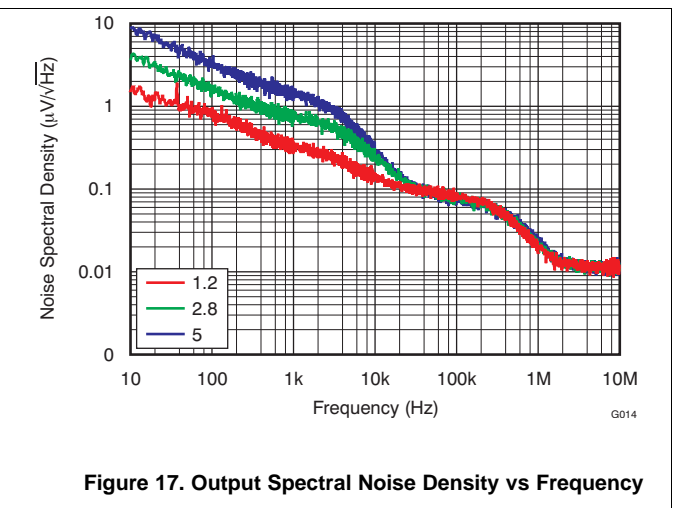
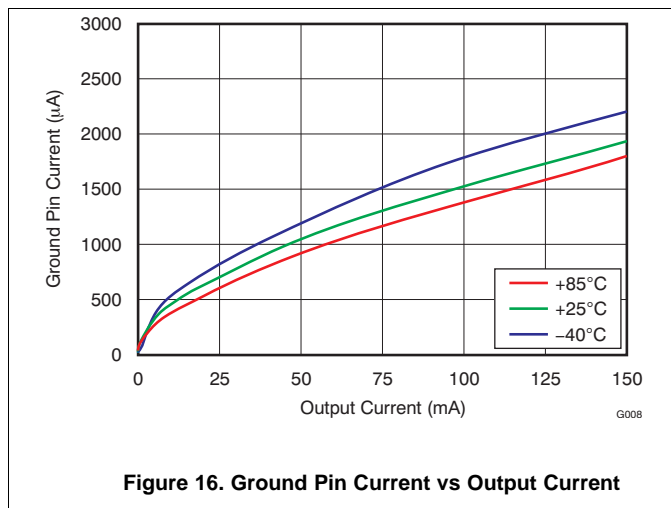

## 9 Power Supply Recommendations

Connect a low-output impedance power supply directly to the IN pin of the TLV717P. Inductive impedances between the input supply and the IN pin can create significant voltage excursions at the IN pin during start-up or load transient events. If inductive impedances are unavoidable, use an input capacitor.

## 10 Layout

### 10.1 Layout Guidelines

Input and output capacitors should be placed as close to the device pins as possible. To improve AC performance (such as PSRR, output noise, and transient response), TI recommends designing the board with separate ground planes for  $V_{IN}$  and  $V_{OUT}$ , with the ground plane connected only at the device GND pin. In addition, the output capacitor ground connection should be connected directly to the device GND pin. High ESR capacitors may degrade PSRR performance.

### 10.2 Layout Example

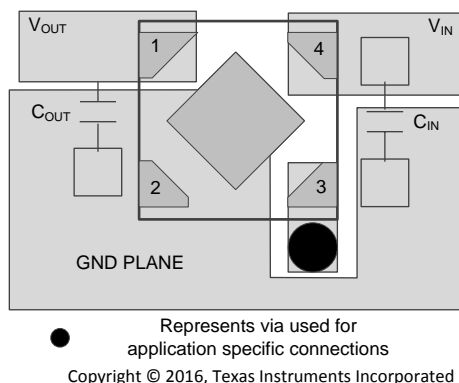

Figure 18. Recommended Layout Example

### 10.3 Power Dissipation

The ability to remove heat from the die is different for each package type, presenting different considerations in the printed-circuit board (PCB) layout. The PCB area around the device that is free of other components moves the heat from the device to ambient air. Performance data for JEDEC-low and high-K boards are given in [Thermal Information](#). Using heavier copper increases the effectiveness in removing heat from the device. The addition, plated through-holes to heat-dissipating layers also improves heatsink effectiveness.

Power dissipation depends on input voltage and load conditions. Power dissipation ( $P_D$ ) is equal to the product of the output current and the voltage drop across the output pass element, as shown in [Equation 1](#).

$$P_D = (V_{IN} - V_{OUT}) \times I_{OUT} \quad (1)$$

## 11 Device and Documentation Support

### 11.1 Device Support

#### 11.1.1 Development Support

##### 11.1.1.1 Evaluation Modules

An evaluation module (EVM) is available to assist in the initial circuit performance evaluation using the TLV717P. [SLVU553](#) details the design kits and evaluation modules for [TLV71733PEVM-072](#).

The EVM can be requested at the Texas Instruments website through the [TLV717P](#) product folder, or purchased directly from the [TI eStore](#).

#### 11.1.2 Device Nomenclature

**Table 3. Device Nomenclature<sup>(1)</sup>**

PRODUCT	V <sub>OUT</sub>
TLV717xx(x)Pyyyz	<p><b>XX(X)</b> is the nominal output voltage. For output voltages with a resolution of 100 mV, two digits are used in the ordering number; otherwise, three digits are used (for example, 28 = 2.8 V; 475 = 4.75 V).</p> <p><b>P</b> indicates an active output discharge feature. All members of TLV717P family will actively discharge the output when the device is disabled.</p> <p><b>YYY</b> is the package designator.</p> <p><b>Z</b> is the package quantity. R is for 3000 pieces, T is for 250 pieces.</p>

(1) For the most current package and ordering information see the Package Option Addendum at the end of this document, or visit the device product folder on [www.ti.com](http://www.ti.com).

## 11.2 Documentation Support

### 11.2.1 Related Documentation

[TLV71733PEVM-072 Evaluation Module user guide](#), [SLVU553](#)

## 11.3 Community Resource

The following links connect to TI community resources. Linked contents are provided "AS IS" by the respective contributors. They do not constitute TI specifications and do not necessarily reflect TI's views; see TI's [Terms of Use](#).

**TI E2E™ Online Community** *TI's Engineer-to-Engineer (E2E) Community*. Created to foster collaboration among engineers. At [e2e.ti.com](http://e2e.ti.com), you can ask questions, share knowledge, explore ideas and help solve problems with fellow engineers.

**Design Support** *TI's Design Support* Quickly find helpful E2E forums along with design support tools and contact information for technical support.

## 11.4 Trademarks

E2E is a trademark of Texas Instruments.

All other trademarks are the property of their respective owners.

## 11.5 Electrostatic Discharge Caution



This integrated circuit can be damaged by ESD. Texas Instruments recommends that all integrated circuits be handled with appropriate precautions. Failure to observe proper handling and installation procedures can cause damage.

ESD damage can range from subtle performance degradation to complete device failure. Precision integrated circuits may be more susceptible to damage because very small parametric changes could cause the device not to meet its published specifications.

## 11.6 Glossary

[SLYZ022](#) — *TI Glossary*.

This glossary lists and explains terms, acronyms, and definitions.

## 12 Mechanical, Packaging, and Orderable Information

The following pages include mechanical, packaging, and orderable information. This information is the most current data available for the designated devices. This data is subject to change without notice and revision of this document. For browser-based versions of this data sheet, refer to the left-hand navigation.

**PACKAGING INFORMATION**

Orderable Device	Status (1)	Package Type	Package Drawing	Pins	Package Qty	Eco Plan (2)	Lead/Ball Finish (6)	MSL Peak Temp (3)	Op Temp (°C)	Device Marking (4/5)	Samples
TLV71712PDQNR	ACTIVE	X2SON	DQN	4	3000	Green (RoHS & no Sb/Br)	CU NIPDAU	Level-1-260C-UNLIM	-40 to 85	UX	<a href="#">Samples</a>
TLV71712PDQNR3	ACTIVE	X2SON	DQN	4	3000	Green (RoHS & no Sb/Br)	CU NIPDAU	Level-1-260C-UNLIM	-40 to 85	UX	<a href="#">Samples</a>
TLV71712PDQNT	ACTIVE	X2SON	DQN	4	250	Green (RoHS & no Sb/Br)	CU NIPDAU	Level-1-260C-UNLIM	-40 to 85	UX	<a href="#">Samples</a>
TLV71713PDQNR	ACTIVE	X2SON	DQN	4	3000	Green (RoHS & no Sb/Br)	CU NIPDAU	Level-1-260C-UNLIM	-40 to 85	VC	<a href="#">Samples</a>
TLV71713PDQNT	ACTIVE	X2SON	DQN	4	250	Green (RoHS & no Sb/Br)	CU NIPDAU	Level-1-260C-UNLIM	-40 to 85	VC	<a href="#">Samples</a>
TLV71715PDQNR	ACTIVE	X2SON	DQN	4	3000	Green (RoHS & no Sb/Br)	CU NIPDAU	Level-1-260C-UNLIM	-40 to 85	UY	<a href="#">Samples</a>
TLV71715PDQNT	ACTIVE	X2SON	DQN	4	250	Green (RoHS & no Sb/Br)	CU NIPDAU	Level-1-260C-UNLIM	-40 to 85	UY	<a href="#">Samples</a>
TLV717185PDQNR	ACTIVE	X2SON	DQN	4	3000	Green (RoHS & no Sb/Br)	CU NIPDAU	Level-1-260C-UNLIM	-40 to 85	VN	<a href="#">Samples</a>
TLV717185PDQNT	ACTIVE	X2SON	DQN	4	250	Green (RoHS & no Sb/Br)	CU NIPDAU	Level-1-260C-UNLIM	-40 to 85	VN	<a href="#">Samples</a>
TLV71718PDQNR	ACTIVE	X2SON	DQN	4	3000	Green (RoHS & no Sb/Br)	CU NIPDAU	Level-1-260C-UNLIM	-40 to 85	UZ	<a href="#">Samples</a>
TLV71718PDQNT	ACTIVE	X2SON	DQN	4	250	Green (RoHS & no Sb/Br)	CU NIPDAU	Level-1-260C-UNLIM	-40 to 85	UZ	<a href="#">Samples</a>
TLV71721PDQNR	ACTIVE	X2SON	DQN	4	3000	Green (RoHS & no Sb/Br)	CU NIPDAU	Level-1-260C-UNLIM	-40 to 85	AR	<a href="#">Samples</a>
TLV71721PDQNT	ACTIVE	X2SON	DQN	4	250	Green (RoHS & no Sb/Br)	CU NIPDAU	Level-1-260C-UNLIM	-40 to 85	AR	<a href="#">Samples</a>
TLV71725PDQNR	ACTIVE	X2SON	DQN	4	3000	Green (RoHS & no Sb/Br)	CU NIPDAU	Level-1-260C-UNLIM	-40 to 85	VA	<a href="#">Samples</a>
TLV71725PDQNT	ACTIVE	X2SON	DQN	4	250	Green (RoHS & no Sb/Br)	CU NIPDAU	Level-1-260C-UNLIM	-40 to 85	VA	<a href="#">Samples</a>
TLV71727PDQNR	ACTIVE	X2SON	DQN	4	3000	Green (RoHS & no Sb/Br)	CU NIPDAU	Level-1-260C-UNLIM	-40 to 85	AS	<a href="#">Samples</a>
TLV71727PDQNT	ACTIVE	X2SON	DQN	4	250	Green (RoHS & no Sb/Br)	CU NIPDAU	Level-1-260C-UNLIM	-40 to 85	AS	<a href="#">Samples</a>



Orderable Device	Status (1)	Package Type	Package Drawing	Pins	Package Qty	Eco Plan (2)	Lead/Ball Finish (6)	MSL Peak Temp (3)	Op Temp (°C)	Device Marking (4/5)	Samples
TLV717285PDQNR	ACTIVE	X2SON	DQN	4	3000	Green (RoHS & no Sb/Br)	CU NIPDAU	Level-1-260C-UNLIM		VE	<a href="#">Samples</a>
TLV717285PDQNT	ACTIVE	X2SON	DQN	4	250	Green (RoHS & no Sb/Br)	CU NIPDAU	Level-1-260C-UNLIM	-40 to 85	VE	<a href="#">Samples</a>
TLV71728PDQNR	ACTIVE	X2SON	DQN	4	3000	Green (RoHS & no Sb/Br)	CU NIPDAU	Level-1-260C-UNLIM	-40 to 85	VD	<a href="#">Samples</a>
TLV71728PDQNR3	ACTIVE	X2SON	DQN	4	3000	Green (RoHS & no Sb/Br)	CU NIPDAU	Level-1-260C-UNLIM	-40 to 85	VD	<a href="#">Samples</a>
TLV71728PDQNT	ACTIVE	X2SON	DQN	4	250	Green (RoHS & no Sb/Br)	CU NIPDAU	Level-1-260C-UNLIM	-40 to 85	VD	<a href="#">Samples</a>
TLV71729PDQNR	ACTIVE	X2SON	DQN	4	3000	Green (RoHS & no Sb/Br)	CU NIPDAU	Level-1-260C-UNLIM	-40 to 85	VI	<a href="#">Samples</a>
TLV71729PDQNT	ACTIVE	X2SON	DQN	4	250	Green (RoHS & no Sb/Br)	CU NIPDAU	Level-1-260C-UNLIM	-40 to 85	VI	<a href="#">Samples</a>
TLV71730PDQNR	ACTIVE	X2SON	DQN	4	3000	Green (RoHS & no Sb/Br)	CU NIPDAU	Level-1-260C-UNLIM	-40 to 85	VF	<a href="#">Samples</a>
TLV71730PDQNT	ACTIVE	X2SON	DQN	4	250	Green (RoHS & no Sb/Br)	CU NIPDAU	Level-1-260C-UNLIM	-40 to 85	VF	<a href="#">Samples</a>
TLV71733PDQNR	ACTIVE	X2SON	DQN	4	3000	Green (RoHS & no Sb/Br)	CU NIPDAU	Level-1-260C-UNLIM	-40 to 85	VG	<a href="#">Samples</a>
TLV71733PDQNT	ACTIVE	X2SON	DQN	4	250	Green (RoHS & no Sb/Br)	CU NIPDAU	Level-1-260C-UNLIM	-40 to 85	VG	<a href="#">Samples</a>
TLV71736PDQNR	ACTIVE	X2SON	DQN	4	3000	Green (RoHS & no Sb/Br)	CU NIPDAU	Level-1-260C-UNLIM	-40 to 85	VH	<a href="#">Samples</a>
TLV71736PDQNT	ACTIVE	X2SON	DQN	4	250	Green (RoHS & no Sb/Br)	CU NIPDAU	Level-1-260C-UNLIM	-40 to 85	VH	<a href="#">Samples</a>

(1) The marketing status values are defined as follows:

**ACTIVE:** Product device recommended for new designs.

**LIFEBUY:** TI has announced that the device will be discontinued, and a lifetime-buy period is in effect.

**NRND:** Not recommended for new designs. Device is in production to support existing customers, but TI does not recommend using this part in a new design.

**PREVIEW:** Device has been announced but is not in production. Samples may or may not be available.

**OBSELETE:** TI has discontinued the production of the device.

(2) Eco Plan - The planned eco-friendly classification: Pb-Free (RoHS), Pb-Free (RoHS Exempt), or Green (RoHS & no Sb/Br) - please check <http://www.ti.com/productcontent> for the latest availability information and additional product content details.

**TBD:** The Pb-Free/Green conversion plan has not been defined.

---

**Pb-Free (RoHS):** TI's terms "Lead-Free" or "Pb-Free" mean semiconductor products that are compatible with the current RoHS requirements for all 6 substances, including the requirement that lead not exceed 0.1% by weight in homogeneous materials. Where designed to be soldered at high temperatures, TI Pb-Free products are suitable for use in specified lead-free processes.

**Pb-Free (RoHS Exempt):** This component has a RoHS exemption for either 1) lead-based flip-chip solder bumps used between the die and package, or 2) lead-based die adhesive used between the die and leadframe. The component is otherwise considered Pb-Free (RoHS compatible) as defined above.

**Green (RoHS & no Sb/Br):** TI defines "Green" to mean Pb-Free (RoHS compatible), and free of Bromine (Br) and Antimony (Sb) based flame retardants (Br or Sb do not exceed 0.1% by weight in homogeneous material)

<sup>(3)</sup> MSL, Peak Temp. - The Moisture Sensitivity Level rating according to the JEDEC industry standard classifications, and peak solder temperature.

<sup>(4)</sup> There may be additional marking, which relates to the logo, the lot trace code information, or the environmental category on the device.

<sup>(5)</sup> Multiple Device Markings will be inside parentheses. Only one Device Marking contained in parentheses and separated by a "~" will appear on a device. If a line is indented then it is a continuation of the previous line and the two combined represent the entire Device Marking for that device.

<sup>(6)</sup> Lead/Ball Finish - Orderable Devices may have multiple material finish options. Finish options are separated by a vertical ruled line. Lead/Ball Finish values may wrap to two lines if the finish value exceeds the maximum column width.

**Important Information and Disclaimer:**The information provided on this page represents TI's knowledge and belief as of the date that it is provided. TI bases its knowledge and belief on information provided by third parties, and makes no representation or warranty as to the accuracy of such information. Efforts are underway to better integrate information from third parties. TI has taken and continues to take reasonable steps to provide representative and accurate information but may not have conducted destructive testing or chemical analysis on incoming materials and chemicals. TI and TI suppliers consider certain information to be proprietary, and thus CAS numbers and other limited information may not be available for release.

In no event shall TI's liability arising out of such information exceed the total purchase price of the TI part(s) at issue in this document sold by TI to Customer on an annual basis.

**TAPE AND REEL INFORMATION**

**QUADRANT ASSIGNMENTS FOR PIN 1 ORIENTATION IN TAPE**

\*All dimensions are nominal

Device	Package Type	Package Drawing	Pins	SPQ	Reel Diameter (mm)	Reel Width W1 (mm)	A0 (mm)	B0 (mm)	K0 (mm)	P1 (mm)	W (mm)	Pin1 Quadrant
TLV71712PDQNR	X2SON	DQN	4	3000	180.0	9.5	1.16	1.16	0.5	4.0	8.0	Q2
TLV71712PDQNR	X2SON	DQN	4	3000	180.0	8.4	1.16	1.16	0.63	4.0	8.0	Q2
TLV71712PDQNR3	X2SON	DQN	4	3000	180.0	9.5	1.16	1.16	0.5	2.0	8.0	Q3
TLV71712PDQNT	X2SON	DQN	4	250	180.0	8.4	1.16	1.16	0.63	4.0	8.0	Q2
TLV71712PDQNT	X2SON	DQN	4	250	180.0	9.5	1.16	1.16	0.5	4.0	8.0	Q2
TLV71713PDQNR	X2SON	DQN	4	3000	180.0	9.5	1.16	1.16	0.5	4.0	8.0	Q2
TLV71713PDQNR	X2SON	DQN	4	3000	180.0	8.4	1.16	1.16	0.63	4.0	8.0	Q2
TLV71713PDQNT	X2SON	DQN	4	250	180.0	9.5	1.16	1.16	0.5	4.0	8.0	Q2
TLV71713PDQNT	X2SON	DQN	4	250	180.0	8.4	1.16	1.16	0.63	4.0	8.0	Q2
TLV71715PDQNR	X2SON	DQN	4	3000	180.0	9.5	1.16	1.16	0.5	4.0	8.0	Q2
TLV71715PDQNR	X2SON	DQN	4	3000	180.0	8.4	1.16	1.16	0.63	4.0	8.0	Q2
TLV71715PDQNT	X2SON	DQN	4	250	180.0	8.4	1.16	1.16	0.63	4.0	8.0	Q2
TLV71715PDQNT	X2SON	DQN	4	250	180.0	9.5	1.16	1.16	0.5	4.0	8.0	Q2
TLV71721PDQNR	X2SON	DQN	4	3000	180.0	9.5	1.16	1.16	0.5	4.0	8.0	Q2
TLV71721PDQNR	X2SON	DQN	4	3000	180.0	8.4	1.16	1.16	0.63	4.0	8.0	Q2
TLV71721PDQNT	X2SON	DQN	4	250	180.0	9.5	1.16	1.16	0.5	4.0	8.0	Q2
TLV71721PDQNT	X2SON	DQN	4	250	180.0	8.4	1.16	1.16	0.63	4.0	8.0	Q2
TLV71725PDQNR	X2SON	DQN	4	3000	180.0	9.5	1.16	1.16	0.5	4.0	8.0	Q2

Device	Package Type	Package Drawing	Pins	SPQ	Reel Diameter (mm)	Reel Width W1 (mm)	A0 (mm)	B0 (mm)	K0 (mm)	P1 (mm)	W (mm)	Pin1 Quadrant
TLV71725PDQNR	X2SON	DQN	4	3000	180.0	8.4	1.16	1.16	0.63	4.0	8.0	Q2
TLV71725PDQNT	X2SON	DQN	4	250	180.0	8.4	1.16	1.16	0.63	4.0	8.0	Q2
TLV71725PDQNT	X2SON	DQN	4	250	180.0	9.5	1.16	1.16	0.5	4.0	8.0	Q2
TLV717285PDQNR	X2SON	DQN	4	3000	180.0	9.5	1.16	1.16	0.5	4.0	8.0	Q2
TLV717285PDQNR	X2SON	DQN	4	3000	180.0	8.4	1.16	1.16	0.63	4.0	8.0	Q2
TLV717285PDQNT	X2SON	DQN	4	250	180.0	9.5	1.16	1.16	0.5	4.0	8.0	Q2
TLV717285PDQNT	X2SON	DQN	4	250	180.0	8.4	1.16	1.16	0.63	4.0	8.0	Q2
TLV71728PDQNR	X2SON	DQN	4	3000	180.0	9.5	1.16	1.16	0.5	4.0	8.0	Q2
TLV71728PDQNR	X2SON	DQN	4	3000	180.0	8.4	1.16	1.16	0.63	4.0	8.0	Q2
TLV71728PDQNR3	X2SON	DQN	4	3000	180.0	9.5	1.16	1.16	0.5	2.0	8.0	Q3
TLV71728PDQNT	X2SON	DQN	4	250	180.0	8.4	1.16	1.16	0.63	4.0	8.0	Q2
TLV71728PDQNT	X2SON	DQN	4	250	180.0	9.5	1.16	1.16	0.5	4.0	8.0	Q2
TLV71730PDQNR	X2SON	DQN	4	3000	180.0	8.4	1.16	1.16	0.63	4.0	8.0	Q2
TLV71730PDQNR	X2SON	DQN	4	3000	180.0	9.5	1.16	1.16	0.5	4.0	8.0	Q2
TLV71730PDQNT	X2SON	DQN	4	250	180.0	8.4	1.16	1.16	0.63	4.0	8.0	Q2
TLV71730PDQNT	X2SON	DQN	4	250	180.0	9.5	1.16	1.16	0.5	4.0	8.0	Q2
TLV71733PDQNR	X2SON	DQN	4	3000	180.0	9.5	1.16	1.16	0.5	4.0	8.0	Q2
TLV71736PDQNR	X2SON	DQN	4	3000	180.0	9.5	1.16	1.16	0.5	4.0	8.0	Q2
TLV71736PDQNR	X2SON	DQN	4	3000	180.0	8.4	1.16	1.16	0.63	4.0	8.0	Q2
TLV71736PDQNT	X2SON	DQN	4	250	180.0	9.5	1.16	1.16	0.5	4.0	8.0	Q2
TLV71736PDQNT	X2SON	DQN	4	250	180.0	8.4	1.16	1.16	0.63	4.0	8.0	Q2

**TAPE AND REEL BOX DIMENSIONS**

\*All dimensions are nominal

Device	Package Type	Package Drawing	Pins	SPQ	Length (mm)	Width (mm)	Height (mm)
TLV71712PDQNR	X2SON	DQN	4	3000	184.0	184.0	19.0
TLV71712PDQNR	X2SON	DQN	4	3000	202.0	201.0	28.0
TLV71712PDQNR3	X2SON	DQN	4	3000	184.0	184.0	19.0
TLV71712PDQNT	X2SON	DQN	4	250	202.0	201.0	28.0
TLV71712PDQNT	X2SON	DQN	4	250	184.0	184.0	19.0
TLV71713PDQNR	X2SON	DQN	4	3000	184.0	184.0	19.0
TLV71713PDQNR	X2SON	DQN	4	3000	202.0	201.0	28.0
TLV71713PDQNT	X2SON	DQN	4	250	184.0	184.0	19.0
TLV71713PDQNT	X2SON	DQN	4	250	202.0	201.0	28.0
TLV71715PDQNR	X2SON	DQN	4	3000	184.0	184.0	19.0
TLV71715PDQNR	X2SON	DQN	4	3000	202.0	201.0	28.0
TLV71715PDQNT	X2SON	DQN	4	250	202.0	201.0	28.0
TLV71715PDQNT	X2SON	DQN	4	250	184.0	184.0	19.0
TLV71721PDQNR	X2SON	DQN	4	3000	184.0	184.0	19.0
TLV71721PDQNR	X2SON	DQN	4	3000	202.0	201.0	28.0
TLV71721PDQNT	X2SON	DQN	4	250	184.0	184.0	19.0
TLV71721PDQNT	X2SON	DQN	4	250	202.0	201.0	28.0
TLV71725PDQNR	X2SON	DQN	4	3000	184.0	184.0	19.0
TLV71725PDQNR	X2SON	DQN	4	3000	202.0	201.0	28.0
TLV71725PDQNT	X2SON	DQN	4	250	202.0	201.0	28.0

Device	Package Type	Package Drawing	Pins	SPQ	Length (mm)	Width (mm)	Height (mm)
TLV71725PDQNT	X2SON	DQN	4	250	184.0	184.0	19.0
TLV717285PDQNR	X2SON	DQN	4	3000	184.0	184.0	19.0
TLV717285PDQNR	X2SON	DQN	4	3000	202.0	201.0	28.0
TLV717285PDQNT	X2SON	DQN	4	250	184.0	184.0	19.0
TLV717285PDQNT	X2SON	DQN	4	250	202.0	201.0	28.0
TLV71728PDQNR	X2SON	DQN	4	3000	184.0	184.0	19.0
TLV71728PDQNR	X2SON	DQN	4	3000	202.0	201.0	28.0
TLV71728PDQNR3	X2SON	DQN	4	3000	184.0	184.0	19.0
TLV71728PDQNT	X2SON	DQN	4	250	202.0	201.0	28.0
TLV71728PDQNT	X2SON	DQN	4	250	184.0	184.0	19.0
TLV71730PDQNR	X2SON	DQN	4	3000	202.0	201.0	28.0
TLV71730PDQNR	X2SON	DQN	4	3000	184.0	184.0	19.0
TLV71730PDQNT	X2SON	DQN	4	250	202.0	201.0	28.0
TLV71730PDQNT	X2SON	DQN	4	250	184.0	184.0	19.0
TLV71733PDQNR	X2SON	DQN	4	3000	184.0	184.0	19.0
TLV71736PDQNR	X2SON	DQN	4	3000	184.0	184.0	19.0
TLV71736PDQNR	X2SON	DQN	4	3000	202.0	201.0	28.0
TLV71736PDQNT	X2SON	DQN	4	250	184.0	184.0	19.0
TLV71736PDQNT	X2SON	DQN	4	250	202.0	201.0	28.0

## GENERIC PACKAGE VIEW

DQN 4

**X2SON - 0.4 mm max height**

PLASTIC SMALL OUTLINE - NO LEAD



Images above are just a representation of the package family, actual package may vary.  
Refer to the product data sheet for package details.

4210367/F

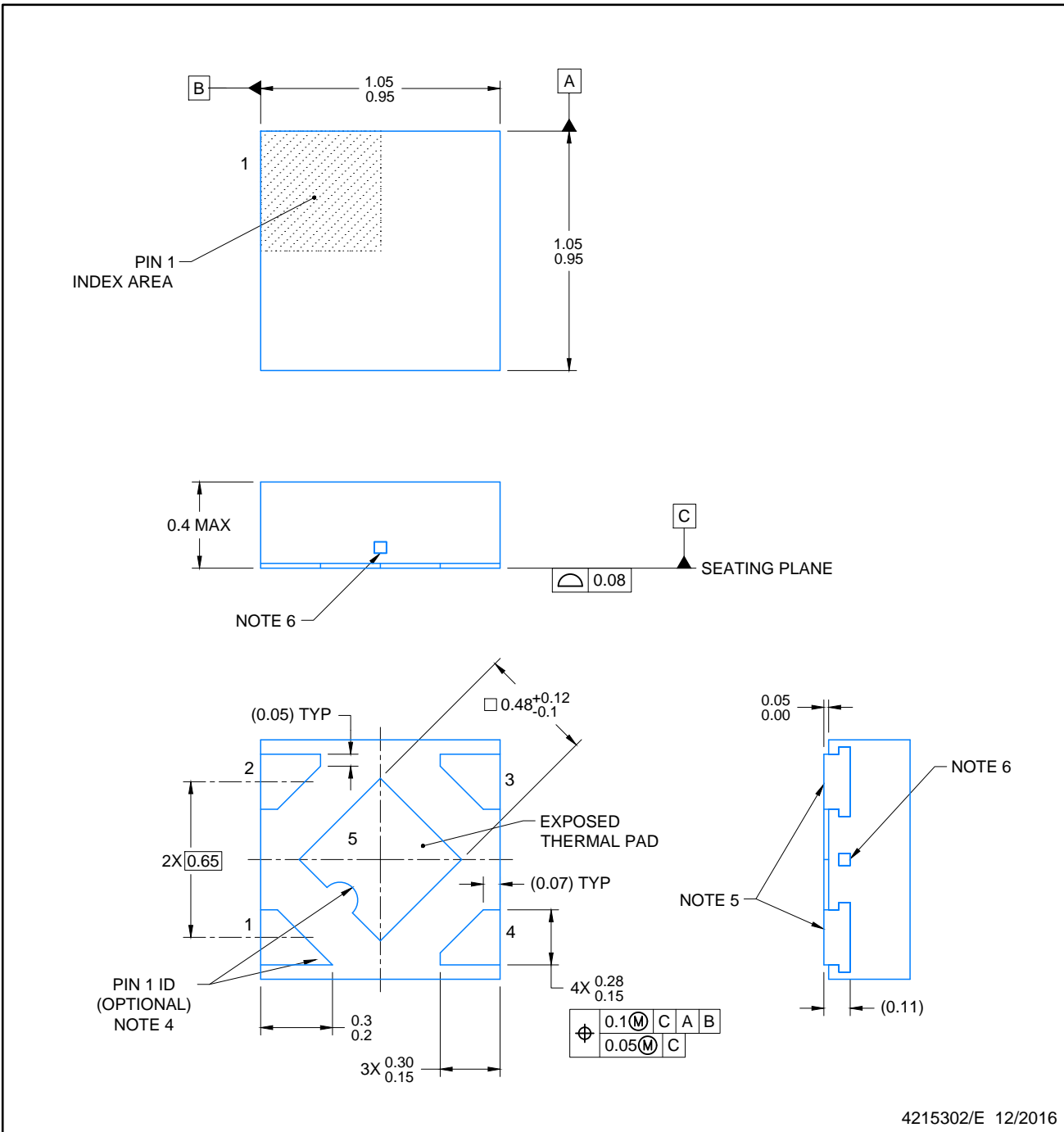

4215302/E 12/2016

NOTES:

1. All linear dimensions are in millimeters. Any dimensions in parenthesis are for reference only. Dimensioning and tolerancing per ASME Y14.5M.
2. This drawing is subject to change without notice.
3. The package thermal pad must be soldered to the printed circuit board for optimal thermal and mechanical performance.
4. Features may not exist. Recommend use of pin 1 marking on top of package for orientation purposes.
5. Shape of exposed side leads may differ.
6. Number and location of exposed tie bars may vary.



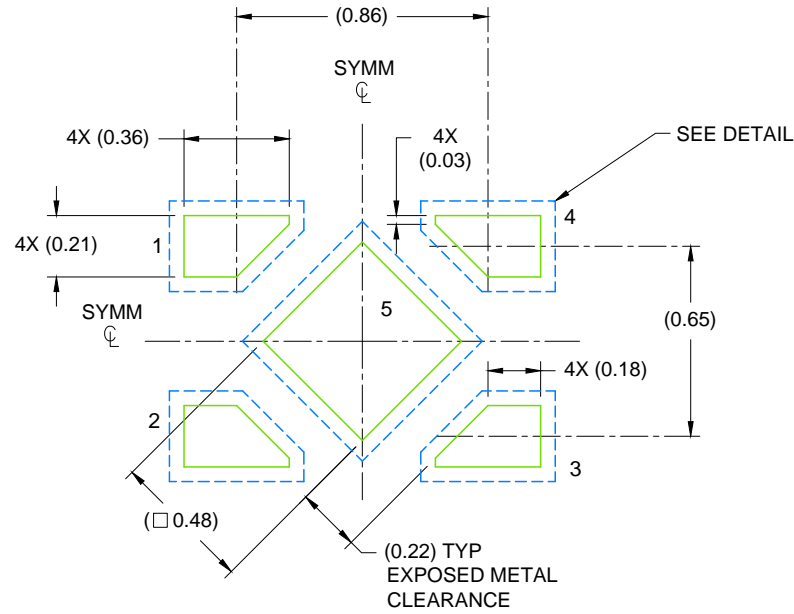

LAND PATTERN EXAMPLE  
SCALE: 40X

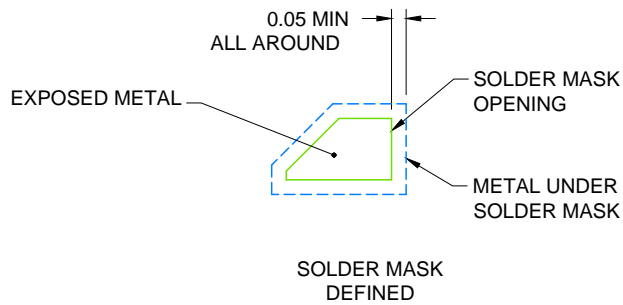

SOLDER MASK DETAIL

4215302/E 12/2016

NOTES: (continued)

7. This package is designed to be soldered to a thermal pad on the board. For more information, see Texas Instruments literature number SLUA271 ([www.ti.com/lit/sluea271](http://www.ti.com/lit/sluea271)).
8. If any vias are implemented, it is recommended that vias under paste be filled, plugged or tented.

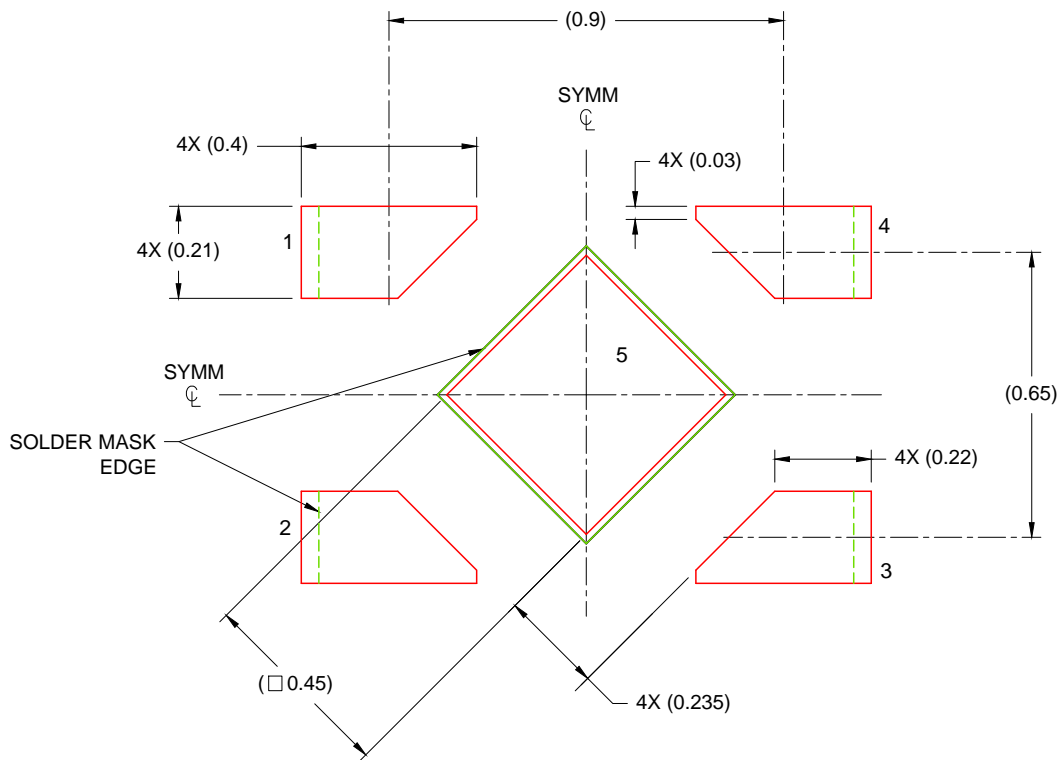

SOLDER PASTE EXAMPLE  
 BASED ON 0.075 - 0.1mm THICK STENCIL  
 EXPOSED PAD  
 88% PRINTED SOLDER COVERAGE BY AREA  
 SCALE: 60X

4215302/E 12/2016

NOTES: (continued)

- 9. Laser cutting apertures with trapezoidal walls and rounded corners may offer better paste release. IPC-7525 may have alternate design recommendations.

## IMPORTANT NOTICE

Texas Instruments Incorporated (TI) reserves the right to make corrections, enhancements, improvements and other changes to its semiconductor products and services per JESD46, latest issue, and to discontinue any product or service per JESD48, latest issue. Buyers should obtain the latest relevant information before placing orders and should verify that such information is current and complete.

TI's published terms of sale for semiconductor products (<http://www.ti.com/sc/docs/stdterms.htm>) apply to the sale of packaged integrated circuit products that TI has qualified and released to market. Additional terms may apply to the use or sale of other types of TI products and services.

Reproduction of significant portions of TI information in TI data sheets is permissible only if reproduction is without alteration and is accompanied by all associated warranties, conditions, limitations, and notices. TI is not responsible or liable for such reproduced documentation. Information of third parties may be subject to additional restrictions. Resale of TI products or services with statements different from or beyond the parameters stated by TI for that product or service voids all express and any implied warranties for the associated TI product or service and is an unfair and deceptive business practice. TI is not responsible or liable for any such statements.

Buyers and others who are developing systems that incorporate TI products (collectively, "Designers") understand and agree that Designers remain responsible for using their independent analysis, evaluation and judgment in designing their applications and that Designers have full and exclusive responsibility to assure the safety of Designers' applications and compliance of their applications (and of all TI products used in or for Designers' applications) with all applicable regulations, laws and other applicable requirements. Designer represents that, with respect to their applications, Designer has all the necessary expertise to create and implement safeguards that (1) anticipate dangerous consequences of failures, (2) monitor failures and their consequences, and (3) lessen the likelihood of failures that might cause harm and take appropriate actions. Designer agrees that prior to using or distributing any applications that include TI products, Designer will thoroughly test such applications and the functionality of such TI products as used in such applications.

TI's provision of technical, application or other design advice, quality characterization, reliability data or other services or information, including, but not limited to, reference designs and materials relating to evaluation modules, (collectively, "TI Resources") are intended to assist designers who are developing applications that incorporate TI products; by downloading, accessing or using TI Resources in any way, Designer (individually or, if Designer is acting on behalf of a company, Designer's company) agrees to use any particular TI Resource solely for this purpose and subject to the terms of this Notice.

TI's provision of TI Resources does not expand or otherwise alter TI's applicable published warranties or warranty disclaimers for TI products, and no additional obligations or liabilities arise from TI providing such TI Resources. TI reserves the right to make corrections, enhancements, improvements and other changes to its TI Resources. TI has not conducted any testing other than that specifically described in the published documentation for a particular TI Resource.

Designer is authorized to use, copy and modify any individual TI Resource only in connection with the development of applications that include the TI product(s) identified in such TI Resource. NO OTHER LICENSE, EXPRESS OR IMPLIED, BY ESTOPPEL OR OTHERWISE TO ANY OTHER TI INTELLECTUAL PROPERTY RIGHT, AND NO LICENSE TO ANY TECHNOLOGY OR INTELLECTUAL PROPERTY RIGHT OF TI OR ANY THIRD PARTY IS GRANTED HEREIN, including but not limited to any patent right, copyright, mask work right, or other intellectual property right relating to any combination, machine, or process in which TI products or services are used. Information regarding or referencing third-party products or services does not constitute a license to use such products or services, or a warranty or endorsement thereof. Use of TI Resources may require a license from a third party under the patents or other intellectual property of the third party, or a license from TI under the patents or other intellectual property of TI.

TI RESOURCES ARE PROVIDED "AS IS" AND WITH ALL FAULTS. TI DISCLAIMS ALL OTHER WARRANTIES OR REPRESENTATIONS, EXPRESS OR IMPLIED, REGARDING RESOURCES OR USE THEREOF, INCLUDING BUT NOT LIMITED TO ACCURACY OR COMPLETENESS, TITLE, ANY EPIDEMIC FAILURE WARRANTY AND ANY IMPLIED WARRANTIES OF MERCHANTABILITY, FITNESS FOR A PARTICULAR PURPOSE, AND NON-INFRINGEMENT OF ANY THIRD PARTY INTELLECTUAL PROPERTY RIGHTS. TI SHALL NOT BE LIABLE FOR AND SHALL NOT DEFEND OR INDEMNIFY DESIGNER AGAINST ANY CLAIM, INCLUDING BUT NOT LIMITED TO ANY INFRINGEMENT CLAIM THAT RELATES TO OR IS BASED ON ANY COMBINATION OF PRODUCTS EVEN IF DESCRIBED IN TI RESOURCES OR OTHERWISE. IN NO EVENT SHALL TI BE LIABLE FOR ANY ACTUAL, DIRECT, SPECIAL, COLLATERAL, INDIRECT, PUNITIVE, INCIDENTAL, CONSEQUENTIAL OR EXEMPLARY DAMAGES IN CONNECTION WITH OR ARISING OUT OF TI RESOURCES OR USE THEREOF, AND REGARDLESS OF WHETHER TI HAS BEEN ADVISED OF THE POSSIBILITY OF SUCH DAMAGES.

Unless TI has explicitly designated an individual product as meeting the requirements of a particular industry standard (e.g., ISO/TS 16949 and ISO 26262), TI is not responsible for any failure to meet such industry standard requirements.

Where TI specifically promotes products as facilitating functional safety or as compliant with industry functional safety standards, such products are intended to help enable customers to design and create their own applications that meet applicable functional safety standards and requirements. Using products in an application does not by itself establish any safety features in the application. Designers must ensure compliance with safety-related requirements and standards applicable to their applications. Designer may not use any TI products in life-critical medical equipment unless authorized officers of the parties have executed a special contract specifically governing such use. Life-critical medical equipment is medical equipment where failure of such equipment would cause serious bodily injury or death (e.g., life support, pacemakers, defibrillators, heart pumps, neurostimulators, and implantables). Such equipment includes, without limitation, all medical devices identified by the U.S. Food and Drug Administration as Class III devices and equivalent classifications outside the U.S.

TI may expressly designate certain products as completing a particular qualification (e.g., Q100, Military Grade, or Enhanced Product). Designers agree that it has the necessary expertise to select the product with the appropriate qualification designation for their applications and that proper product selection is at Designers' own risk. Designers are solely responsible for compliance with all legal and regulatory requirements in connection with such selection.

Designer will fully indemnify TI and its representatives against any damages, costs, losses, and/or liabilities arising out of Designer's non-compliance with the terms and provisions of this Notice.