

Low Loss DuoPack : IGBT in 2nd generation **TrenchStop®**
with soft, fast recovery anti-parallel Emitter Controlled Diode

- Short circuit withstand time – 10µs
- Designed for :
 - Frequency Converters
 - Uninterrupted Power Supply
- **TrenchStop®** 2nd generation for 1200 V applications offers :
 - very tight parameter distribution
 - high ruggedness, temperature stable behavior
- Easy paralleling capability due to positive temperature coefficient in $V_{CE(sat)}$
- Low EMI
- Low Gate Charge
- Very soft, fast recovery anti-parallel Emitter Controlled HE Diode
- Qualified according to JEDEC¹ for target applications
- Pb-free lead plating; RoHS compliant

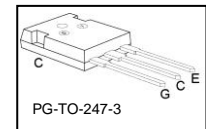
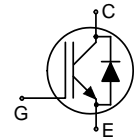

Complete product spectrum and PSpice Models : <http://www.infineon.com/igbt/>

| Type | V_{CE} | I_C | $V_{CE(sat), T_j=25^\circ C}$ | $T_{j,max}$ | Marking Code | Package |
|-------------|----------|-------|-------------------------------|-------------|--------------|-------------|
| IKW25N120T2 | 1200V | 25A | 1.7V | 175°C | K25T1202 | PG-TO-247-3 |

Maximum Ratings

| Parameter | Symbol | Value | Unit |
|---|--------------|------------|------|
| Collector-emitter voltage | V_{CE} | 1200 | V |
| DC collector current ($T_F=150^\circ C$) | I_C | | A |
| $T_C = 25^\circ C$ | | 50 | |
| $T_C = 110^\circ C$ | | 25 | |
| Pulsed collector current, t_p limited by $T_{j,max}$ | $I_{C,puls}$ | 100 | |
| Turn off safe operating area | - | 100 | |
| $V_{CE} \leq 1200V, T_j \leq 175^\circ C$ | | | |
| Diode forward current ($T_F=150^\circ C$) | I_F | | |
| $T_C = 25^\circ C$ | | 40 | |
| $T_C = 110^\circ C$ | | 25 | |
| Diode pulsed current, t_p limited by $T_{j,max}$ | $I_{F,puls}$ | 100 | |
| Gate-emitter voltage | V_{GE} | ± 20 | V |
| Short circuit withstand time ²⁾ | t_{SC} | 10 | µs |
| $V_{GE} = 15V, V_{CC} \leq 600V, T_{j,start} \leq 175^\circ C$ | | | |
| Power dissipation | P_{tot} | 349 | W |
| $T_C = 25^\circ C$ | | | |
| Operating junction temperature | T_j | -40...+175 | °C |
| Storage temperature | T_{stg} | -55...+150 | |
| Soldering temperature, 1.6mm (0.063 in.) from case for 10s Wavesoldering only, temperature on leads only | - | 260 | |

¹ J-STD-020 and JEDEC-022

²⁾ Allowed number of short circuits: <1000; time between short circuits: >1s.

Thermal Resistance

| Parameter | Symbol | Conditions | Max. Value | Unit |
|---|-------------|------------|------------|------|
| Characteristic | | | | |
| IGBT thermal resistance, junction – case | R_{thJC} | | 0.43 | K/W |
| Diode thermal resistance, junction – case | R_{thJCD} | | 0.81 | |
| Thermal resistance, junction – ambient | R_{thJA} | | 40 | |

Electrical Characteristic, at $T_j = 25^\circ\text{C}$, unless otherwise specified

| Parameter | Symbol | Conditions | Value | | | Unit |
|--------------------------------------|---------------|---|-------|------|------|------|
| | | | min. | typ. | max. | |
| Static Characteristic | | | | | | |
| Collector-emitter breakdown voltage | $V_{(BR)CES}$ | $V_{GE}=0V, I_C=500\mu A$ | 1200 | - | - | V |
| Collector-emitter saturation voltage | $V_{CE(sat)}$ | $V_{GE} = 15V, I_C=25A$ $T_j=25^\circ\text{C}$ $T_j=150^\circ\text{C}$ $T_j=175^\circ\text{C}$ | - | 1.7 | 2.2 | |
| | | | - | 2.1 | - | |
| | | | - | 2.2 | - | |
| Diode forward voltage | V_F | $V_{GE}=0V, I_F=25A$ $T_j=25^\circ\text{C}$ $T_j=150^\circ\text{C}$ $T_j=175^\circ\text{C}$ | - | 1.65 | 2.2 | |
| | | | - | 1.7 | - | |
| | | | - | 1.65 | - | |
| Gate-emitter threshold voltage | $V_{GE(th)}$ | $I_C=1.0mA, V_{CE}=V_{GE}$ | 5.2 | 5.8 | 6.4 | |
| Zero gate voltage collector current | I_{CES} | $V_{CE}=1200V, V_{GE}=0V$ $T_j=25^\circ\text{C}$ $T_j=150^\circ\text{C}$ $T_j=175^\circ\text{C}$ | - | - | 0.4 | mA |
| | | | - | - | 4.0 | |
| | | | - | - | 20 | |
| Gate-emitter leakage current | I_{GES} | $V_{CE}=0V, V_{GE}=20V$ | - | - | 200 | nA |
| Transconductance | g_{fs} | $V_{CE}=20V, I_C=25A$ | - | 13.5 | - | S |

Dynamic Characteristic

| | | | | | | |
|---|-------------|--|---|------------|---|----|
| Input capacitance | C_{iss} | $V_{CE}=25V,$ $V_{GE}=0V,$ $f=1MHz$ | - | 1600 | - | pF |
| Output capacitance | C_{oss} | | - | 155 | - | |
| Reverse transfer capacitance | C_{rss} | | - | 90 | - | |
| Gate charge | Q_{Gate} | $V_{CC}=960V, I_C=25A$ $V_{GE}=15V$ | - | 120 | - | nC |
| Internal emitter inductance measured 5mm (0.197 in.) from case | L_E | | - | 13 | - | nH |
| Short circuit collector current ¹⁾ | $I_{C(SC)}$ | $V_{GE}=15V, t_{SC} \leq 10\mu s$ $V_{CC} = 600V,$ $T_{j,start} = 25^\circ C$ $T_{j,start} = 175^\circ C$ | - | 150 115 | - | A |

Switching Characteristic, Inductive Load, at $T_j=25^\circ C$

| Parameter | Symbol | Conditions | Value | | | Unit |
|---|--------------|--|-------|------|------|-----------|
| | | | min. | typ. | max. | |
| IGBT Characteristic | | | | | | |
| Turn-on delay time | $t_{d(on)}$ | $T_j=25^\circ C,$ $V_{CC}=600V, I_C=25A,$ $V_{GE}=0/15V,$ $R_G=16.4\Omega,$ $L_\sigma^{(2)}=105nH,$ $C_\sigma^{(2)}=39pF$ Energy losses include "tail" and diode reverse recovery. | - | 27 | - | ns |
| Rise time | t_r | | - | 20 | - | |
| Turn-off delay time | $t_{d(off)}$ | | - | 265 | - | |
| Fall time | t_f | | - | 95 | - | |
| Turn-on energy | E_{on} | | - | 1.55 | - | mJ |
| Turn-off energy | E_{off} | | - | 1.35 | - | |
| Total switching energy | E_{ts} | | - | 2.9 | - | |
| Anti-Parallel Diode Characteristic | | | | | | |
| Diode reverse recovery time | t_{rr} | $T_j=25^\circ C,$ | - | 195 | - | ns |
| Diode reverse recovery charge | Q_{rr} | $V_R=600V, I_F=25A,$ | - | 2.05 | - | μC |
| Diode peak reverse recovery current | I_{rrm} | $di_F/dt=1050A/\mu s$ | - | 20 | - | A |
| Diode peak rate of fall of reverse recovery current during t_b | di_{rr}/dt | | - | 475 | - | $A/\mu s$ |

¹⁾ Allowed number of short circuits: <1000; time between short circuits: >1s.

²⁾ Leakage inductance L_σ and Stray capacity C_σ due to dynamic test circuit in Figure E.

Switching Characteristic, Inductive Load, at $T_j=175^\circ\text{C}$

| Parameter | Symbol | Conditions | Value | | | Unit | |
|--|--------------|---|--|------|------|------------------------|----|
| | | | min. | typ. | max. | | |
| IGBT Characteristic | | | | | | | |
| Turn-on delay time | $t_{d(on)}$ | $T_j=175^\circ\text{C}$ $V_{CC}=600\text{V}, I_C=25\text{A},$ $V_{GE}=0/15\text{V},$ $R_G=16.4\Omega,$ $L_{\sigma}^{1)}=175\text{nH},$ $C_{\sigma}^{1)}=67\text{pF}$ Energy losses include "tail" and diode reverse recovery. | - | 25 | - | ns | |
| Rise time | t_r | | - | 24 | - | | |
| Turn-off delay time | $t_{d(off)}$ | | - | 340 | - | | |
| Fall time | t_f | | - | 164 | - | | |
| Turn-on energy | E_{on} | | Energy losses include "tail" and diode reverse recovery. | - | 2.25 | - | mJ |
| Turn-off energy | E_{off} | | | - | 2.05 | - | |
| Total switching energy | E_{ts} | | | - | 4.3 | - | |
| Anti-Parallel Diode Characteristic | | | | | | | |
| Diode reverse recovery time | t_{rr} | $T_j=175^\circ\text{C}$ $V_R=600\text{V}, I_F=25\text{A},$ $di_F/dt=1000\text{A}/\mu\text{s}$ | - | 290 | - | ns | |
| Diode reverse recovery charge | Q_{rr} | | - | 3.65 | - | μC | |
| Diode peak reverse recovery current | I_{rrm} | | - | 24 | - | A | |
| Diode peak rate of fall of reverse recovery current during t_b | di_{rr}/dt | | - | 330 | | $\text{A}/\mu\text{s}$ | |

¹⁾ Leakage inductance L_{σ} and Stray capacity C_{σ} due to dynamic test circuit in Figure E.

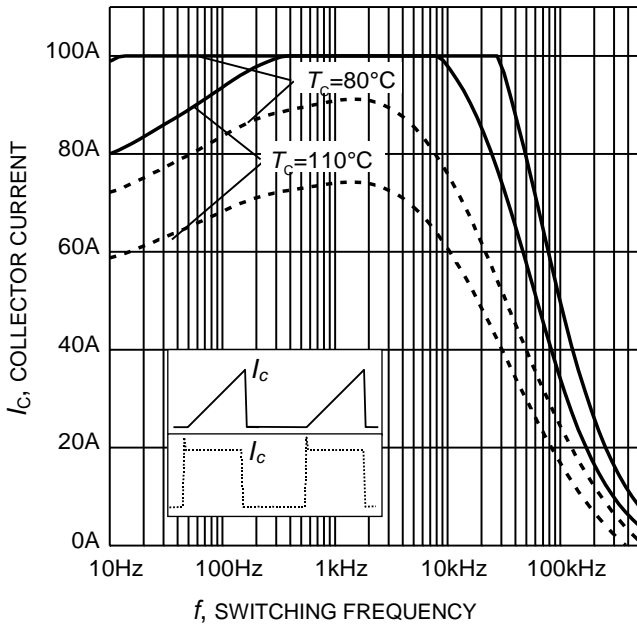

Figure 1. Collector current as a function of switching frequency
 ($T_j \leq 175^\circ\text{C}$, $D = 0.5$, $V_{CE} = 600\text{V}$,
 $V_{GE} = 0/+15\text{V}$, $R_G = 12\Omega$)

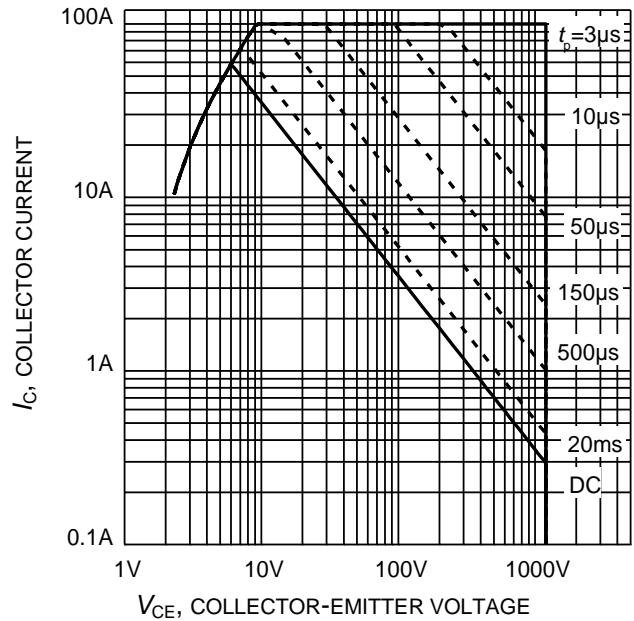

Figure 2. Safe operating area
 ($D = 0$, $T_C = 25^\circ\text{C}$,
 $T_j \leq 175^\circ\text{C}$; $V_{GE} = 15\text{V}$)

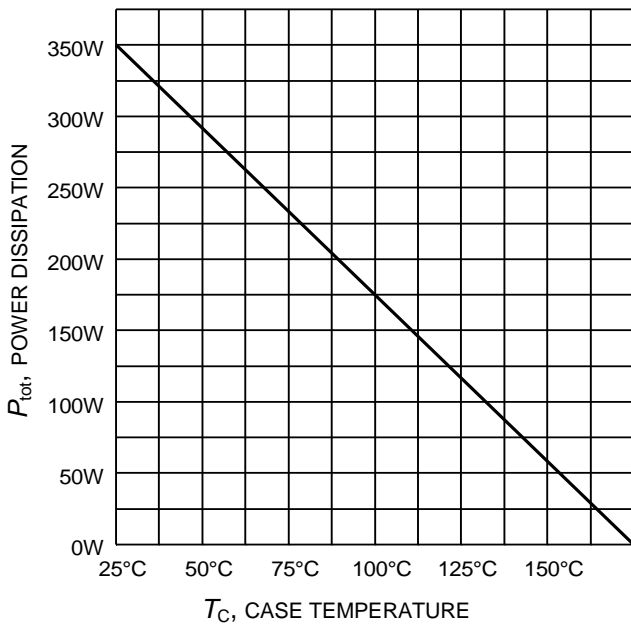

Figure 3. Maximum power dissipation as a function of case temperature
 ($T_j \leq 175^\circ\text{C}$)

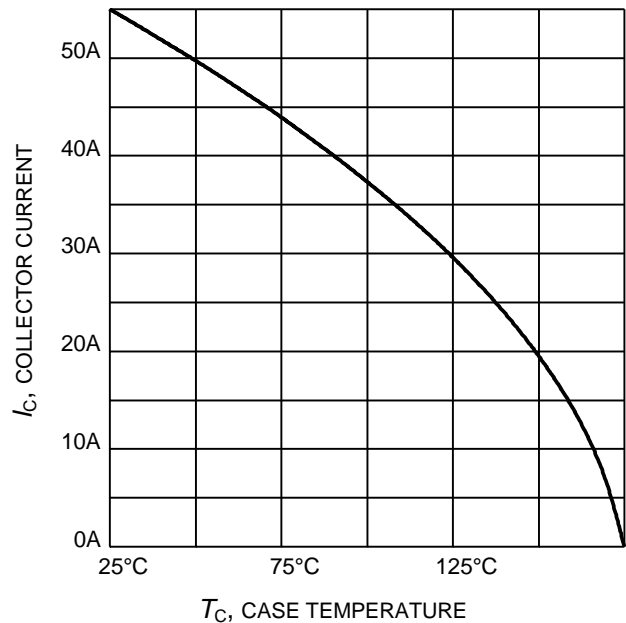

Figure 4. Maximum collector current as a function of case temperature
 ($V_{GE} \geq 15\text{V}$, $T_j \leq 175^\circ\text{C}$)

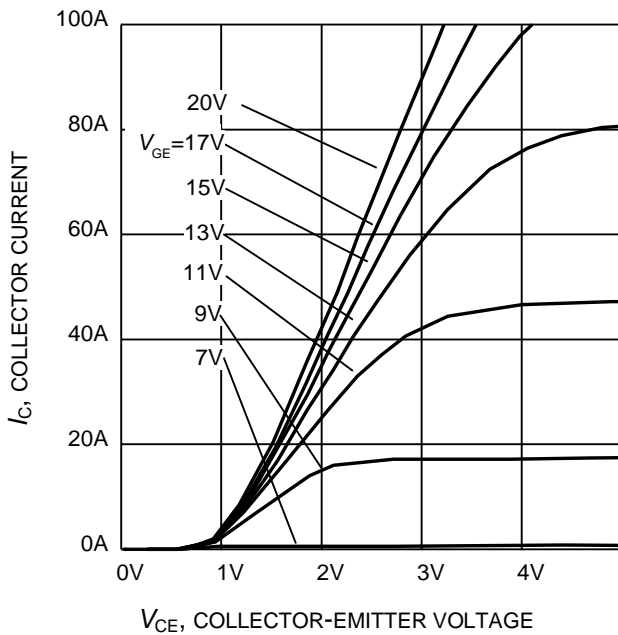

Figure 5. Typical output characteristic
($T_j = 25^\circ\text{C}$)

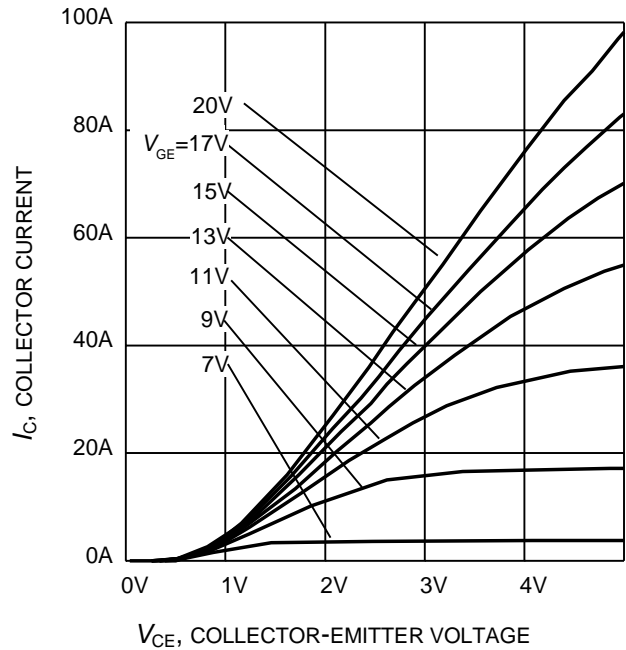

Figure 6. Typical output characteristic
($T_j = 175^\circ\text{C}$)

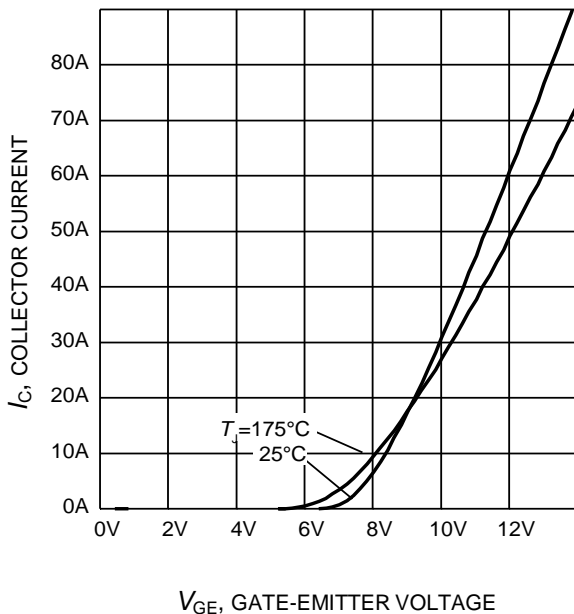

Figure 7. Typical transfer characteristic
($V_{CE} = 20\text{V}$)

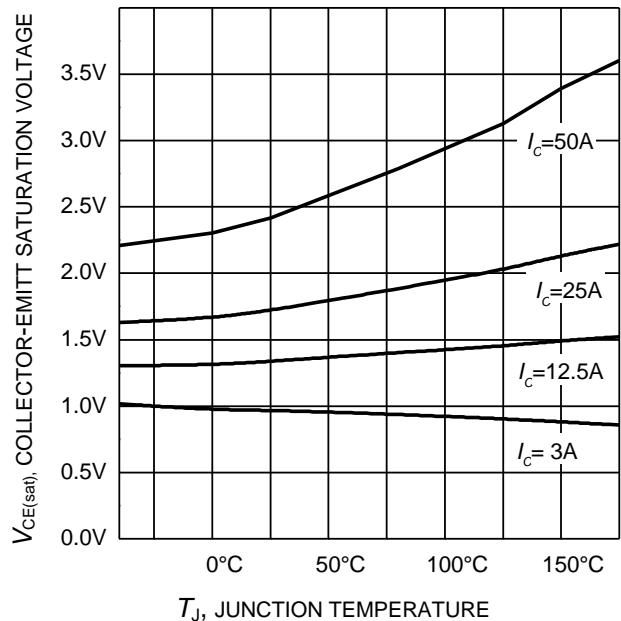

Figure 8. Typical collector-emitter saturation voltage as a function of junction temperature
($V_{GE} = 15\text{V}$)

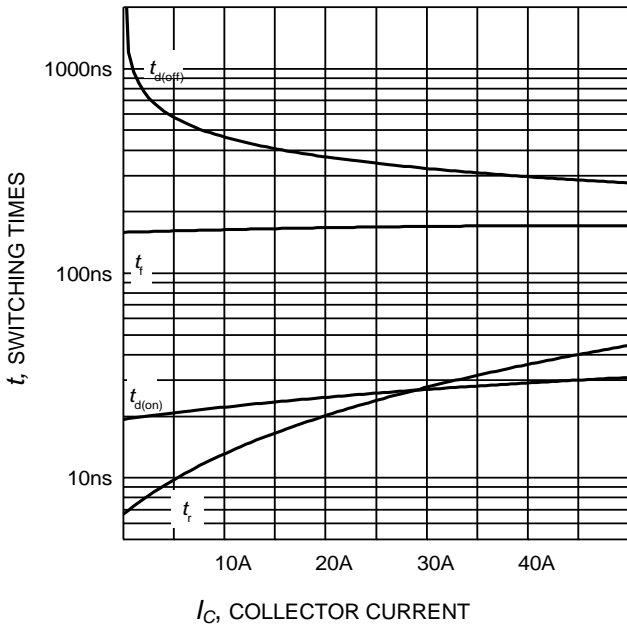

Figure 9. Typical switching times as a function of collector current
 (inductive load, $T_J=175^\circ\text{C}$,
 $V_{CE}=600\text{V}$, $V_{GE}=0/15\text{V}$, $R_G=16.4\Omega$,
 Dynamic test circuit in Figure E)

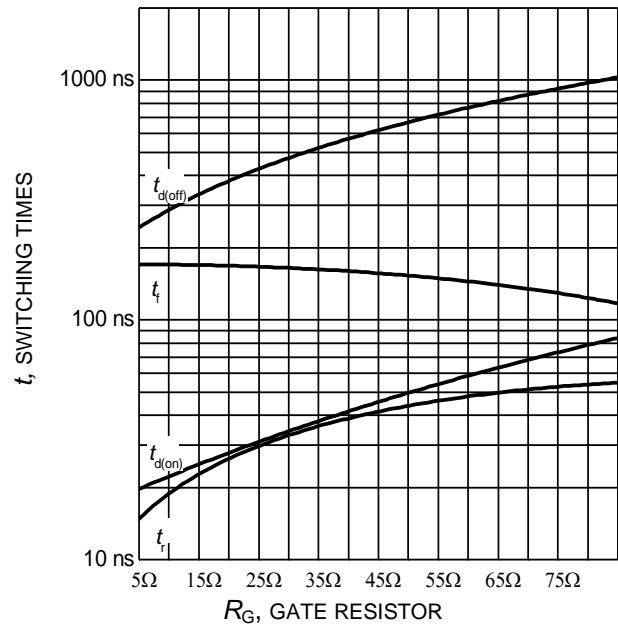

Figure 10. Typical switching times as a function of gate resistor
 (inductive load, $T_J=175^\circ\text{C}$,
 $V_{CE}=600\text{V}$, $V_{GE}=0/15\text{V}$, $I_C=25\text{A}$,
 Dynamic test circuit in Figure E)

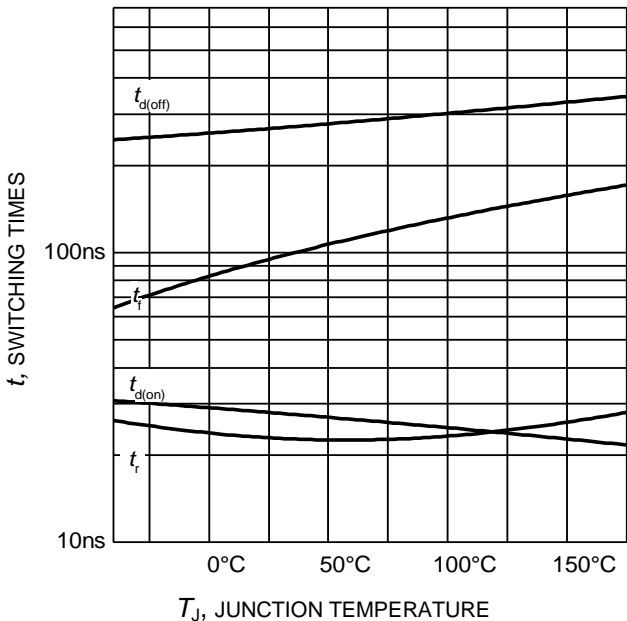

Figure 11. Typical switching times as a function of junction temperature
 (inductive load, $V_{CE}=600\text{V}$,
 $V_{GE}=0/15\text{V}$, $I_C=25\text{A}$, $R_G=16.4\Omega$,
 Dynamic test circuit in Figure E)

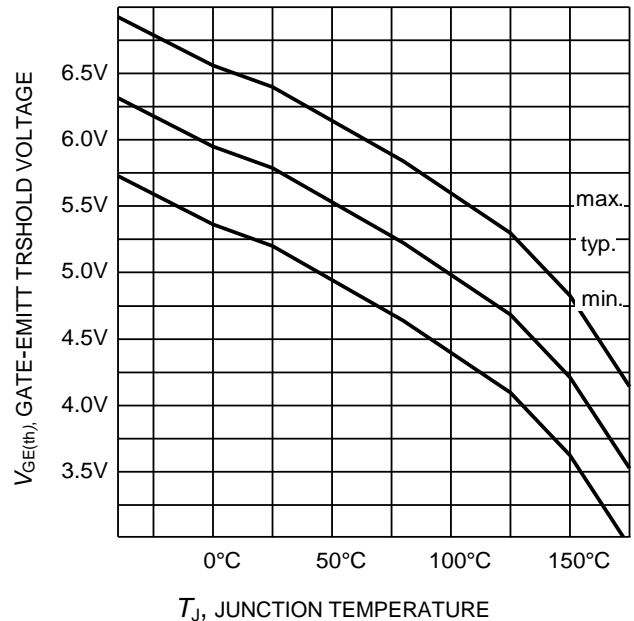

Figure 12. Gate-emitter threshold voltage as a function of junction temperature
 ($I_C = 1.0\text{mA}$)

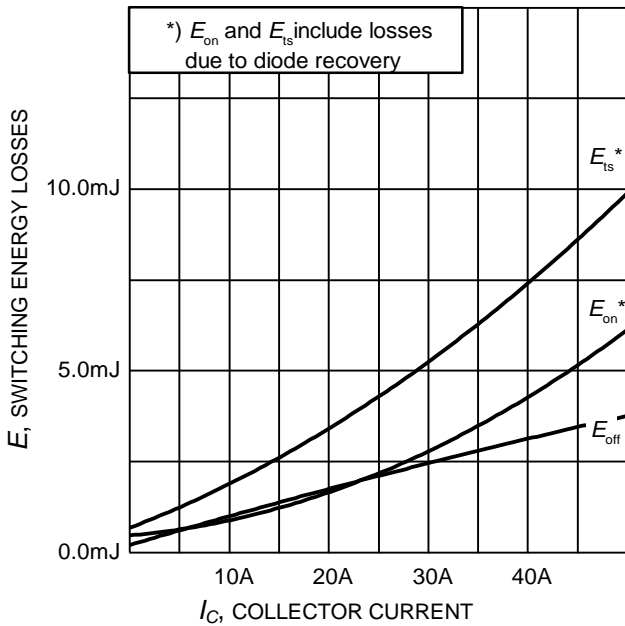

Figure 13. Typical switching energy losses as a function of collector current
 (inductive load, $T_J=175^\circ\text{C}$, $V_{CE}=600\text{V}$, $V_{GE}=0/15\text{V}$, $R_G=16.4\Omega$, Dynamic test circuit in Figure E)

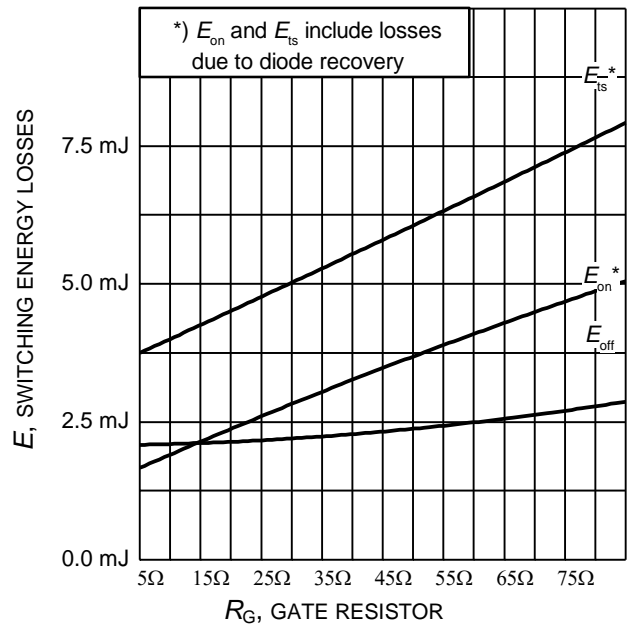

Figure 14. Typical switching energy losses as a function of gate resistor
 (inductive load, $T_J=175^\circ\text{C}$, $V_{CE}=600\text{V}$, $V_{GE}=0/15\text{V}$, $I_C=25\text{A}$, Dynamic test circuit in Figure E)

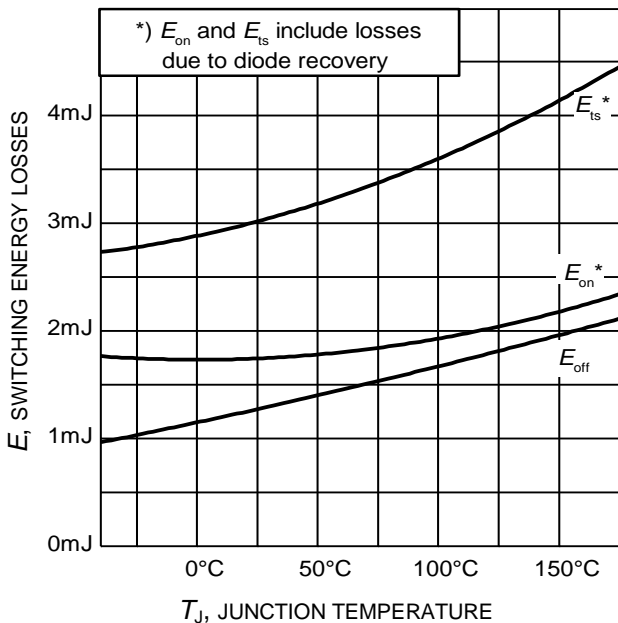

Figure 15. Typical switching energy losses as a function of junction temperature
 (inductive load, $V_{CE}=600\text{V}$, $V_{GE}=0/15\text{V}$, $I_C=25\text{A}$, $R_G=16.4\Omega$, Dynamic test circuit in Figure E)

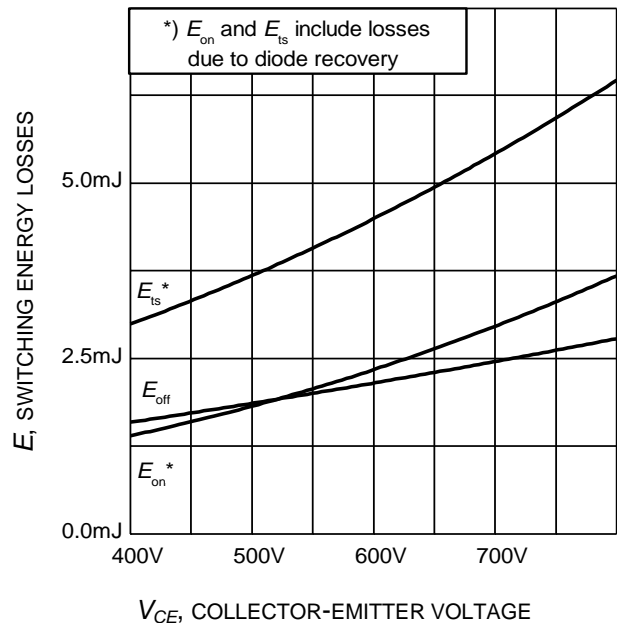

Figure 16. Typical switching energy losses as a function of collector emitter voltage
 (inductive load, $T_J=175^\circ\text{C}$, $V_{GE}=0/15\text{V}$, $I_C=25\text{A}$, $R_G=16.4\Omega$, Dynamic test circuit in Figure E)

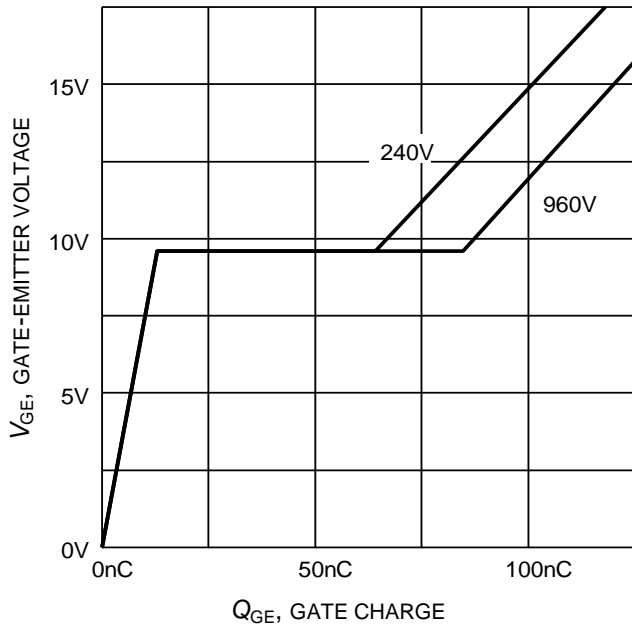

Figure 17. Typical gate charge
($I_C=25\text{ A}$)

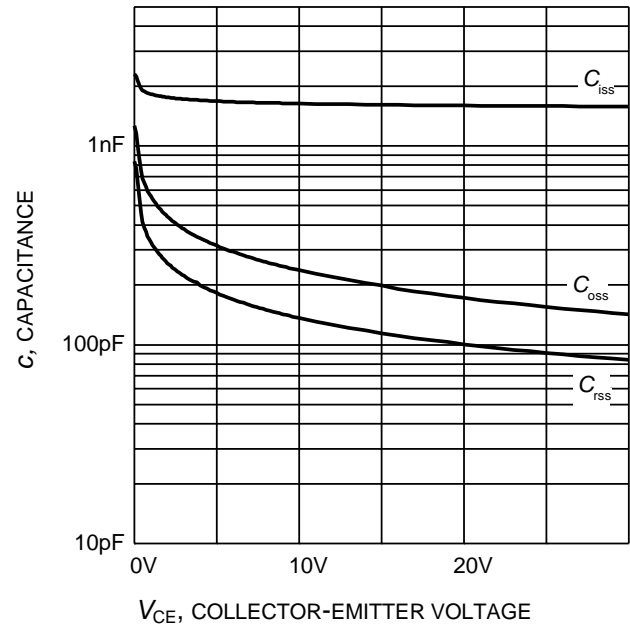

Figure 18. Typical capacitance as a function of collector-emitter voltage
($V_{GE}=0\text{V}$, $f = 1\text{ MHz}$)

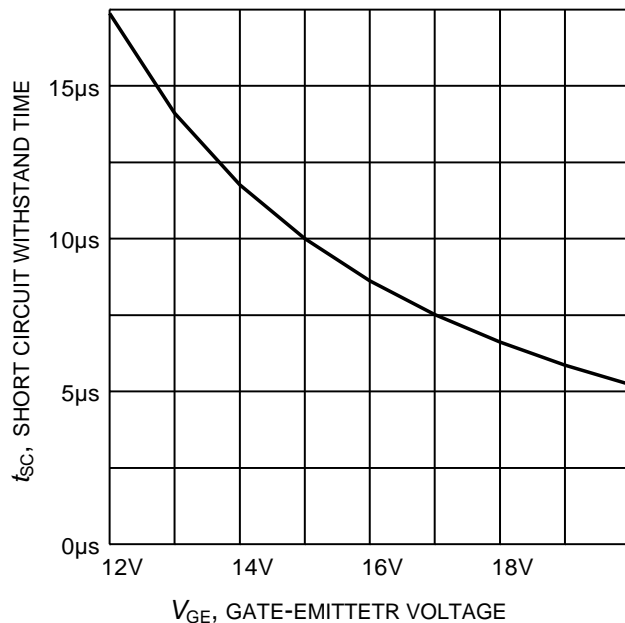

Figure 19. Short circuit withstand time as a function of gate-emitter voltage
($V_{CE}=600\text{V}$, start at $T_J \leq 175^\circ\text{C}$)

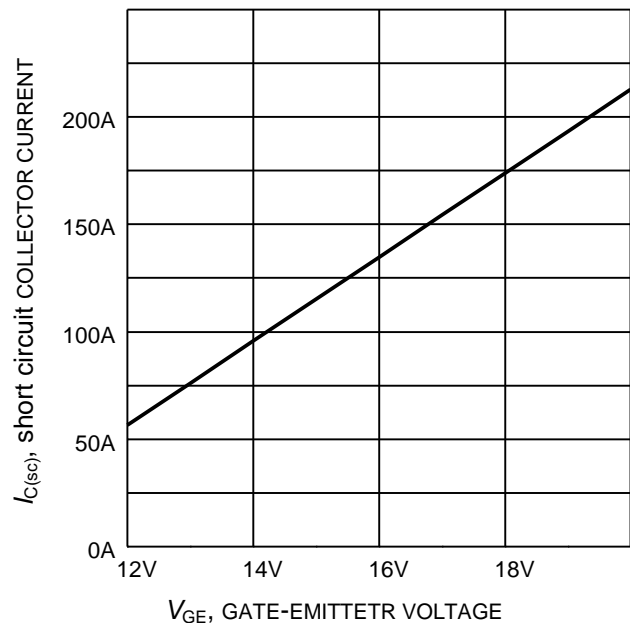

Figure 20. Typical short circuit collector current as a function of gate-emitter voltage
($V_{CE} \leq 600\text{V}$, $T_{j,start} = 175^\circ\text{C}$)

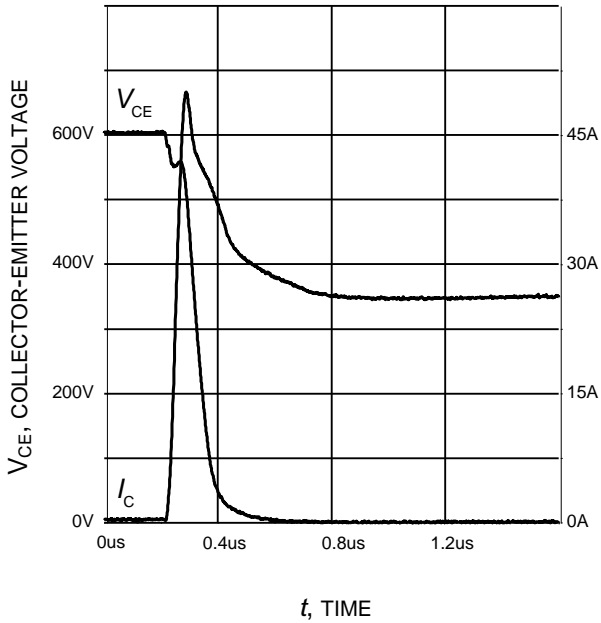

Figure 21. Typical turn on behavior
 ($V_{GE}=0/15V$, $R_G=16.4\Omega$, $T_j = 175^\circ C$,
 Dynamic test circuit in Figure E)

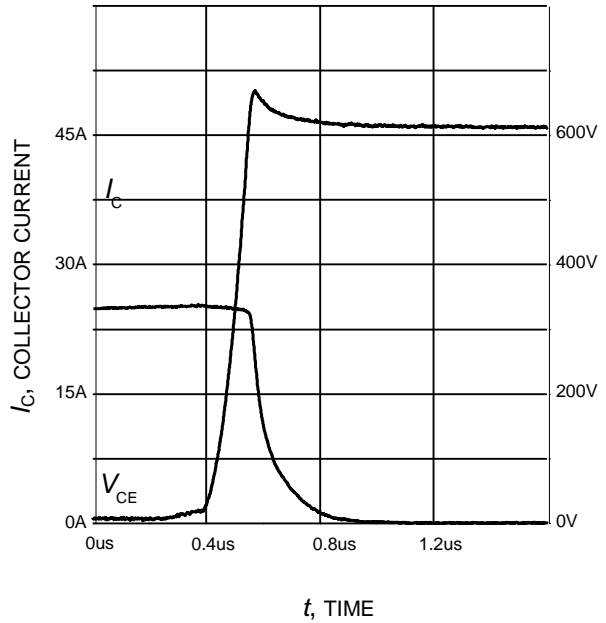

Figure 22. Typical turn off behavior
 ($V_{GE}=15/0V$, $R_G=16.4\Omega$, $T_j = 175^\circ C$,
 Dynamic test circuit in Figure E)

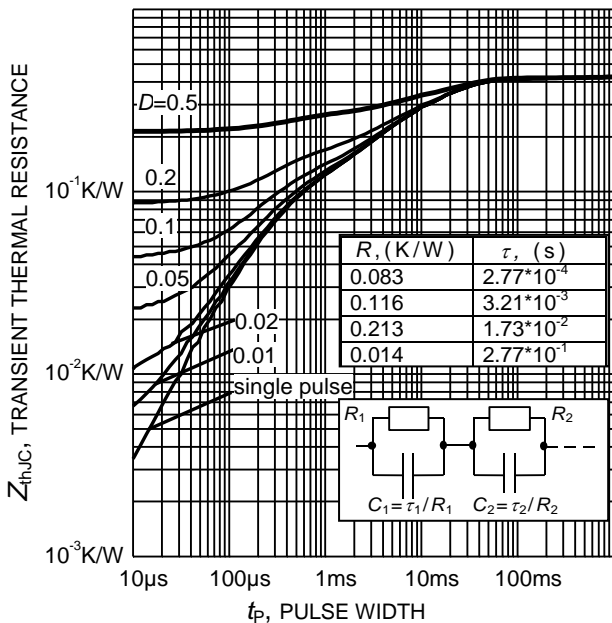

Figure 23. IGBT transient thermal resistance
 ($D = t_p / T$)

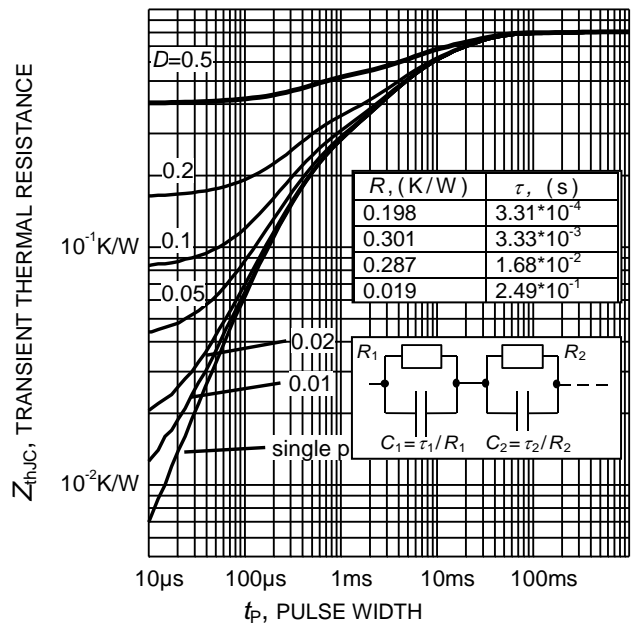

Figure 24. Diode transient thermal impedance as a function of pulse width
 ($D = t_p / T$)

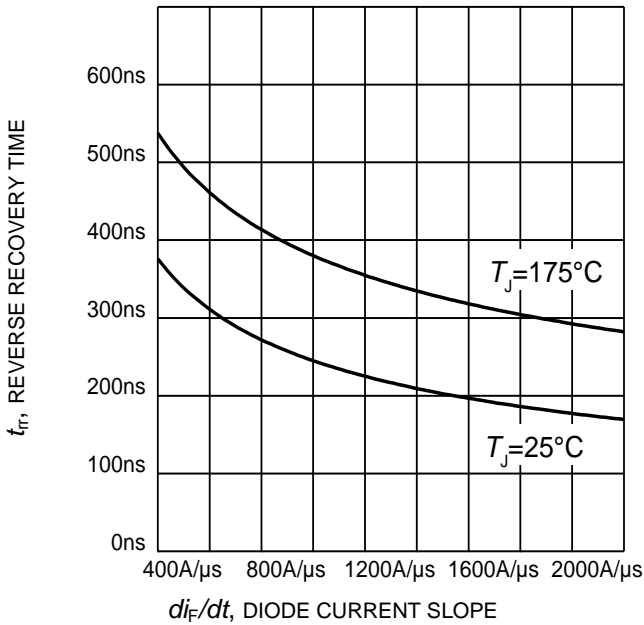

Figure 23. Typical reverse recovery time as a function of diode current slope
 ($V_R=600V$, $I_F=25A$,
 Dynamic test circuit in Figure E)

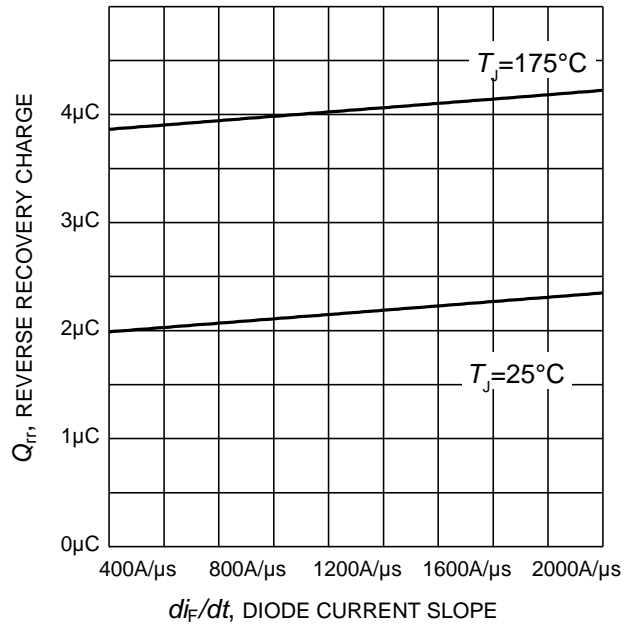

Figure 24. Typical reverse recovery charge as a function of diode current slope
 ($V_R=600V$, $I_F=25A$,
 Dynamic test circuit in Figure E)

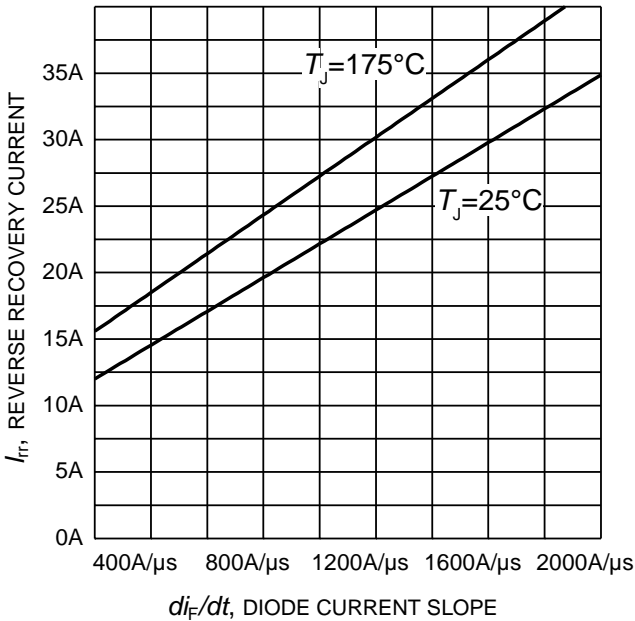

Figure 25. Typical reverse recovery current as a function of diode current slope
 ($V_R=600V$, $I_F=25A$,
 Dynamic test circuit in Figure E)

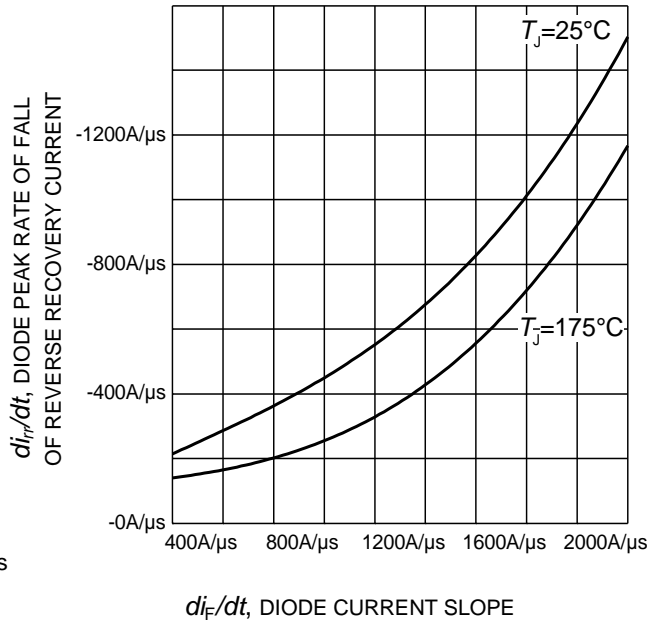

Figure 26. Typical diode peak rate of fall of reverse recovery current as a function of diode current slope
 ($V_R=600V$, $I_F=25A$,
 Dynamic test circuit in Figure E)

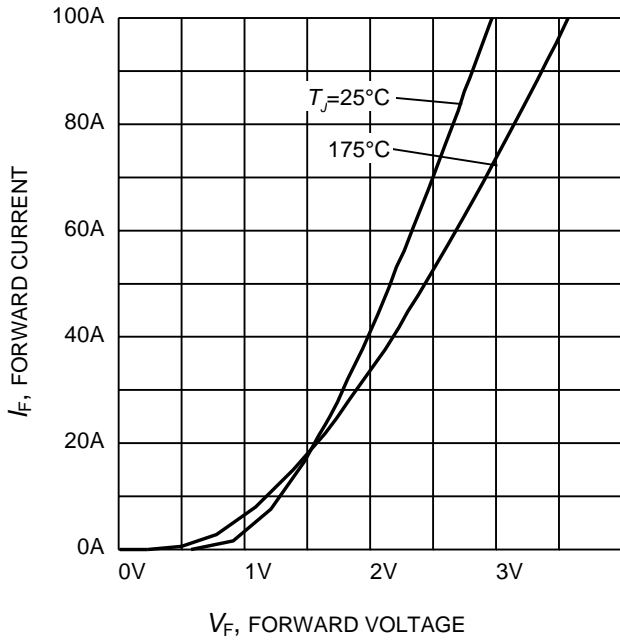

Figure 27. Typical diode forward current as a function of forward voltage

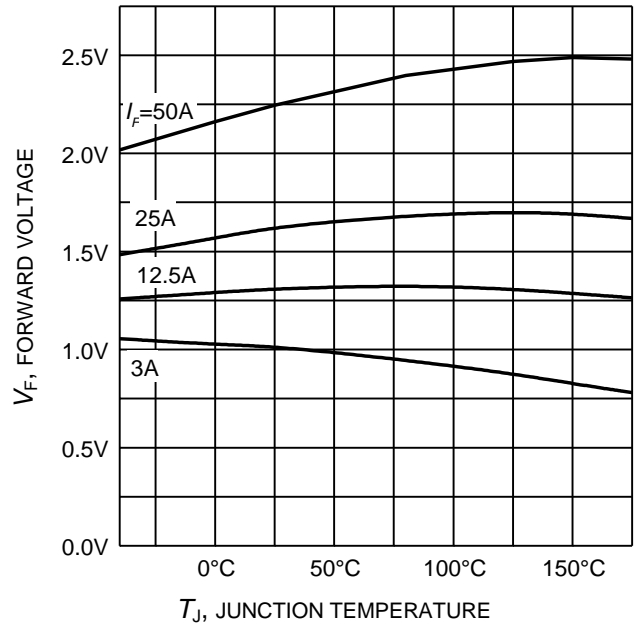
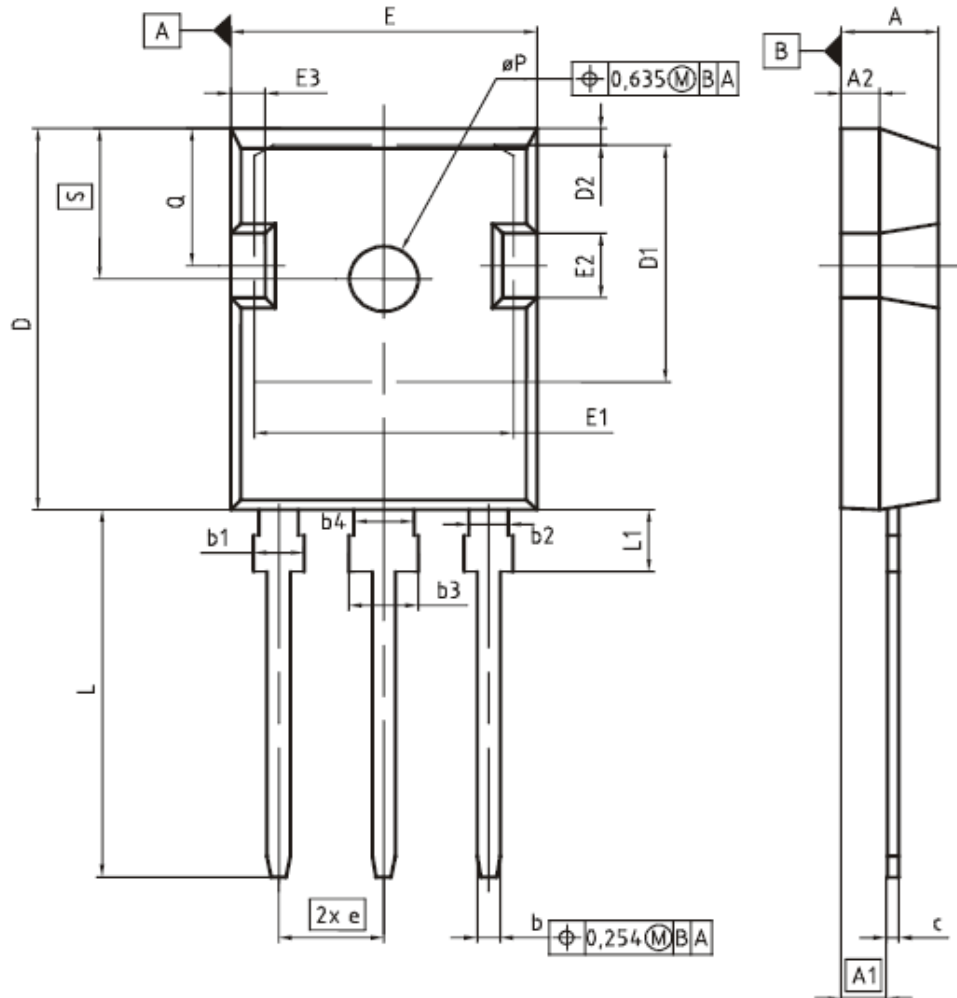

Figure 28. Typical diode forward voltage as a function of junction temperature

PG-TO247-3



| DIM | MILLIMETERS | | INCHES | |
|-----|-------------|-------|-------------|-------|
| | MIN | MAX | MIN | MAX |
| A | 4,83 | 5,21 | 0,190 | 0,205 |
| A1 | 2,27 | 2,54 | 0,089 | 0,100 |
| A2 | 1,85 | 2,16 | 0,073 | 0,085 |
| b | 1,07 | 1,33 | 0,042 | 0,052 |
| b1 | 1,90 | 2,41 | 0,075 | 0,095 |
| b2 | 1,90 | 2,16 | 0,075 | 0,085 |
| b3 | 2,87 | 3,38 | 0,113 | 0,133 |
| b4 | 2,87 | 3,13 | 0,113 | 0,123 |
| c | 0,55 | 0,68 | 0,022 | 0,027 |
| D | 20,80 | 21,10 | 0,819 | 0,831 |
| D1 | 16,25 | 17,65 | 0,640 | 0,695 |
| D2 | 0,95 | 1,35 | 0,037 | 0,053 |
| E | 15,70 | 16,13 | 0,618 | 0,635 |
| E1 | 13,10 | 14,15 | 0,516 | 0,557 |
| E2 | 3,68 | 5,10 | 0,145 | 0,201 |
| E3 | 1,00 | 2,60 | 0,039 | 0,102 |
| e | 5,44 (BSC) | | 0,214 (BSC) | |
| N | 3 | | 3 | |
| L | 19,80 | 20,32 | 0,780 | 0,800 |
| L1 | 4,10 | 4,47 | 0,161 | 0,176 |
| øP | 3,50 | 3,70 | 0,138 | 0,146 |
| Q | 5,49 | 6,00 | 0,216 | 0,236 |
| S | 6,04 | 6,30 | 0,238 | 0,248 |

DOCUMENT NO.
Z8B00003327

SCALE

EUROPEAN PROJECTION

ISSUE DATE
09-07-2010

REVISION
05

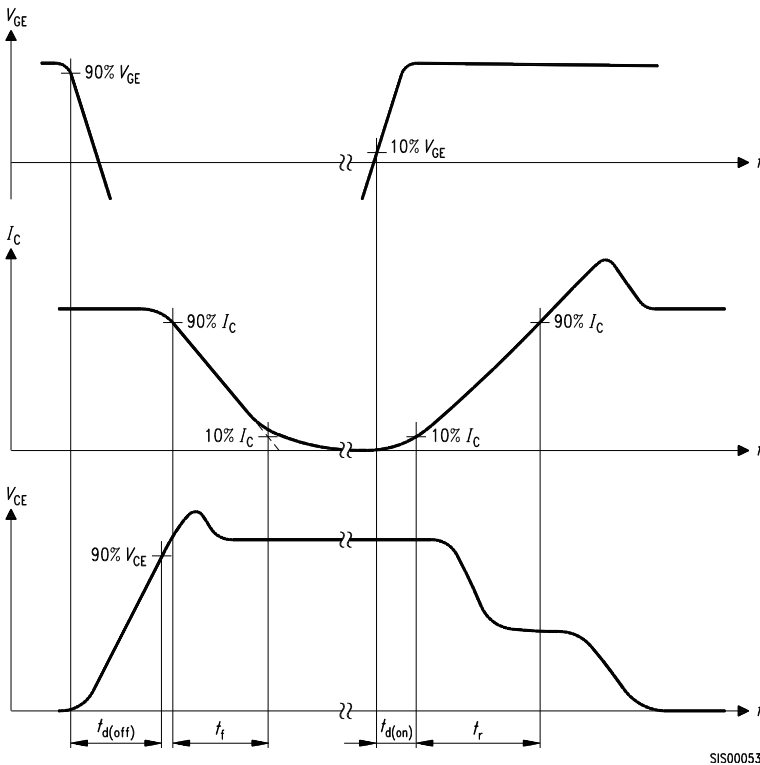

Figure A. Definition of switching times

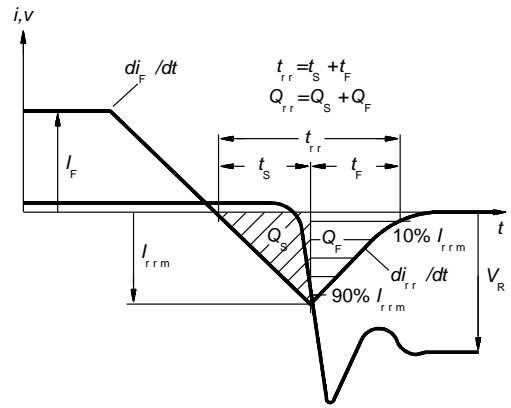

Figure C. Definition of diodes switching characteristics

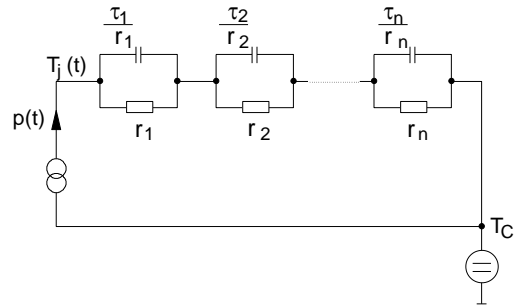

Figure D. Thermal equivalent circuit

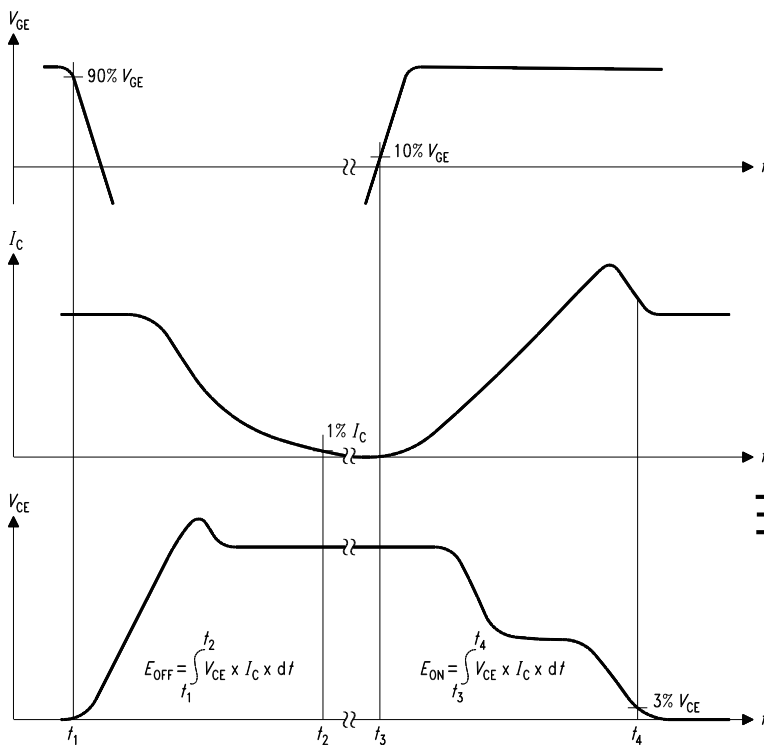

Figure B. Definition of switching losses

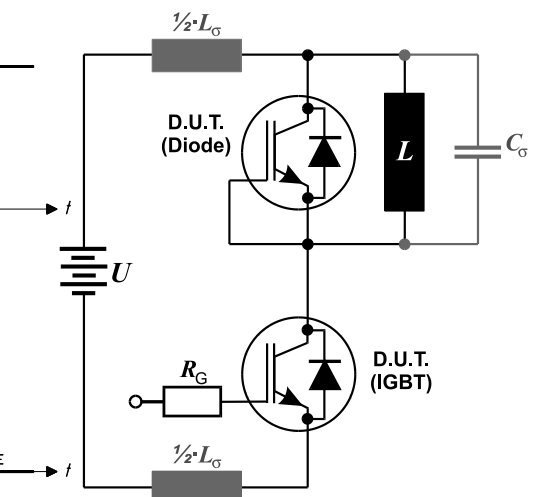

Figure E. Dynamic test circuit

Published by
Infineon Technologies AG
81726 Munich, Germany
© 2013 Infineon Technologies AG
All Rights Reserved.

Legal Disclaimer

The information given in this document shall in no event be regarded as a guarantee of conditions or characteristics. With respect to any examples or hints given herein, any typical values stated herein and/or any information regarding the application of the device, Infineon Technologies hereby disclaims any and all warranties and liabilities of any kind, including without limitation, warranties of non-infringement of intellectual property rights of any third party.

Information

For further information on technology, delivery terms and conditions and prices, please contact the nearest Infineon Technologies Office (www.infineon.com).

Warnings

Due to technical requirements, components may contain dangerous substances. For information on the types in question, please contact the nearest Infineon Technologies Office.

The Infineon Technologies component described in this Data Sheet may be used in life-support devices or systems and/or automotive, aviation and aerospace applications or systems only with the express written approval of Infineon Technologies, if a failure of such components can reasonably be expected to cause the failure of that life-support, automotive, aviation and aerospace device or system or to affect the safety or effectiveness of that device or system. Life support devices or systems are intended to be implanted in the human body or to support and/or maintain and sustain and/or protect human life. If they fail, it is reasonable to assume that the health of the user or other persons may be endangered.