

## SOT-363 Plastic-Encapsulate Diodes

### **BAT54ADW /BAT54BRW / BAT54CDW /BAT54SDW /BAT54TW BAT54DW/BAT54JW**

SCHOTTKY BARRIER DIODE ARRAYS

#### FEATURES

- Low Forward Voltage Drop
- Fast Switching
- Small Surface Mount Package
- PN Junction Guard Ring for Transient and ESD Protection
- Available in Lead Free Version

#### MARKING:

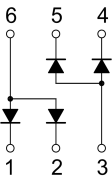
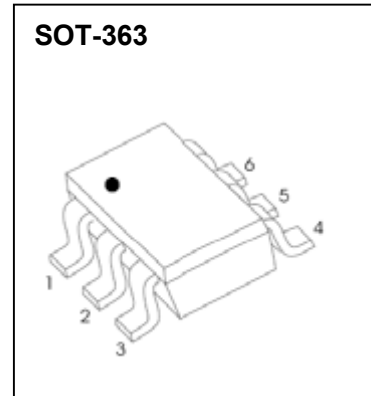

**BAT54ADW**

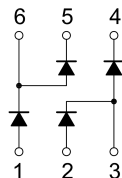

**BAT54BRW**

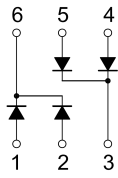

**BAT54CDW**

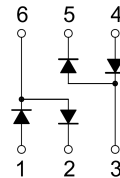

**BAT54SDW**

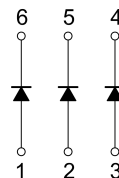



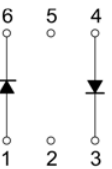

**BAT54TW**

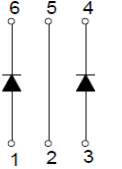



**BAT54DW**

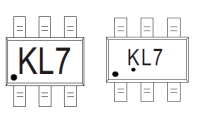

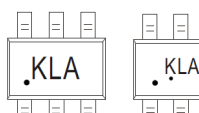
**BAT54JW**

BAT54ADW	BAT54BRW	BAT54CDW	BAT54SDW	BAT54TW
				

BAT54DW	BAT54JW
	

Solid dot = Green molding compound device,if none, the normal device.

Solid dot = Pin1 indicate.

## ELECTRICAL CHARACTERISTICS

### MAXIMUM RATINGS ( $T_a=25^{\circ}\text{C}$ unless otherwise noted )

Symbol	Parameter	Value	Unit
$V_{RRM}$	Repetitive Peak Reverse Voltage	30	V
$V_{RWM}$	Peak Working Reverse Voltage		
$V_R$	DC Blocking Voltage		
$I_O$	Forward Continuous Current	200	mA
$I_{FRM}$	Repetitive Peak Forward Current	300	mA
$I_{FSM}$	Non-repetitive Peak Forward Surge Current @ $t=8.3\text{ms}$	600	
$P_D$	Power Dissipation	200	mW
$R_{\theta JA}$	Thermal Resistance From Junction To Ambient	500	$^{\circ}\text{C}/\text{W}$
$T_j$	Junction Temperature	125	$^{\circ}\text{C}$
$T_{stg}$	Storage Temperature	-55~+150	$^{\circ}\text{C}$

### ELECTRICAL CHARACTERISTICS ( $T_a=25^{\circ}\text{C}$ unless otherwise specified)

Parameter	Symbol	Test conditions	Min	Typ	Max	Unit
Reverse voltage	$V_{(BR)}$	$I_R=100\mu\text{A}$	30			V
Reverse current	$I_R$	$V_R=25\text{V}$			2	$\mu\text{A}$
Forward voltage	$V_F$	$I_F=1\text{mA}$			320	mV
		$I_F=10\text{mA}$			400	
		$I_F=30\text{mA}$			500	
		$I_F=100\text{mA}$			1000	
Total capacitance	$C_{tot}$	$V_R=1\text{V}, f=1\text{MHz}$			10	pF
Reverse recovery time	$t_{rr}$	$I_F=I_R=10\text{mA}, I_{rr}=0.1 \times I_R, R_L=100\Omega$			5	ns

# Typical Characteristics

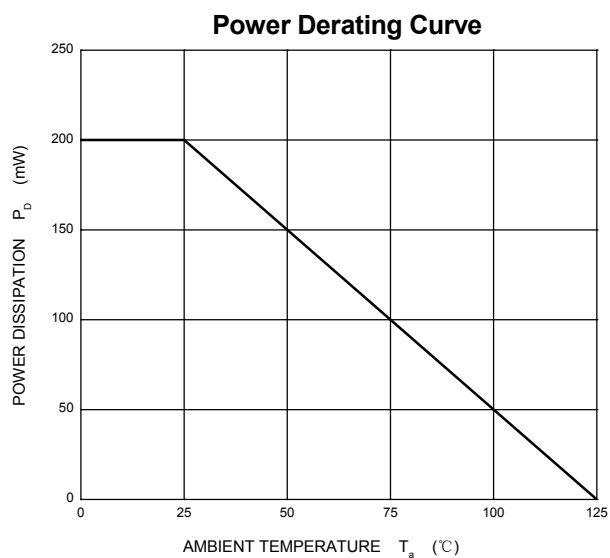
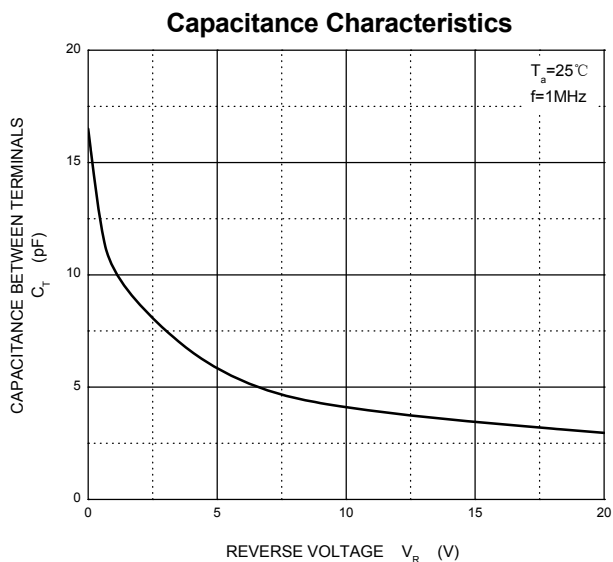
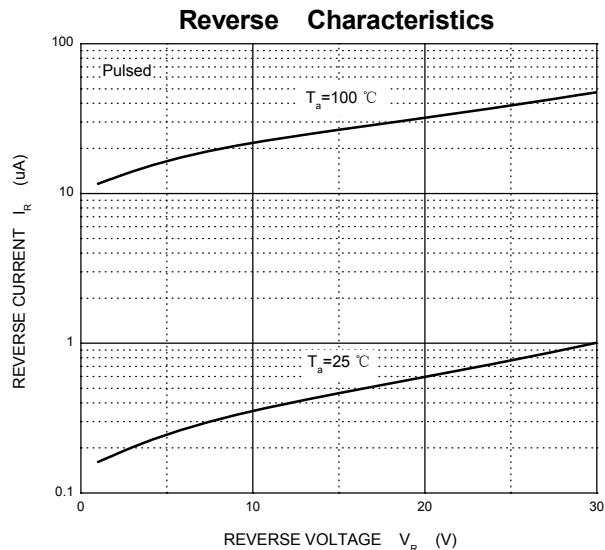
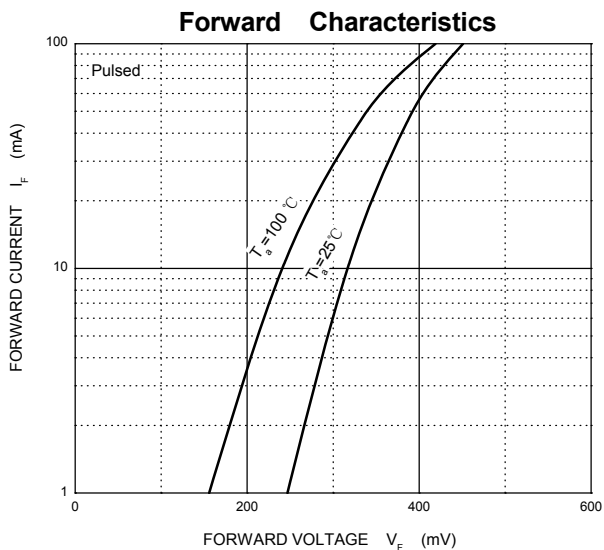

## SOT-363 Package Outline Dimensions

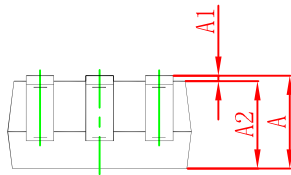
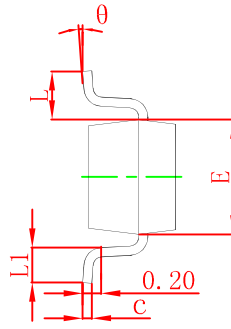
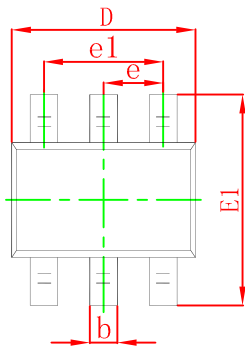

Symbol	Dimensions In Millimeters		Dimensions In Inches	
	Min	Max	Min	Max
A	0.900	1.100	0.035	0.043
A1	0.000	0.100	0.000	0.004
A2	0.900	1.000	0.035	0.039
b	0.150	0.350	0.006	0.014
c	0.100	0.150	0.004	0.006
D	2.000	2.200	0.079	0.087
E	1.150	1.350	0.045	0.053
E1	2.150	2.400	0.085	0.094
e	0.650 TYP		0.026 TYP	
e1	1.200	1.400	0.047	0.055
L	0.525 REF		0.021 REF	
L1	0.260	0.460	0.010	0.018
theta	0°	8°	0°	8°

## SOT-363 Suggested Pad Layout

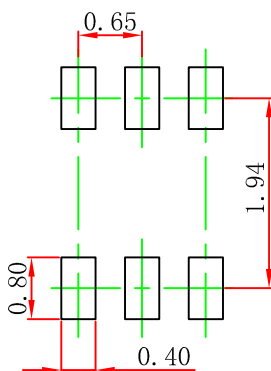

### Note:

1. Controlling dimension: in millimeters.
2. General tolerance:  $\pm 0.05\text{mm}$ .
3. The pad layout is for reference purposes only.

## NOTICE

JCET reserve the right to make modifications, enhancements, improvements, corrections or other changes without further notice to any product herein. JCET does not assume any liability arising out of the application or use of any product described herein.

## SOT-363 Embossed Carrier Tape

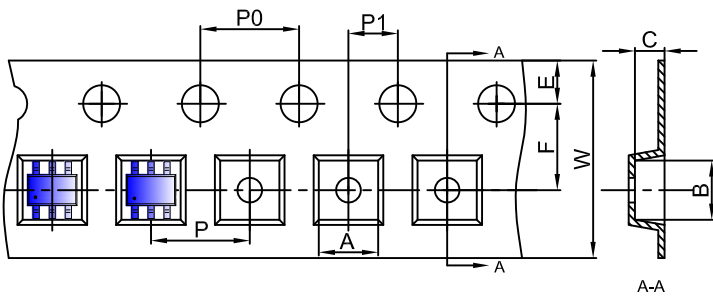

### Packaging Description:

SOT-363 parts are shipped in tape. The carrier tape is made from a dissipative (carbon filled) polycarbonate resin. The cover tape is a multilayer film (Heat Activated Adhesive in nature) primarily composed of polyester film, adhesive layer, sealant, and anti-static sprayed agent. These reeled parts in standard option are shipped with 3,000 units per 7" or 17.8cm diameter reel. The reels are clear in color and is made of polystyrene plastic (anti-static coated).

Dimensions are in millimeter										
Pkg type	A	B	C	d	E	F	P0	P	P1	W
SOT-363	2.25	2.55	1.20	Ø1.50	1.75	3.50	4.00	4.00	2.00	8.00

## SOT-363 Tape Leader and Trailer

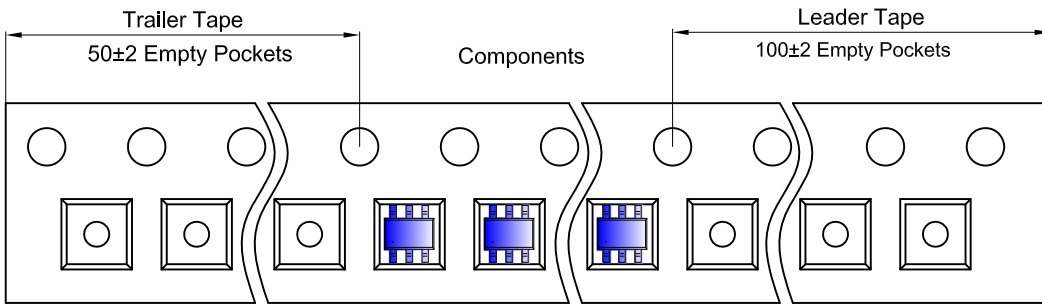

## SOT-363 Reel

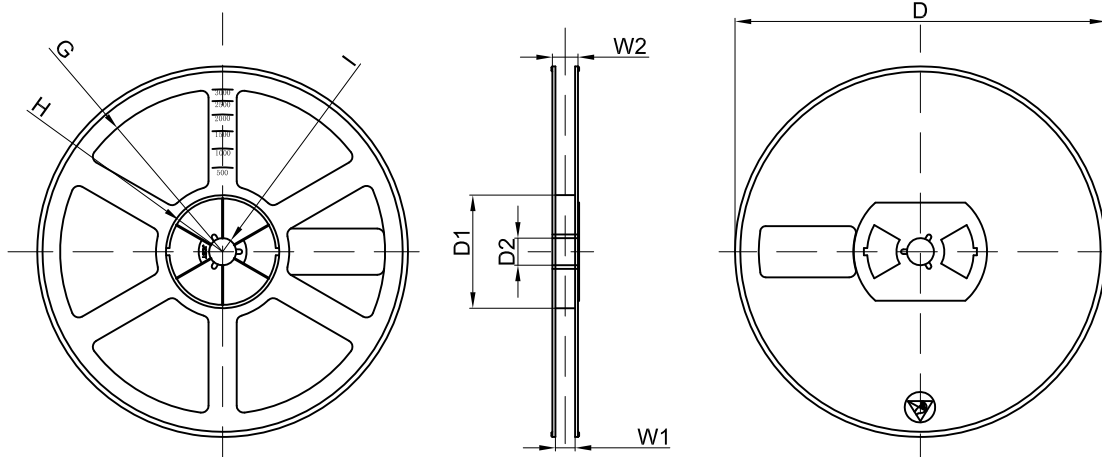

Dimensions are in millimeter								
Reel Option	D	D1	D2	G	H	I	W1	W2
7"Dia	Ø178.00	54.40	13.00	R78.00	R25.60	R6.50	9.50	12.30

REEL	Reel Size	Box	Box Size(mm)	Carton	Carton Size(mm)	G.W.(kg)
3000 pcs	7 inch	45,000 pcs	203×203×195	180,000 pcs	438×438×220	