

# PRODUCT SPECIFICATION

新弘智

SPEC. NO: T-0653-009N

DATE: Aug.7,2018

CUSTOMER'S PRODUCT NAME:

EMTEK PRODUCT NAME:

PHC0420-Series

THIS SPECIFICATION IS:

- FULLY ACCEPTED  
 DENIED  
 ACCEPTED UNDER THE FOLLOWING CONDITIONS



SIGNATURE: \_\_\_\_\_ DATE: \_\_\_\_\_

NAME(PRINT): \_\_\_\_\_

TITLE: \_\_\_\_\_

 **EMTEK CO., LTD.**

本文件內容全部或部份,未經兆欣科技股份有限公司同意不得以任何形式複製或其他用途  
All rights reserved.This document or parts thereof,may not be reproduced by any means or used in any manner without written permission of EMTEK CO.,LTD.

FACTORY:  
39,Chingao Rd.,(305)Hsinpu,  
Hsinchu Hsien,Taiwan,R.O.C  
TEL: 03-5894-433  
FAX: 03-5894-523

# PRODUCT SPECIFICATION

SPEC. No.

T-0653-009N



## 1. Scope

This specification applies High Current Power Inductors PHC0420-Series to be delivered to user.

## 2. Product Identification

PHC 0420 - 1R5 □ - T

(1) (2) (3) (4) (5)

(1) Product name

(2) Shapes and dimensions

(3) Inductance

1R5: 1.5 $\mu$ H

(4) Tolerance(%)

M:  $\pm 20\%$

(5) Taping Type

T: Taping, None: Bulk

## 3. Shapes and Dimensions

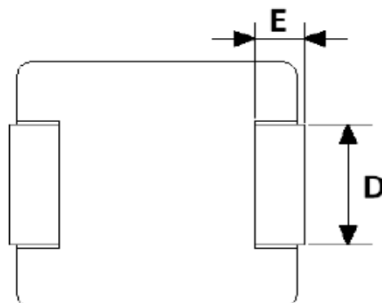
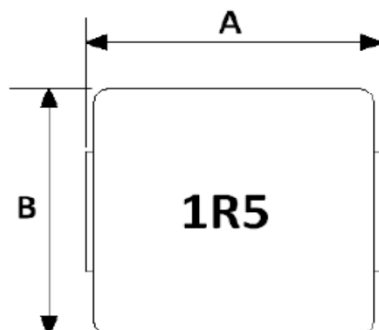

A : 4.45 $\pm$ 0.25 mm

B : 4.06 $\pm$ 0.25 mm

C : 2.0 Max. mm

D : 2.0 $\pm$ 0.3 mm

E : 0.76 $\pm$ 0.3 mm



Drawn by	Checked by	Approved by
Cindy Feb.15.2017	hsin Feb.15.2017	Dragon Feb.15.2017

# PRODUCT SPECIFICATION

SPEC. No.

T-0653-009N



## 4. Schematics and Land Patterns

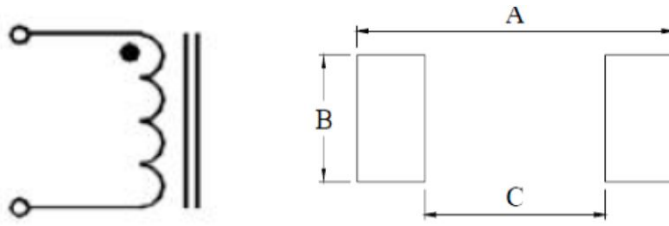

A	4.95 mm
B	2.35 mm
C	1.65 mm

## 5. Electrical Characteristics

### 5-1 Electrical Spec.

Customer Part Number	EMTEK Part No.	Inductance $\mu$ H (100KHz/0.5V)	Tol.	Rdc (m $\Omega$ )		Heat Rating Current DC Amps.Idc(A)	Saturation Current DC Amps. Isat(A)
				Typ.	Max.		
	PHC0420-R10□-T	0.10	M	7	9	10.5	15.0
	PHC0420-R22□-T	0.22	M	9	11	9.2	12.0
	PHC0420-R33□-T	0.33	M	11	14	7.6	10.0
	PHC0420-R47□-T	0.47	M	15	18	6.8	9.0
	PHC0420-R68□-T	0.68	M	19	21	5.2	8.0
	PHC0420-1R0□-T	1.0	M	24	27	4.5	7.0
	PHC0420-1R2□-T	1.2	M	24	27	4.5	7.0
	PHC0420-1R5□-T	1.5	M	38	46	4.0	6.0
	PHC0420-2R2□-T	2.2	M	52	58	3.0	5.0
	PHC0420-3R3□-T	3.3	M	74	87	2.5	4.0
	PHC0420-4R7□-T	4.7	M	92	105	2.2	3.0
	PHC0420-5R6□-T	5.6	M	128	150	2.3	2.1
	PHC0420-6R8□-T	6.8	M	162	178	2.0	2.1
	PHC0420-8R2□-T	8.2	M	188	207	1.8	2.0
	PHC0420-100□-T	10.0	M	256	282	1.6	1.8

# PRODUCT SPECIFICATION

SPEC. No.

T-0653-009N



Inductance Tolerance: M=±20% , N=±30%

1. All test data is referenced to 25°C ambient.
2. I<sub>dc</sub> : DC current (A) that will cause an approximate  $\Delta T$  of 40°C
3. I<sub>sat</sub> : DC current (A) that will cause L<sub>o</sub> to drop approximately 30%
4. Operating Temperature Range -40°C to + 125°C
5. The part temperature (ambient + temp rise ) should not exceed 125°C under worst case operating conditions. Circuit design , component placement, PWB trace size and thickness, airflow and other cooling provision all affect the part temperature. Part temperature should be verified in the end application.
6. The rated current as listed is either the saturation current or the heating current depending on which value is lower.
7. TEST FREQUENCY: 100KHz, 0.5V  
TESTING INSTRUMENT L: Agilent/HP4284A Precision LCR Meter.  
R<sub>dc</sub>: Chroma Millohmeter 16502 or equivalent.
8. The moisture sensitivity level (MSL) of products is level 2.

# PRODUCT SPECIFICATION

SPEC. No.

T-0653-009N



## 5-2 Typical Electrical Curve : Inductance VS Isat , Irms VS TEMP.

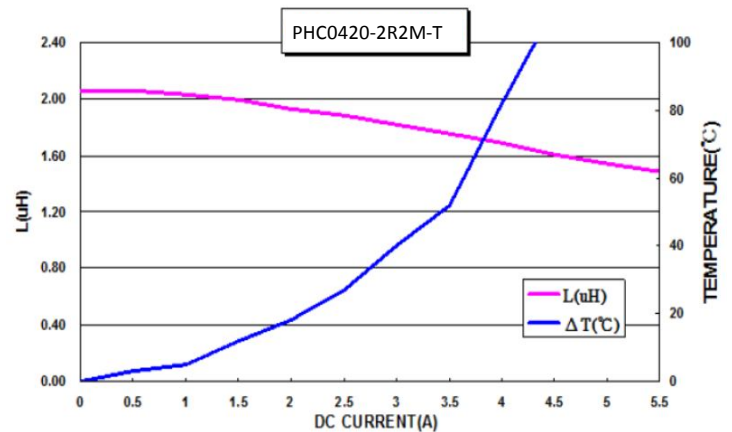
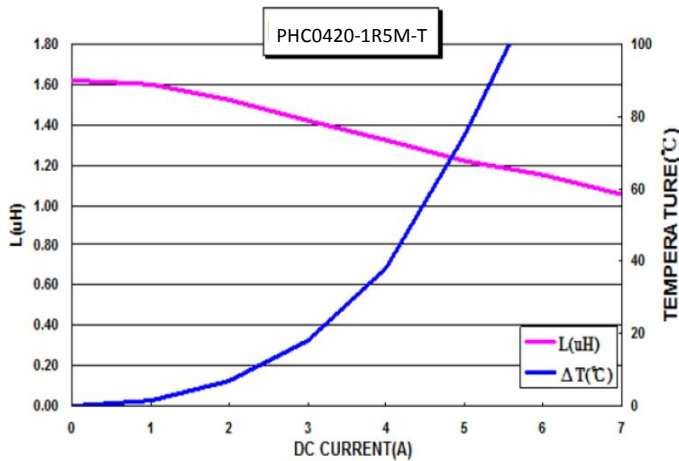
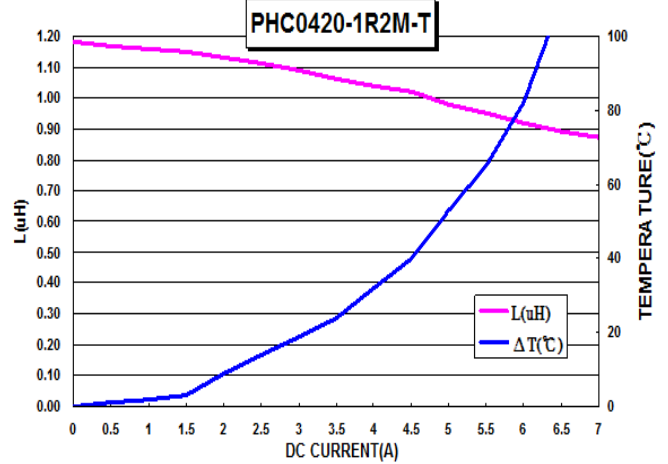
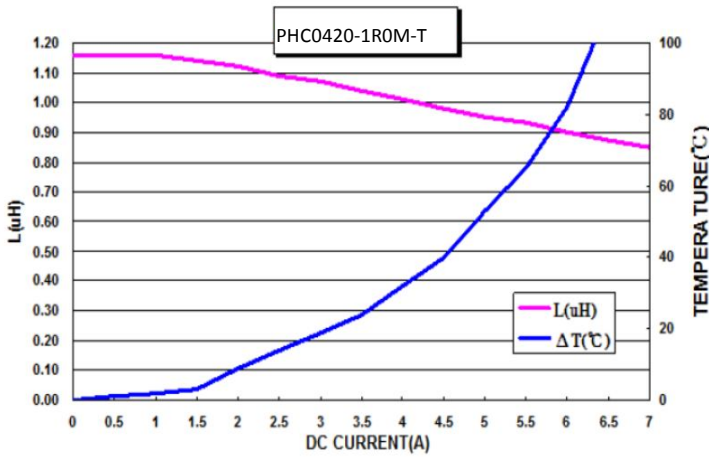
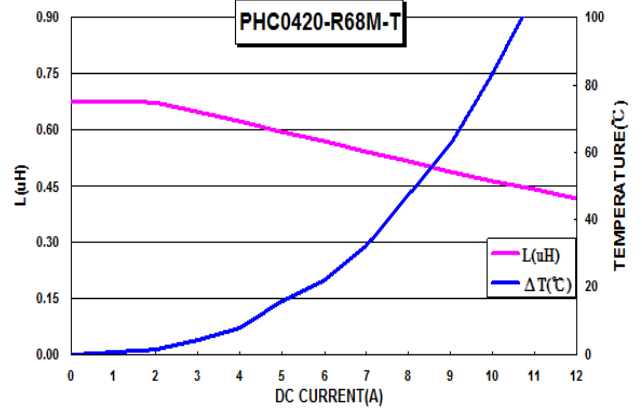
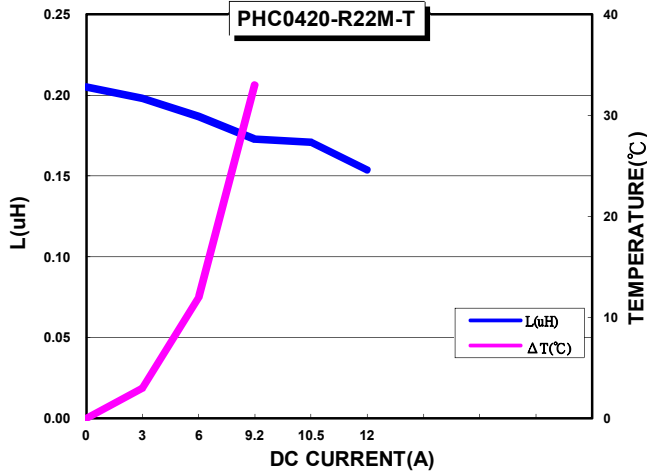

# PRODUCT SPECIFICATION

SPEC. No.

T-0653-009N



## 5-2 Typical Electrical Curve : Inductance VS Isat , Irms VS TEMP.

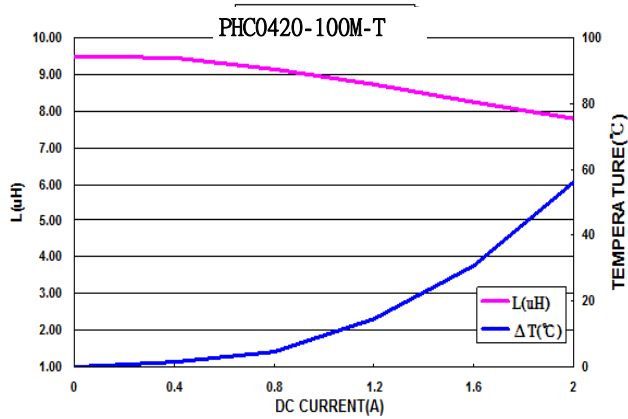
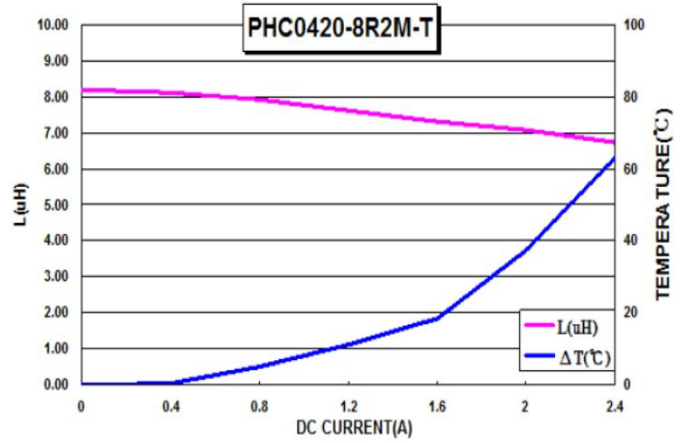
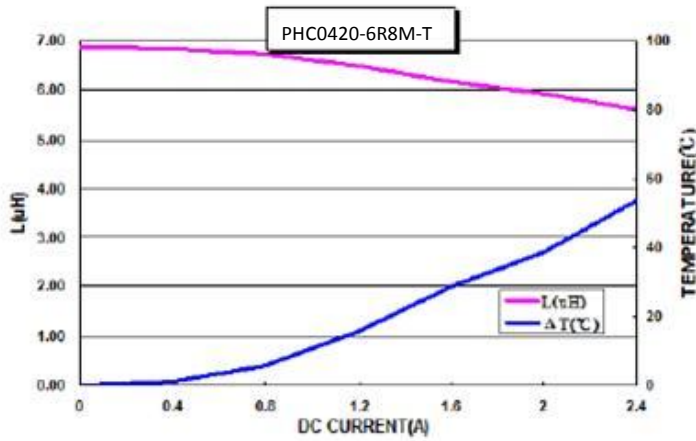
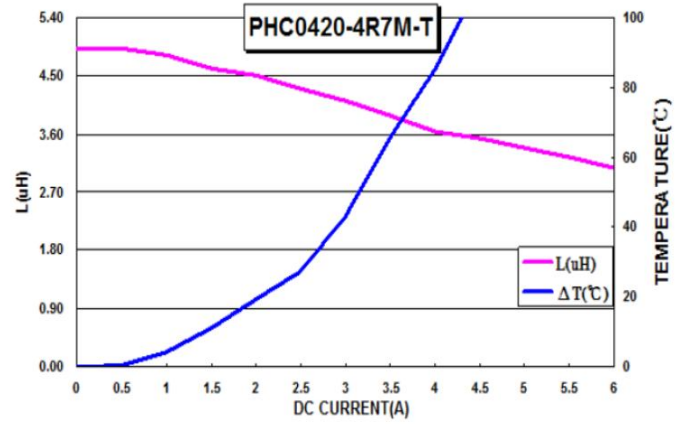
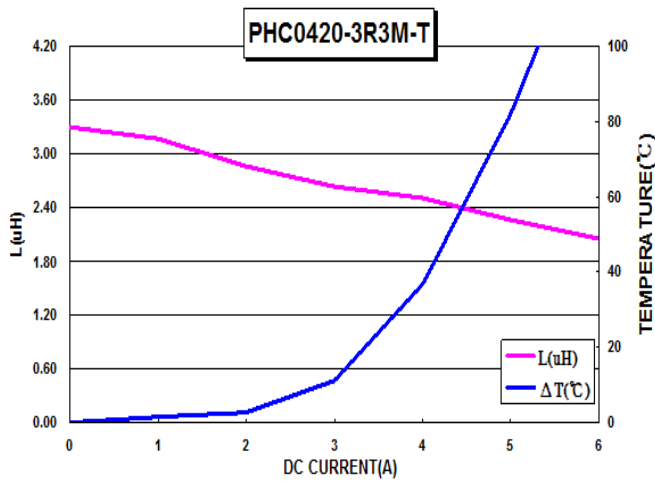

# PRODUCT SPECIFICATION

SPEC. NO.

T-0653-009N



## 6. Reliability Test

Item	Specifications	Test conditions
Solderability	The metalized area must have 90% minimum solder coverage.	Dip pads in flux and dip in solder pot( 96.5 Sn/3.5 Ag solder) at 255°C ±5°C.
Resistance to soldering heat	There must be no case deformation or change in dimensions. Inductance must not change more than the stated tolerance.	Inductors shall be reflowed onto a PC board using 96.5 Sn/3.5 Ag solder paste. Solder process shall be at a maximum temperature of 260°C. For 96.5 Sn/3.5 Ag solder paste:>217°C for 90 seconds
High temperature resistance	There must be no case deformation or change in dimensions. Inductance must not change more than the stated tolerance.	Inductors shall be subjected to temperature 125±2°C for 100 hours. Measure the test items after leaving the inductors at room temperature and humidity for 2 hours.
Static Humidity	Inductors must not have a shorted or openwinding.	Inductors shall be subjected to temperature 85±2°C and 90 to 95%RH. for 100 hours. Measure the test items after leaving the inductors at room temperature and humidity for 2 hours.
Low temperature resistance	There must be no case deformation or change in dimensions. Inductance must not change more than the stated tolerance.	Inductors shall be subjected to temperature -40±2°C for 100 hours. Measure the test items after leaving the inductors at room temperature and humidity for 1 to 2 hours.
Temperaure cycle	Change from an initial value Inductance: within ±10%	The specimen shall be subjected to 10 continuous cycles of temperature change of -40°C for 30 min and 125°C for 30 min with the transit period of 3 min or less. Then it shall be stabilized under standard atmospheric conditions for 1 hr before measurement.

# PRODUCT SPECIFICATION

SPEC. NO.

T-0653-009N



## 7. Packaging

The packaging must be done not to receive any damage during transporting and storing.

### 7-1 Tape dimensions

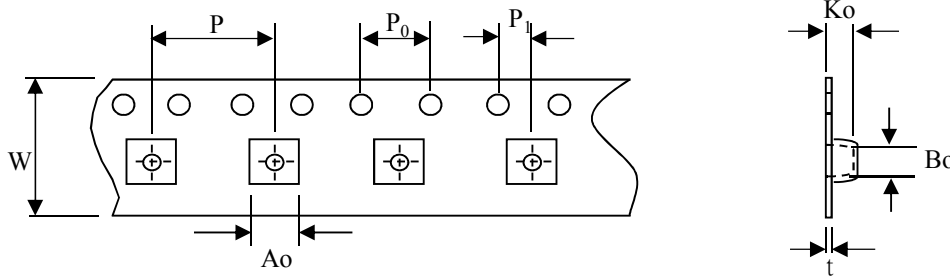

(Dimensions in mm; Tolerance :  $\pm 0.1$ )

Symbol	W	P	P <sub>0</sub>	P <sub>1</sub>	A <sub>o</sub>	B <sub>o</sub>	K <sub>o</sub>	t
Dimension	12	8	4	2	4.55	4.75	2.4	0.25 $\pm$ 0.05

### 7-2 Reel dimensions

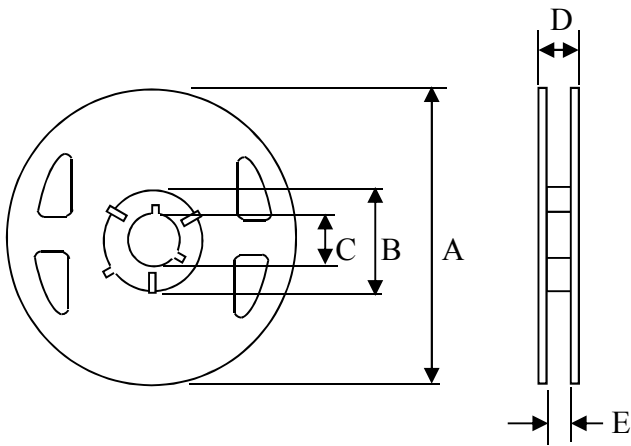

(Dimensions in mm)

Symbol	T
A	180
B	60
C	13
D	16
E	13.2

### 7-3 Tapping figure

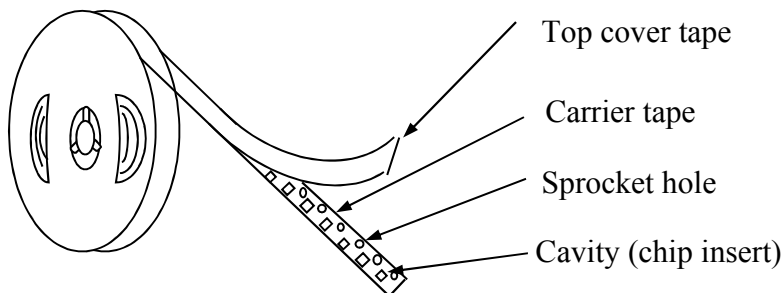



# PRODUCT SPECIFICATION

SPEC. NO.

T-0653-009N



## 7-4 Packaging Form

There shall not continuation more than two vacancies of the product.

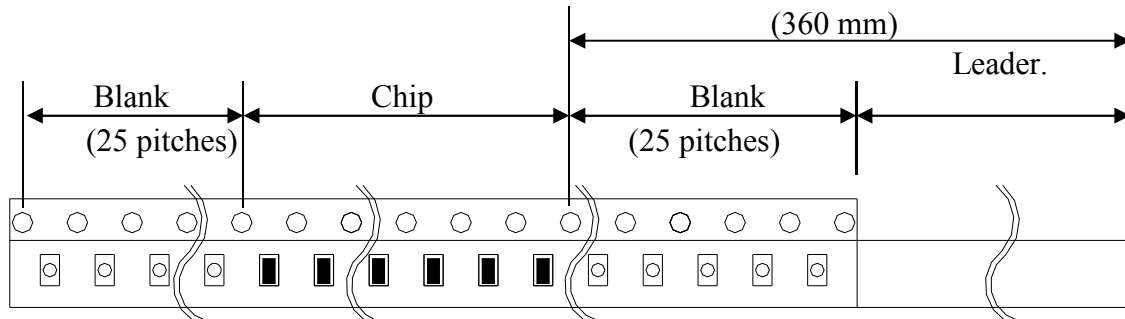

## 7-5 Cover Tape Peel Strength

The force for tearing off cover tape is 0.1~0.6(N) in the arrow direction at the following conditions:

Temperature : 5 ~ 35°C

Humidity : 45 ~ 85%

Atmospheric pressure : 860 ~ 1060 hpa

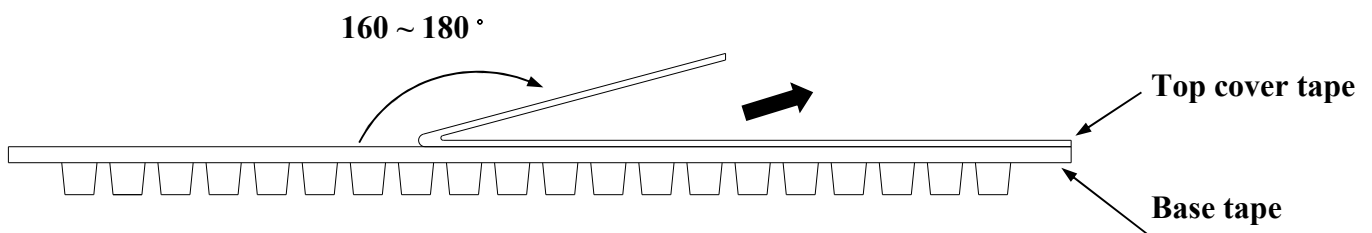

## 7-6 Packing Quantity

φ180 mm reel type : 500 pcs./reel

# PRODUCT SPECIFICATION

SPEC. NO.

T-0653-009N



## 8. Recommended Reflow Pattern

### 8-1 Recommended Reflow Pattern

Reflow : until two times

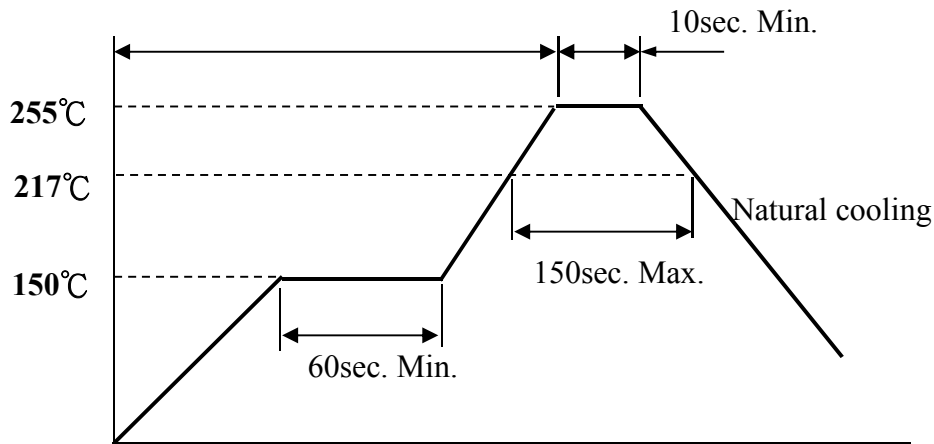

### 8-2 Iron Soldering

Use a solder iron of less than 30W when soldering, do not allow the soldering iron tip directly touch the Ceramic body outside of terminal electrode.

5 seconds max. at 260°C.

## 9. Attention in Case of Using

In case of using product, please avoid following matters:

Splashing water or salt water

Dew condenses

Toxic gas (Hydrogen sulfide, Sulfurous acid, Chlorine, Ammonia)

Vibrations or shocks which exceed the specified condition

Please be careful for the stress to this product by board flexure or something after the mounting.

## 10. Others

10-1 Operating temperature range : Ferrite Series :-40~+125°C

10-2 Storage condition : Temperature 20°~25°C , Relative Humidity 40%~60%

10-3 Recommended wire wound inductors should be used within 6 months from the time of delivery.