

# 2017 火炬电子产品选型指南

TORCH ELECTRONIC  
PRODUCT SELECTION GUIDE



· 点 燃 思 想 ·

# 公司简介

company profile



福建火炬电子科技股份有限公司始创于1989年，系国家级高新技术企业、福建省“十一五”规划电子元器件发展支柱企业、福建省第二批创新型企业，有5家全资子公司及1家控股子公司。公司于2015年元月在上海证券交易所上市，股票代码：603678。

1990年火炬推出了国内首颗超小型独石电容，2006年成功研制首颗国产宇航级电容，火炬牌产品以技术、质量和服务享誉市场，被称为“电容专家”，参与陶瓷电容器国家标准、行业标准的制定。火炬为用户提供免费样品、选型支持、产品分析检测和辅助设计等技术服务，并以完善质量控制和库存物流系统，实现最为快捷的订购服务。目前火炬在国内拥有4000多家企业用户，主要分布在通讯、电力、医疗设备、工业控制、汽车电子及航空航天等领域。

秉承“诚·信·专·精”之理念，火炬努力成为最优秀的无源元件供应商，我们竭诚欢迎新老用户来火炬参观指导、洽谈合作！





- 证书名称: 社会责任管理体系认证证书 (SA8000:2008)
- 证书编号: IND13.7881
- 发证时间: 2010年12月14日
- 发证单位: BUREAU VERITAS CERTIFICATION
- 认证范围: 多层瓷介电容器的设计、生产和销售



- 证书名称: 环境管理体系认证证书 (ISO14001:2004)
- 证书编号: 01414E10212R3M
- 发证时间: 2014年12月8日
- 发证单位: 中联认证中心
- 认证范围: 多层瓷介电容器的设计、生产和相关管理活动



- 证书名称: 质量管理体系认证证书 (ISO9001:2008)
- 证书编号: 01214Q20840R1M
- 发证时间: 2014年12月22日
- 发证单位: 广州赛宝认证中心
- 认证范围: 电容器用陶瓷材料及多层瓷介电容器的设计、生产和服务



- 证书名称: 职业健康安全管理体系认证证书 (OHSAS18001:2007)
- 证书编号: 01414S10128R3M
- 发证时间: 2014年12月8日
- 发证单位: 中联认证中心
- 认证范围: 多层瓷介电容器的设计、生产和相关管理活动



- 证书名称: 中国合格评定国家认可委员会实验室认可证书
- 证书编号: CNAS L2772
- 发证时间: 2014年8月4日
- 发证单位: 中国合格评定国家认可委员会
- 认可范围: GJB4157-2001 《高可靠瓷介固定电容器总规范》  
GJB192A-1998 《有可靠性指标的无封装多层片式瓷介电容器总规范》  
GB/T2693-2001 《电子设备用固定电容器 第一部分: 总规范》及其它

# 目录

## TORCH CIVILIAN PRODUCTS

- 02 公司简介
- 06 陶瓷电容器应用指南
- 13 片式多层瓷介电容器
- 21 加严型片式多层瓷介电容器
- 27 引线式多层瓷介电容器
- 33 加严型引线式多层瓷介电容器
- 39 片式高压多层瓷介电容器
- 43 模压表贴瓷介电容器
- 47 片式固体钽电容器
- 53 片式固定电阻器
- 57 多层瓷介固定电容器检验规范Q/HJ5998B
- 免费样品联络单



# 陶 瓷 电 容 器 应 用 指 南

电容器的可靠性不仅取决于电容器固有的可靠性，而且还取决于电容器的使用可靠性；为了让设计者做到正确的选型与合理的使用，达到产品预定的用途和可靠性，特编写《陶瓷电容器应用指南》以供选型参考！

## 一 技术信息

### 1 工作温度

电容器工作温度应在产品的类别温度范围内；上限类别温度采用降额使用，可延长电容器的工作寿命，通常推荐电容器的工作温度限制在低于上限类别温度 $10^{\circ}\text{C}\sim 15^{\circ}\text{C}$ 。

### 2 工作电压

电容器工作电压（直流电压与交流电压之和）不应超过额定电压，额定电压采用降额使用，可延长电容器的工作寿命，根据电容器的不同应用场合，通常推荐额定电压降额使用如下：

- 一般场合应用中，按70%的额定电压（Ⅲ级）降额使用；
- 在军用场合或重要、关键电路等应用中，按50%的额定电压（Ⅰ级）或按60%的额定电压（Ⅱ级）降额使用；
- 在大功率、低阻抗电路中使用，按30%的额定电压降额使用，以免直流浪涌电流冲击而造成电容器的损坏。

### 3 工作频率

- 电容器应工作在远低于电容器的自谐振频率 $f_0$ 的频率范围内以保证电容器呈容性；
- 通常应用频率 $1\text{kHz}\sim 10\text{MHz}$ 选用2类瓷介电容器； $10\text{MHz}\sim 300\text{MHz}$ 频率选用1类瓷介电容器。

### 4 电容量选择

设计者在选用电容量时，除满足电路的要求外，应优先选用标准中规定的优选数系：1类瓷介电容器 $0.01\mu\text{F}$ 以下推荐按E24系列，大于 $0.01\mu\text{F}$ 推荐按E12系列；2类瓷介电容器 $0.01\mu\text{F}$ 以上推荐按E12或E6系列，大容量电容器（ $1\mu\text{F}$ 以上）推荐按E6或E3系列。

#### 标称电容量优选系列

E3系列	1.0				2.2					4.7														
E6系列	1.0		1.5		2.2		3.3		4.7		6.8													
E12系列	1.0	1.2	1.5	1.8	2.2	2.7	3.3	3.9	4.7	5.6	6.8	8.2												
E24系列	1.0	1.1	1.2	1.3	1.5	1.6	1.8	2.0	2.2	2.4	2.7	3.0	3.3	3.6	3.9	4.3	4.7	5.1	5.6	6.2	6.8	7.5	8.2	9.1

注：优选系列之外的规格属于非标产品，供货周期较长，成本相对也高

### 5 质量等级

定义：指电容器在装机之前，按产品的执行标准或供需双方的技术协议，在制造、试验以及筛选过程中质量的控制等级。对产品采用不同的技术标准和管理方法组织生产，其质量等级也随之不同，同时也直接影响到电容器的成本构成。电容器设计选型前应首先索取产品的详细规范，了解产品的质量等级以满足设备和线路的可靠性要求。

### 6 替代使用

电容器选用时允许按使用要求“以高代低”，以减少电容器的规格数量，方便采购、仓库管理和现场使用，从而降低管理成本。如以额定电压高的代替额定电压低的，以容量精度高的代替精度低的，以容量随电压、温度变化率小的代替变化率大的；如成本允许也可以考虑高质量等级替代低质量等级，以1类瓷介电容器代替2类瓷介电容器。

### 7 电容器老化特性

2类瓷介电容器由于介质特性所致，电容量会随着放置时间的延长而缓慢减小，通常将这现象称为“2类瓷介电容器电容量老化”现象，电容器老化现象是可预测的，是可重复的（即可通过电容器的去老化，使电容器容量恢复至初始状态）。

### 8 电容器去老化

a) 电容器因储存时间长或受过老化筛选试验后，对电容量进行检测时，需预先进行电容器去老化处理；即将电容器加热至高于居里温度的某一温度，电容器的老化现象消失；当电容器再次冷却时，老化会重新开始。一般去老化的方法：在温度 $150^{\circ}\text{C}$ 下，不施加电压放置1h，在 $25^{\circ}\text{C}$ 下恢复 $24\pm 2\text{h}$ 进行电容量测试，这时的电容量最接近出厂的状态。

注：产品包装材料不耐高温，去老化操作前应去除。

b) 电容器被安装到设备后，如果长期处于未通电状态，电容器也会有老化现象，即电容量会缓慢减小。火炬电子通过长期跟踪研究和试验得出：当设备在开机通电的瞬间，电容器在电源电场的作用下，其陶瓷介质的偶极子因放置时间的延长而发生偏转的部分会瞬间被扭正，即极性排列状态将接近该电容器出厂时的状态，电容量会一定程度的得以恢复。



## 9 贮存条件

陶瓷电容器贮存环境要求：温度范围-10℃~40℃，有条件应将温度范围控制在-5℃~30℃；相对湿度小于70%RH；周围无氯、硫磺之类腐蚀性物质；保持电容器原包装有助于保护产品，在使用前方可打开；电容器贮存时间超过一年，要重新进行可焊性检测，可焊性指标合格可继续使用。

## 10 典型曲线

CG 温度特性曲线  
Temperature Coefficient

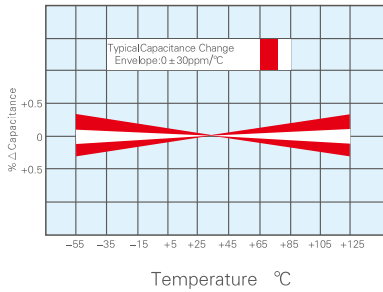

CG 频率特性曲线  
Capacitance vs.Frequency

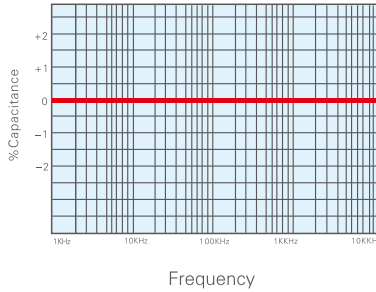

CG 损耗角正切曲线  
D.F.vs Temperature

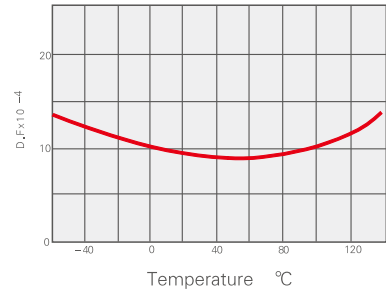

2X1 温度特性曲线  
Temperature Coefficient

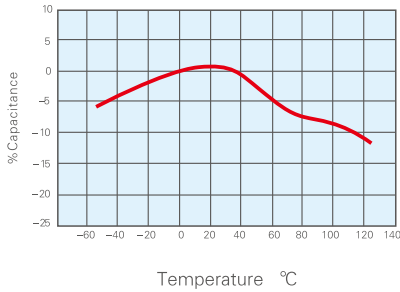

2X1 频率特性曲线  
Capacitance vs.Frequency

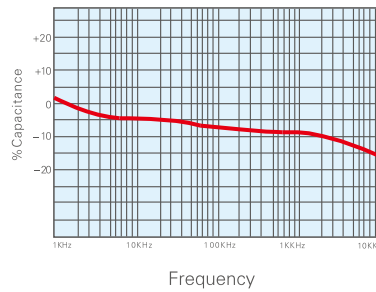

2X1 损耗角正切曲线  
D.F.vs Temperature

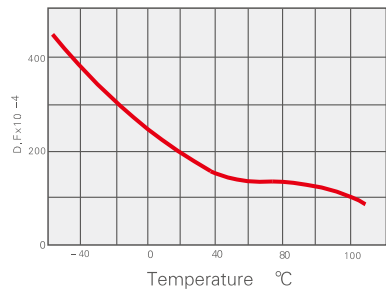

X5R 温度特性曲线  
Temperature Coefficient

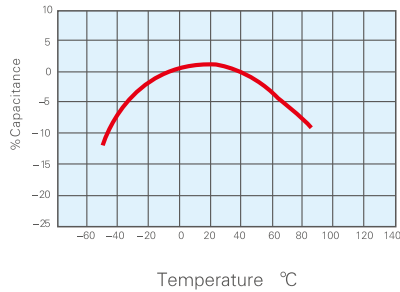

X5R 频率特性曲线  
Capacitance vs.Frequency

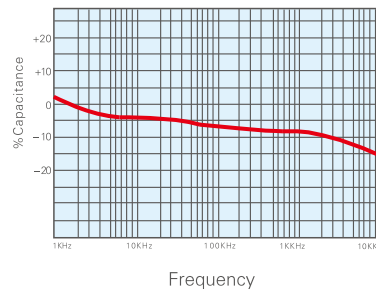

X5R 损耗角正切曲线  
D.F.vs Temperature

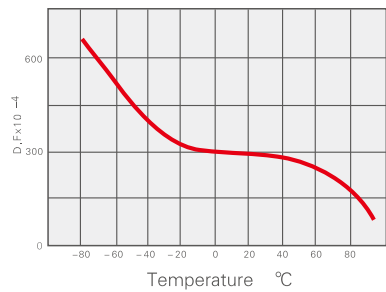

2F4 温度特性曲线  
Temperature Coefficient

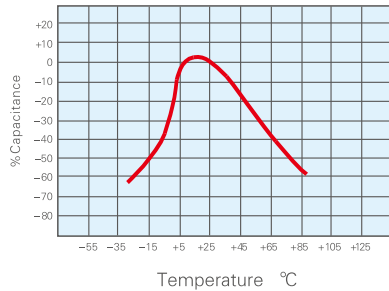

2F4 电压特性曲线  
Capacitance Change vs.DC Bias Voltage

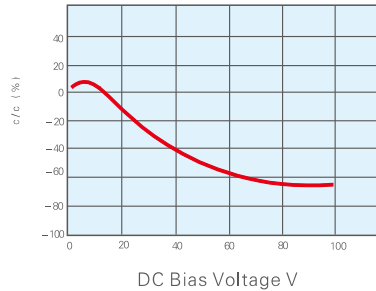

2F4 损耗角正切曲线  
D.F.vs Temperature

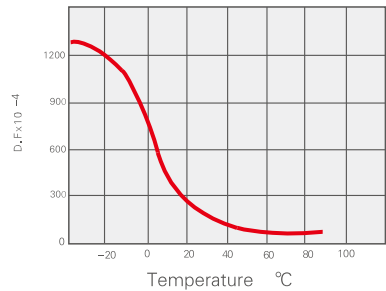

## 二 电装工艺

### 1 推荐安装方式

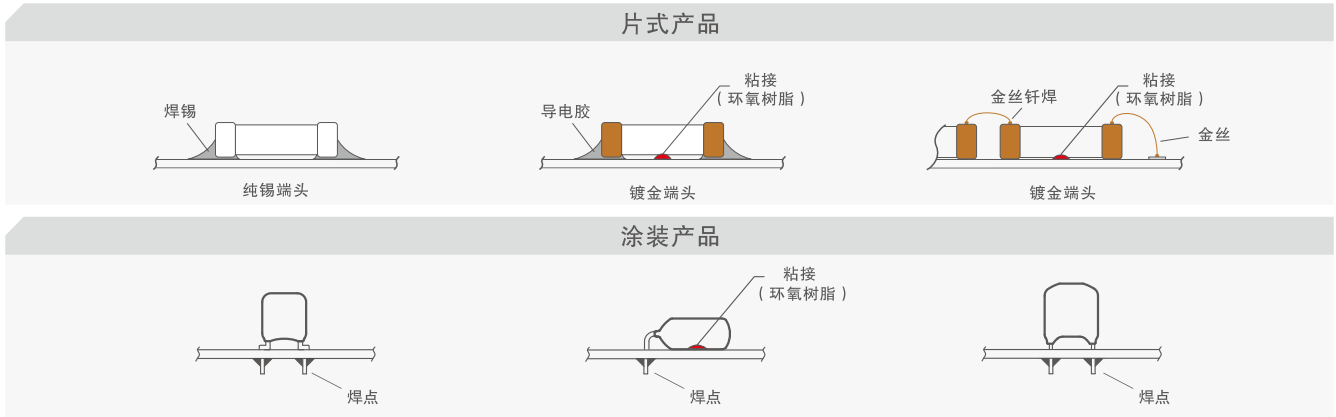

### 2 可选焊接方式(片式产品)

- (1) 载流焊 (汽相、远红外线、热板)
- (2) 波峰焊 (1210以上大规格产品不宜采用波峰焊)
- (3) 手工焊 (1210以上大规格产品应该特别注意避免热冲击)

### 3 推荐焊接温度曲线

特别提示：预热时间必须保证大于2分钟，否则电容器易因受热不均造成损坏或损伤（即容易造成热冲击故障）

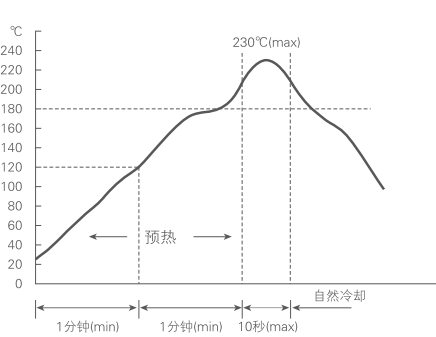

含铅产品载流焊推荐温度曲线

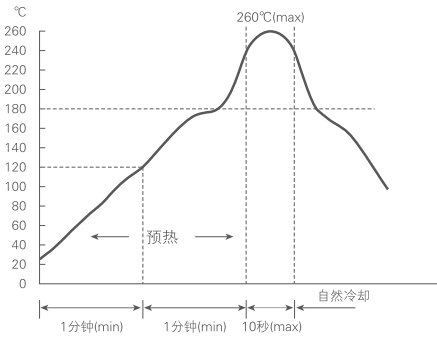

无铅产品载流焊推荐温度曲线

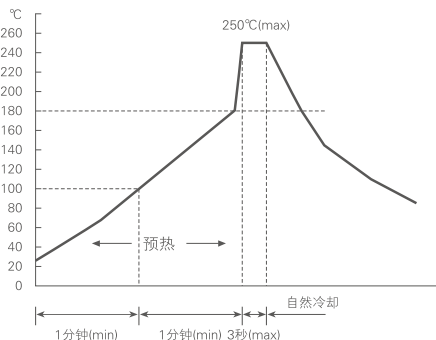

含铅产品波峰焊推荐温度曲线

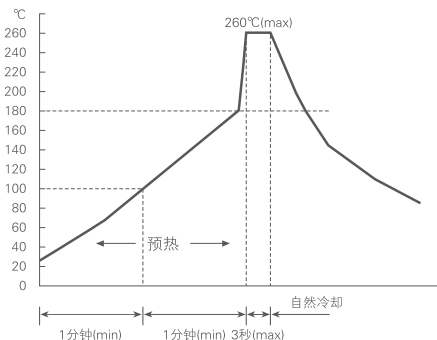

无铅产品波峰焊推荐温度曲线



## 4 焊盘推荐

### 无封装片式电容器

载流焊接焊盘尺寸

单位: mm

外形尺寸	Z		G		X		Y		C	
	min	max	min	max	min	max	min	max	min	max
0201	0.60	0.90	0.20	0.30	0.25	0.40	0.20	0.30	0.40	0.60
0402	1.00	1.60	0.40	0.60	0.40	0.60	0.30	0.50	0.70	1.10
0603	1.70	2.60	0.50	1.00	0.60	1.00	0.60	0.80	1.10	1.80
0805	2.00	3.80	0.60	1.20	0.90	1.60	0.70	1.30	1.30	2.50
1206	3.80	5.70	1.80	2.50	1.20	2.00	1.00	1.60	2.80	4.10
1210	3.80	5.70	1.80	2.50	1.80	3.20	1.00	1.60	2.80	4.10
1812	4.90	7.50	2.50	3.70	2.30	3.50	1.20	1.90	3.70	5.60
2220	5.60	9.30	3.20	4.70	3.50	5.00	1.20	2.30	4.40	7.00
2225	5.60	9.30	3.20	4.70	3.50	6.80	1.20	2.30	4.40	7.00

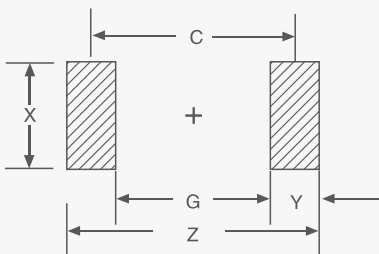

波峰焊接焊盘尺寸

单位: mm

外形尺寸	Z		G		X		Y		C	
	min	max	min	max	min	max	min	max	min	max
0603	1.70	2.60	0.50	1.00	0.60	1.00	0.60	0.80	1.10	1.80
0805	2.00	3.80	0.60	1.20	0.90	1.60	0.70	1.30	1.30	2.50
1206	3.80	5.70	1.80	2.50	1.20	2.00	1.00	1.60	2.80	4.10
1210	3.80	5.70	1.80	2.50	1.80	3.20	1.00	1.60	2.80	4.10

\*0201、0402、1812、2220、2225尺寸不推荐使用波峰焊

备注: 上表所列焊盘尺寸意为为电路设计者提供一个基本参考依据; 如果需要, 可根据焊接过程状况和电路设计的具体情况作微调。

## 5 片式产品的手工焊接

- (1) 焊接前，先将电容器和基板逐渐预热至100℃~125℃；
- (2) 手工焊一般选用功率20W的电烙铁为宜，烙铁头直径不超过3mm，烙铁头尖端不大于1mm；
- (3) 焊接非接地焊盘时，焊接温度一般设置为260℃~280℃，焊接接地焊盘时，焊接温度一般设置280℃~300℃，焊接时间不超过3s；
- (4) 烙铁头不允许碰触电容器本体，电容器的一端焊后发现电容器翘起不平，必须将原焊点熔开后方可整平，切勿以烙铁头在电容器上直接加热整平(见图1、图2)；
- (5) 焊接后自然冷却，请勿风冷；急热、急冷均容易造成裂痕或损伤；
- (6) 推荐使用环保型免清洗焊料、助焊剂；
- (7) 特别提醒：电容器与基板之间的多余杂质会形成跨接电阻，影响电容器性能(见图3)。



图1



图2

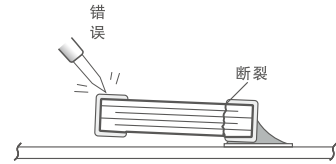

图3

## 6 避免事例

- (1) 贴装完成的基板弯曲时，由于陶瓷电容器性脆、韧性低、耐弯曲能力差，电容器瓷体容易断裂(见图4)

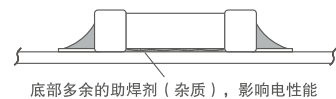

图4

- (2) 贴片机吸嘴的吸点过低，会因压力过大造成电容器破损，应注意根据电容器片体厚度及时设定恰当的下止点吸嘴处的压力静荷重应小于3N(见图5)

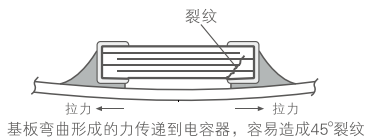

图5

- (3) 当陶瓷电容器本体局部受到急冷或急热时，由于冷热部位的膨胀状况不一致，将产生不良的内应力，导致电容器瓷体局部崩裂，这种崩裂现象多见为弧形裂痕，业界称为热冲击(详见图6、图7)



图6

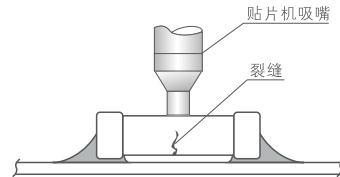

图7

- (4) 严格禁止片式无包封产品二次拆装使用
- (5) 片式无包封产品不建议补焊
- (6) 严格禁止片式无包封产品上下叠放焊接使用
- (7) 焊料过多，焊料冷却固化产生的收缩力作用于电容器，容易造成电容器端头拉裂、脱落；焊料过少，端头固着力不足产品容易脱落

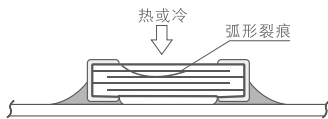

(8) 基板分割时，分割线边缘处所受的机械负荷压力最大，设计时应尽量远离分隔线，以及选择平行布置，以尽量减小应力对电容器的影响

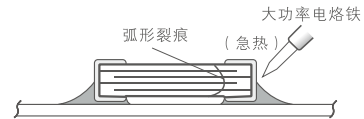
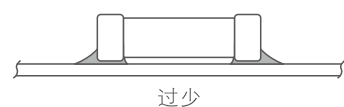
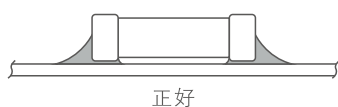
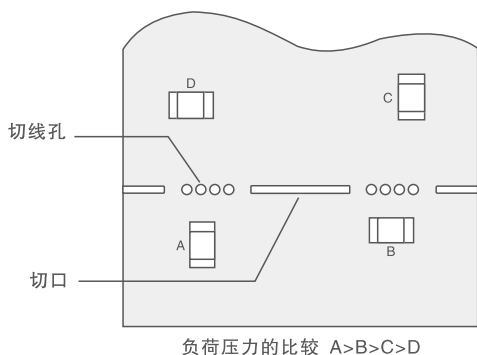

(9) 基板分割时，严禁徒手掰分基板，请用基板专用分割装置，并应正确调整支撑刀和切割刀的位置，避免出现上、下，左、右，前、后偏离

推荐	错误		
支撑刀	上下偏离	左右偏离	前后偏离
	支撑刀	支撑刀	支撑刀
切割刀	切割刀	切割刀	切割刀

(10) 电容器在搬运、移动时应避免激烈碰撞，从0.5米或以上高度落下后可能造成电容器瓷体破损或微裂，应禁止使用。

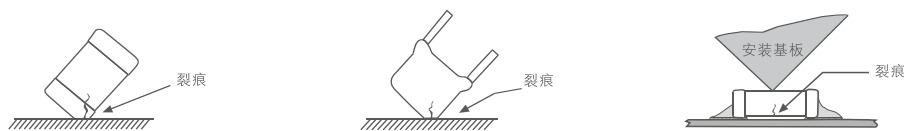

### 三 补充说明

本文内容仅涉及电容器应用的主要方面，其内容还有待以后继续补充和完善。欲获取更多资料，请联系火炬电子应用工程部；火炬电子应用工程部同时还免费提供辅助选型、故障分析、样品等技术服务。

请按以下方式联系：0595-22350265，22353697或 [ts@torch.cn](mailto:ts@torch.cn)。



片式多层瓷介电容器

# 片式多层瓷介电容器

CC41型、CT41型片式多层瓷介电容器

## 执行标准

总规范：GB/T 2693-2001《电子设备用固定电容器第1部分：总规范》  
分规范：GB/T 21041-2007《电子设备用固定电容器第21部分：分规范》  
GB/T 21042-2007《电子设备用固定电容器第22部分：分规范》



## 产品应用

CG：振荡器、混频器、中频/高频/甚高频/超高频放大器、低噪声放大器、时间电路、高频滤波电路、高频耦合。  
2X1、X5R：电源(滤波、旁路)电路、时间电路、储能电路、中频/低频放大器(隔直、耦合、阻抗匹配)，高频开关电源(S.P.S)、DC/DC变换器、滤波、旁路电路、隔直、阻抗匹配电路。  
2F4：电源滤波电路、隔直、阻抗匹配电路。

## 选用示例

CC41	0805	CG	50V	100pF	J	N	T
CT41	0805	2X1	50V	0.1 μF	K	N	T
型号	外形尺寸	温度特性	额定电压	标称容量	允许偏差	端头形式	包装方式
①	②	③	④	⑤	⑥	⑦	⑧

### ① 型号

CC41：1类片式多层瓷介电容器(CG)  
CT41：2类片式多层瓷介电容器(2X1、X5R、2F4)

### ② 外形尺寸：

单位：mm

外形轮廓图	0201	0402	0603	0805	1206	1210	1812	2220	2225
	L	0.60 ± 0.03	1.00 ± 0.20	1.60 ± 0.20	2.00 ± 0.20	3.20 ± 0.30	3.20 ± 0.30	4.50 ± 0.40	5.70 ± 0.50
	W	0.30 ± 0.03	0.50 ± 0.20	0.80 ± 0.20	1.25 ± 0.20	1.60 ± 0.30	2.50 ± 0.30	3.20 ± 0.30	5.00 ± 0.50
	T <sub>max</sub>	0.35	0.70	1.00	1.45	1.90	2.80	3.50	3.50
	t	0.15 ± 0.05	0.25 ± 0.10	0.35 ± 0.25	0.50 ± 0.25	0.50 ± 0.35	0.60 ± 0.30	0.90 ± 0.60	0.90 ± 0.60

注：厚度有特别要求的，请咨询火炬电子4008-878799

### ③ 温度特性

组别	CG	2X1	X5R	2F4
温度特性	(0 ± 30)ppm/°C	± 15%	± 15%	+30%~-80%
温度范围	-55°C~125°C	-55°C~125°C	-55°C~85°C	-30°C~85°C

### ④ 额定电压：直标法

4V 6.3V 10V 16V 25V  
35V 50V(63V) 100V 200V

### ⑤ 标称容量：

- 采用直标法表示标称容量  
例：0.5pF 100pF 1000pF 0.01 μF 0.1 μF
- 采用三位数表示法，前二位数有效数，第三位为“0”的个数，单位：pF  
例：0R5 = 0.5pF 5R0 = 5pF 7R5 = 7.5pF (P或R代表小数点)  
100 = 10pF 101 = 100pF 104 = 100000pF=0.1 μF

### ⑥ 允许偏差

组别	CG						2X1/X5R			2F4	
代码	B(特选)*	C*	D*	F(特选)	G(特选)	J	J(特选)	K	M	S	Z
允许偏差	±0.1pF	±0.25pF	±0.5pF	±1%	±2%	±5%	±5%	±10%	±20%	+50~-20%	+80~-20%

\*C<sub>n</sub> ≤ 10pF；特殊精度产品请咨询火炬电子应用工程部

# 片式多层瓷介电容器

CC41型、CT41型片式多层瓷介电容器



⑦ 端头形式: N=基体金属化-金属阻挡层-锡(无铅化)  
G=基体金属化-金属阻挡层-金

⑧ 包装方式: T=散装           1000只/包、500只/包  
F=纸编带盘装   4000只/盘   0603、0805、1206尺寸  
                          10000只/盘   0402尺寸  
                          15000只/盘   0201尺寸  
E=塑编带盘装    500只/盘   1210、2220、2225尺寸  
                          1000只/盘   1210、1812尺寸  
                          2000只/盘   0805、1206、1210、1812尺寸  
                          3000只/盘   0805、1206尺寸

## 电气参数

特性	损耗角正切( $C_R$ 单位: pF)	介质耐电压	25°C绝缘电阻( $C_R$ 单位: $\mu$ F)	类别温度范围
CG	$C_R \leq 30\text{pF}$ $\text{tg } \delta \leq \frac{1}{(400+20C_R)}$ $C_R > 30\text{pF}$ $\text{tg } \delta \leq 10 \times 10^{-4}$	2.5 $U_R$	$C_R \leq 0.01\mu\text{F}$ $IR \geq 10^4 \text{ M}\Omega$ $C_R > 0.01\mu\text{F}$ $IR \geq \frac{100}{C_R} \text{ M}\Omega$	-55°C~125°C
2X1	$4\text{V} \leq U_R < 16\text{V}$ $\text{tg } \delta \leq 1000 \times 10^{-4}$ $16\text{V} \leq U_R < 25\text{V}$ $\text{tg } \delta \leq 700 \times 10^{-4}$ $25\text{V} \leq U_R < 50\text{V}$ $\text{tg } \delta \leq 500 \times 10^{-4}$		$C_R \leq 0.025\mu\text{F}$ $IR \geq 4\text{G}\Omega$ $C_R > 0.025\mu\text{F}$ $IR \geq \frac{100}{C_R} \text{ M}\Omega$	-55°C~85°C
X5R	$U_R \geq 50\text{V}$ $\text{tg } \delta \leq 350 \times 10^{-4}$			-30°C~85°C
2F4	$10\text{V} \leq U_R < 16\text{V}$ $\text{tg } \delta \leq 1000 \times 10^{-4}$ $16\text{V} \leq U_R < 25\text{V}$ $\text{tg } \delta \leq 700 \times 10^{-4}$ $25\text{V} \leq U_R < 50\text{V}$ $\text{tg } \delta \leq 500 \times 10^{-4}$ $U_R \geq 50\text{V}$ $\text{tg } \delta \leq 500 \times 10^{-4}$			

注: 0603或0603以下尺寸的2X1、X5R、2F4产品, 或者容量大于等于1 $\mu$ F的2X1、X5R、2F4产品, 损耗角正切值 $\text{tg } \delta \leq 1000 \times 10^{-4}$



# 片式多层瓷介电容器

CC41型、CT41型片式多层瓷介电容器



## 容量范围

CC41型

外形尺寸	0201			0402			0603			0805			1206			1210			1812			2220				2225			
额定电压(V)	50	25	50	50	100	200	50	100	200	50	100	200	50	100	200	50	100	200	25	50	100	200	25	50	100	200			
cap (pF) 0.5 1.0																													
1.2 1.5																													
1.8 2.2																													
2.7 3.3																													
3.9 4.7																													
5.6 6.8																													
8.2																													
10																													
12																													
15																													
18																													
22																													
27																													
33																													
39																													
47																													
56																													
68																													
82																													
100																													
120																													
150																													
180																													
220																													
270																													
330																													
390																													
470																													
560																													
680																													
820																													
1000																													
1200																													
1500																													
1800																													
2200																													
2700																													
3300																													
3900																													
4700																													
5600																													
6800																													
8200																													
cap (μF) .010																													
.012																													
.015																													
.018																													
.022																													
.027																													
.033																													
.039																													
.047																													
.056																													
.068																													
.082																													
0.10																													
0.12																													
0.15																													
0.18																													
0.22																													
0.27																													
0.33																													
0.39																													
0.47																													

CG



# 片式多层瓷介电容器

CC41型、CT41型片式多层瓷介电容器



## 容量范围

### CT41型

外形尺寸	1210								1812								2220				2225			
	4	6.3	10	16	25	50	100	200	6.3	10	16	25	50	100	200	16	25	50	100	50	100	200		
cap (pF)																								
100																								
120																								
150																								
180																								
220																								
270																								
330																								
390																								
470																								
560																								
680																								
820																								
1000																								
1200																								
1500																								
1800																								
2200																								
2700																								
3300																								
3900																								
4700																								
5600																								
6800																								
8200																								
cap (μF)																								
.010																								
.012																								
.015																								
.018																								
.022																								
.027																								
.033																								
.039																								
.047																								
.056																								
.068																								
.082																								
.10																								
.12																								
.15																								
.18																								
.22																								
.27																								
.33																								
.39																								
.47																								
.56																								
.68																								
.82																								
1.0																								
1.5																								
2.2																								
3.3																								
4.7																								
6.8																								
10.0																								
22.0																								
33.0																								
47.0																								
100.0																								
150.0																								
220.0																								
330.0																								

2X1  
X5R

- 要了解最大容量及250V以上系列产品，请联络火炬电子。
- 外形尺寸的优选建议：相同的容量、耐压、精度，选用较小尺寸的规格，供货期短、价格较优。  
例：0805与1206规格同样能满足要求的，请选用0805规格；0603与0805规格同样能满足要求的，请选用0603规格。
- 厚度特殊要求，请咨询火炬电子4008-878799。

# 片式多层瓷介电容器

CC41型、CT41型片式多层瓷介电容器



## 容量范围

CT41型

外形尺寸	0603				0805				1206				1210				1812				2225			
额定电压(V)	10	16	25	50	10	16	25	50	10	16	25	50	10	16	25	50	10	16	25	50	10	16	25	50
cap (pF)																								
2200																								
2700																								
3300																								
3900																								
4700																								
5600																								
6800																								
8200																								
cap (μF)																								
.010																								
.012																								
.015																								
.018																								
.022																								
.027																								
.033																								
.039																								
.047																								
.056																								
.068																								
.082																								
.10																								
.12																								
.15																								
.18																								
.22																								
.27																								
.33																								
.39																								
.47																								
.56																								
.68																								
.82																								
1.0																								
1.2																								
1.5																								
1.8																								
2.2																								
2.7																								
3.3																								
3.9																								
4.7																								
5.6																								
6.8																								
8.2																								
10.0																								
12.0																								
15.0																								
18.0																								
22.0																								
47.0																								
100.0																								

2F4

- 要了解最大容量及更详细技术参数，请联络火炬电子。
- 外形尺寸的优选建议：相同的容量、耐压、精度，选用较小尺寸的规格，供货期短、价格较优。  
例：0805与1206规格同样能满足要求的，请选用0805规格；0603与0805规格同样能满足要求的，请选用0603规格。
- 厚度特殊要求，请咨询火炬电子4008-878799。



加严型片式多层瓷介电容器

# 加严型片式多层瓷介电容器

CT41G型片式多层瓷介电容器



## 执行标准

总规范: GB/T 2693-2001《电子设备用固定电容器第1部分:总规范》  
 分规范: GB/T 21041-2007《电子设备用固定电容器第21部分:分规范》  
 GB/T 21042-2007《电子设备用固定电容器第22部分:分规范》  
 加严产品规格书: Q/HJ 5999-2006



## 产品应用

2X1、X5R: 电源(滤波、旁路)电路、时间电路、储能电路、中频/低频放大器(隔直、耦合、阻抗匹配), 高频开关电源(S.P.S)、DC/DC变换器、滤波、旁路电路、隔直、阻抗匹配电路。

## 选用示例

CT41G	0805	2X1	50V	0.1 μF	K	N	T
型号	外形尺寸	温度特性	额定电压	标称容量	允许偏差	端头形式	包装方式
①	②	③	④	⑤	⑥	⑦	⑧

### ① 型号

CT41G: 加严型片式多层瓷介电容器(2X1、X5R)

### ② 外形尺寸:

单位: mm

外形轮廓图	0201	0402	0603	0805	1206	1210	1812	2220	2225
	L	0.60±0.03	1.00±0.20	1.60±0.20	2.00±0.20	3.20±0.30	3.20±0.30	4.50±0.40	5.70±0.50
	W	0.30±0.03	0.50±0.20	0.80±0.20	1.25±0.20	1.60±0.30	2.50±0.30	3.20±0.30	5.00±0.50
	T <sub>max</sub>	0.35	0.70	1.00	1.45	1.90	2.80	3.50	3.50
	t	0.15±0.05	0.25±0.10	0.35±0.25	0.50±0.25	0.50±0.35	0.60±0.30	0.90±0.60	0.90±0.60

注: 厚度有特别要求的, 请咨询火炬电子4008-878799

### ③ 温度特性

组别	2X1	X5R
温度特性	±15%	±15%
温度范围	-55°C~125°C	-55°C~85°C

### ④ 额定电压: 直标法

4V 6.3V 10V 16V 25V  
 35V 50V(63V) 100V 200V

### ⑤ 标称容量

■ 采用直标法表示标称容量

例: 0.5pF 100pF 1000pF 0.01 μF 0.1 μF

■ 采用三位数表示法, 前二位数有效数, 第三位为“0”的个数, 单位: pF

例: 0R5 = 0.5pF 5R0 = 5pF 7R5 = 7.5pF (P或R代表小数点)

100 = 10pF 101 = 100pF 104 = 100000pF=0.1 μF

### ⑥ 允许偏差

组别	2X1/X5R		
代码	J(特选)	K	M
允许偏差	±5%	±10%	±20%

注: 特殊精度产品请咨询火炬电子应用工程部

# 加严型片式多层瓷介电容器

CT41G型片式多层瓷介电容器



⑦ 端头形式: N=基体金属化-金属阻挡层-锡(无铅化)

G=基体金属化-金属阻挡层-金

- ⑧ 包装方式: T=散装            1000只/包、500只/包  
 F=纸编带盘装    4000只/盘    0603、0805、1206 尺寸  
                                  10000只/盘    0402尺寸  
                                  15000只/盘    0201尺寸  
 E=塑编带盘装    500只/盘    1210、2220、2225尺寸  
                                  1000只/盘    1210、1812尺寸  
                                  2000只/盘    0805、1206、1210、1812尺寸  
                                  3000只/盘    0805、1206尺寸

## 电气参数

C<sub>R</sub>单位: μF

特性	损耗角正切	介质耐电压	25℃绝缘电阻	类别温度范围
2X1	4V ≤ U <sub>R</sub> < 16V    tg δ ≤ 1000 × 10 <sup>-4</sup> 16V ≤ U <sub>R</sub> < 25V    tg δ ≤ 700 × 10 <sup>-4</sup> 25V ≤ U <sub>R</sub> < 50V    tg δ ≤ 500 × 10 <sup>-4</sup>	3.0U <sub>R</sub>	C <sub>R</sub> ≤ 0.025μF    IR ≥ 20GΩ C <sub>R</sub> > 0.025μF    IR ≥ $\frac{500}{C_R}$ MΩ	-55℃~125℃
X5R	U <sub>R</sub> ≥ 50V    tg δ ≤ 350 × 10 <sup>-4</sup>			-55℃~85℃

注: 0603或0603以下尺寸的2X1、X5R产品, 或者容量大于等于1μF的2X1、X5R产品, 损耗角正切值tg δ ≤ 1000×10<sup>-4</sup>  
 0201尺寸的2X1、X5R产品, 或者部分极限2X1、X5R产品, 绝缘电阻指标请以产品规格书为准或咨询火炬电子应用工程部





# 加严型片式多层瓷介电容器

CT41G型片式多层瓷介电容器



## 容量范围

CT41G型

外形尺寸	1210								1812								2220				2225			
	4	6.3	10	16	25	50	100	200	6.3	10	16	25	50	100	200	16	25	50	100	50	100	200		
cap (pF)																								
100																								
120																								
150																								
180																								
220																								
270																								
330																								
390																								
470																								
560																								
680																								
820																								
1000																								
1200																								
1500																								
1800																								
2200																								
2700																								
3300																								
3900																								
4700																								
5600																								
6800																								
8200																								
cap (μF)																								
.010																								
.012																								
.015																								
.018																								
.022																								
.027																								
.033																								
.039																								
.047																								
.056																								
.068																								
.082																								
.10																								
.12																								
.15																								
.18																								
.22																								
.27																								
.33																								
.39																								
.47																								
.56																								
.68																								
.82																								
1.0																								
1.5																								
2.2																								
3.3																								
4.7																								
6.8																								
10.0																								
22.0																								
33.0																								
47.0																								
100.0																								
150.0																								
220.0																								
330.0																								

2X1  
X5R

- 要了解最大容量及250V以上系列产品，请联络火炬电子。
- 外形尺寸的优选建议：相同的容量、耐压、精度，选用较小尺寸的规格，供货期短、价格较优。  
例：0805与1206规格同样能满足要求的，请选用0805规格；  
0603与0805规格同样能满足要求的，请选用0603规格。
- 厚度特殊要求，请咨询火炬电子4008-878799。



引线式多层瓷介电容器

# 引线式多层瓷介电容器

CC4型、CT4型引线式多层瓷介电容器



## 执行标准

- 总规范: GB/T 2693-2001《电子设备用固定电容器第1部分:总规范》  
 分规范: GB/T5966-2011《电子设备用固定电容器第8部分:分规范1类瓷介固定电容器》  
 GB/T5968-2011《电子设备用固定电容器第9部分:分规范2类瓷介固定电容器》  
 详细规范: GB/T5967-2011《电子设备用固定电容器第8-1部分:1类瓷介固定电容器评定水平EZ》  
 GB/T5969-2012《电子设备用固定电容器第9-1部分:2类瓷介固定电容器评定水平EZ》



## 产品应用

- CG: 属1类陶瓷介质, 电气性能最稳定, 基本上不随温度、时间、电压的改变而改变, 适用于稳定性、可靠性要求较严格的场合。由于电气性能稳定, 高频特性好, 可很好地工作在高频、特高频、甚高频频段。  
 2X1、X5R: 属2类陶瓷介质, 电气性能稳定, 随温度、时间、电压的变化, 其特性变化并不明显, 适用于要求较高的耦合、旁路、滤波电路及10MHz以下的中频场合。  
 2F4: 属2类陶瓷介质, 具有很高的介电系数, 常用于生产小体积、大电容的电容器, 其容量随温度改变比较明显, 抗恶劣环境能力较差, 但成本低, 仍广泛应用于要求不高的滤波、旁路等电路场合。

## 选用示例

CC4 CT4	0805 1206	CG 2X1	50V 100V	100pF 0.1 μF	J K			
型号	外形尺寸	温度特性	额定电压	标称容量	允许偏差	腿形	腿长	包装方式
①	②	③	④	⑤	⑥	⑦	⑧	⑨

如无特殊要求不填写

### ① 型号

- CC4: 引线式1类多层瓷介(独石)电容器(CG)  
 CT4: 引线式2类多层瓷介(独石)电容器(2X1、X5R、2F4)

### ② 外形尺寸(以所选用的电容器芯片尺寸代码作为该电容器的外形代码)

单位: mm

外形代码	0805	0805	1206	1210	1812	2225
Wmax	4.85	4.85	5.86	5.86	7.14	8.62
Hmax	4.16	4.16	4.36	4.80	6.00	8.62
Tmax	3.70	3.70	4.10	4.20	4.20	4.20
F	2.54 ± 0.1	5.08 ± 0.1	5.08 ± 0.1	5.08 ± 0.1	5.08 ± 0.12	5.08 ± 0.12
d	0.5 ± 0.05	0.5 ± 0.05	0.5 ± 0.05	0.5 ± 0.05	0.6 ± 0.05	0.6 ± 0.05
腿长Lmin	25.4	25.4	25.4	25.4	25.4	25.4
外形图						
腿形代号	L 直腿	H 标准腿	H 标准腿	H 标准腿	H 标准腿	H 标准腿

说明: ①如需特别小颗粒的产品请附图联系特制。

②一旦提出要求, 可以提供本表以外的任何腿形、腿距。

### ③ 温度特性

组别	CG	2X1	X5R	2F4
温度特性	(0 ± 30)ppm/°C	± 15%	± 15%	+30% ~ -80%
温度范围	-55°C ~ 125°C	-55°C ~ 125°C	-55°C ~ 85°C	-30°C ~ 85°C

### ④ 额定电压: 直标法

6.3V 10V 16V 25V 50V(63V) 100V 200V  
 250V 500V 630V 1kV 2kV 3kV

### ⑤ 标称容量

■ 采用直标法表示标称容量

例: 0.5pF 100pF 1000pF 0.01 μF 0.1 μF

■ 采用三位数表示法, 前二位数有效数, 第三位为“0”的个数, 单位: pF

例: 0R5 = 0.5pF 5R0 = 5pF 7R5 = 7.5pF (P或R代表小数点)  
 100 = 10pF 101 = 100pF 104 = 100000pF = 0.1 μF

# 引线式多层瓷介电容器

CC4型、CT4型引线式多层瓷介电容器



## ⑥ 允许偏差

组 别	CG						2X1/X5R			2F4	
	B(特选)*	C*	D*	F(特选)	G(特选)	J	J(特选)	K	M	S	Z
允许偏差	±0.1pF	±0.25pF	±0.5pF	±1%	±2%	±5%	±5%	±10%	±20%	+50~-20%	+80~-20%

\*C<sub>R</sub>≤10pF; 特殊精度产品请咨询火炬电子应用工程部

## ⑦ 腿形: L=直腿 H=标准腿

注: 如无特别说明出厂前以标准腿H制作。

## ⑧ 腿长: 优选腿长: 3=3.0±1mm 6=6.0±1mm 9=9.0±1mm

注: 如无特别说明出厂前腿长以L≥25.4mm制作, 特殊腿长要求, 以数字直标。

## ⑨ 包装方式

T=塑胶袋散装 500只/包 4000只/盒(8包)  
 0805尺寸: 5000只/盒(10包), 2225尺寸: 400只/包  
 A=卷装编带包装 2500只/盘(有J、A二种高度, 详见图1、图2)  
 B=盒装折叠编带包装 2000只/盒(有B、Z二种高度, 详见图1、图3)  
 注: 无特别说明, 出产前以500只/塑胶袋包装。

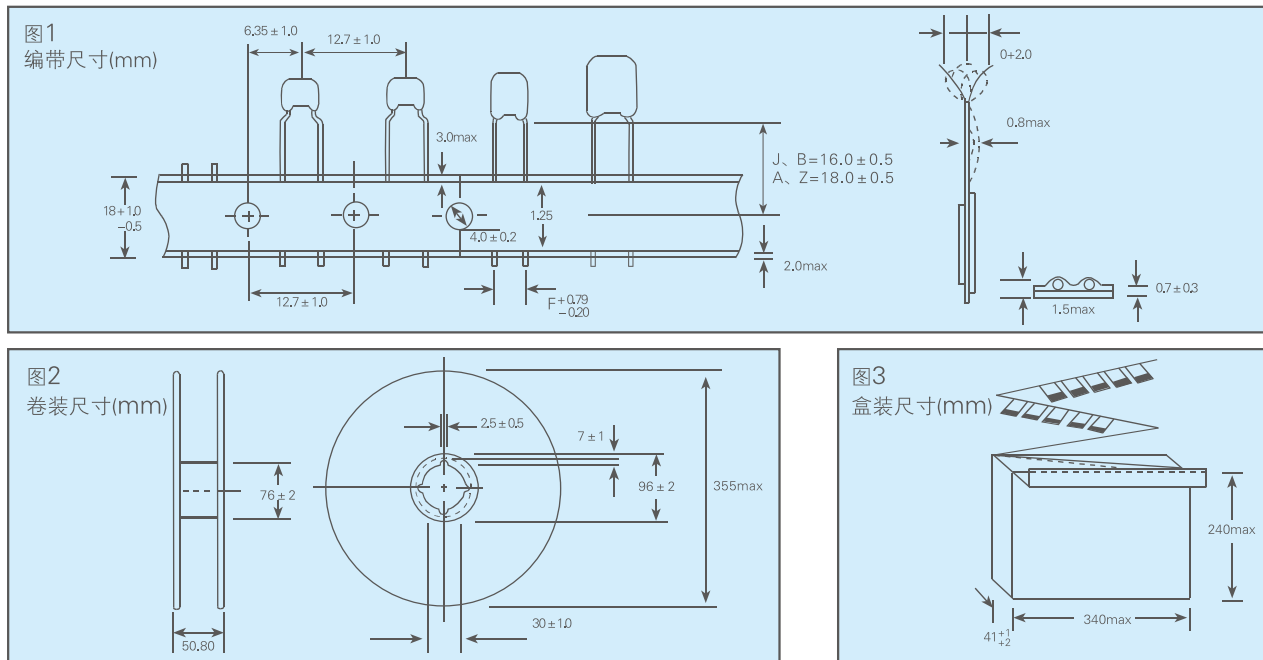

## 电气参数

特性	损耗角正切(C <sub>R</sub> 单位: pF)	介质耐电压	25°C绝缘电阻(C <sub>R</sub> 单位: μF)	类别温度范围
CG	C <sub>R</sub> ≤30pF $\text{tg } \delta \leq \frac{1}{(400+20C_R)}$ C <sub>R</sub> >30pF $\text{tg } \delta \leq 10 \times 10^{-4}$	U <sub>R</sub> ≤200V 2.5U <sub>R</sub> U <sub>R</sub> =250V 2.0U <sub>R</sub> U <sub>R</sub> =500V 1.5U <sub>R</sub> U <sub>R</sub> ≥630V 1.2U <sub>R</sub>	C <sub>R</sub> ≤0.01μF IR≥10 <sup>4</sup> MΩ C <sub>R</sub> >0.01μF IR≥ $\frac{100}{C_R}$ MΩ	-55°C~125°C
2X1	6.3V≤U <sub>R</sub> <16V $\text{tg } \delta \leq 1000 \times 10^{-4}$ 16V≤U <sub>R</sub> <25V $\text{tg } \delta \leq 700 \times 10^{-4}$ 25V≤U <sub>R</sub> <50V $\text{tg } \delta \leq 500 \times 10^{-4}$ U <sub>R</sub> ≥50V $\text{tg } \delta \leq 350 \times 10^{-4}$		C <sub>R</sub> ≤0.025μF IR≥4GΩ C <sub>R</sub> >0.025μF IR≥ $\frac{100}{C_R}$ MΩ	
X5R	10V≤U <sub>R</sub> <16V $\text{tg } \delta \leq 1000 \times 10^{-4}$ 16V≤U <sub>R</sub> <25V $\text{tg } \delta \leq 700 \times 10^{-4}$ 25V≤U <sub>R</sub> <50V $\text{tg } \delta \leq 500 \times 10^{-4}$ U <sub>R</sub> ≥50V $\text{tg } \delta \leq 500 \times 10^{-4}$		-30°C~85°C	

注: 0603或0603以下尺寸的2X1、X5R、2F4产品, 或者容量大于等于1μF的2X1、X5R、2F4产品, 损耗角正切值 $\text{tg } \delta \leq 1000 \times 10^{-4}$

# 引线式多层瓷介电容器

CC4型、CT4型引线式多层瓷介电容器



## 容量范围

CC4型

外形尺寸	0805							1206							1210							1812							2225																						
引线形式	L.H							H							H							H							H																						
额定电压(V)	50	100	200	250	500	630	1k	50	100	200	250	500	630	1k	2k	3k	50	100	200	250	500	630	1k	2k	3k	50	100	200	250	500	630	1k	2k	3k	25	50	100	200	250	500	630	1k	2k	3k							
cap (pF)	0.5	1.0						0.5	1.0	1.5						0.5	1.0	1.5	2.2						0.5	1.0	1.5	2.2	3.3					0.5	1.0	1.5	2.2	3.3	4.7				0.5	1.0	1.5	2.2	3.3	4.7	6.8		
	8.2							8.2	10	12					8.2	10	12	15					8.2	10	12	15	18					8.2	10	12	15	18	22														
	27							27	33	39					27	33	39	47					27	33	39	47	56					27	33	39	47	56	68														
	100							100	120	150					100	120	150	180					100	120	150	180	220					100	120	150	180	220	270														
	330							330	390	470					330	390	470	560					330	390	470	560	680					330	390	470	560	680	820														
cap (μF)	.010							.010	.012	.015					.010	.012	.015	.018					.010	.012	.015	.018	.022					.010	.012	.015	.018	.022	.027														
	.033							.033	.039	.047					.033	.039	.047	.056					.033	.039	.047	.056	.068					.033	.039	.047	.056	.068	.082														
	.10							.10	.12	.15					.10	.12	.15	.18					.10	.12	.15	.18	.22					.10	.12	.15	.18	.22	.27														
	.33							.33	.39	.47					.33	.39	.47	.56					.33	.39	.47	.56	.68					.33	.39	.47	.56	.68	.82														

CG

# 引线式多层瓷介电容器

CC4型、CT4型引线式多层瓷介电容器



## 容量范围

### CT4型

外形尺寸	0805													1206											1210													
	L.H													H											H													
引腿形式	4	6.3	10	16	25	50	100	200	250	500	630	1k	4	6.3	10	16	25	50	100	200	250	500	630	1k	2k	4	6.3	10	16	25	50	100	200	250	500	630	1k	2k
额定电压(V)																																						
cap (pF) 100																																						
120																																						
150																																						
180																																						
220																																						
270																																						
330																																						
390																																						
470																																						
560																																						
680																																						
820																																						
1000																																						
1200																																						
1500																																						
1800																																						
2200																																						
2700																																						
3300																																						
3900																																						
4700																																						
5600																																						
6800																																						
8200																																						
cap ( $\mu F$ ) .010																																						
.012																																						
.015																																						
.018																																						
.022																																						
.027																																						
.033																																						
.039																																						
.047																																						
.056																																						
.068																																						
.082																																						
.10																																						
.12																																						
.15																																						
.18																																						
.22																																						
.27																																						
.33																																						
.39																																						
.47																																						
.56																																						
.68																																						
.82																																						
1.0																																						
1.5																																						
2.2																																						
3.3																																						
4.7																																						
6.8																																						
10.0																																						
22.0																																						
33.0																																						
47.0																																						
100.0																																						
150.0																																						
220.0																																						
330.0																																						

2X1  
 X5R

\*DF(损耗角正切)最大值按12.5%控制

- 要了解最大容量及更详细技术参数，请联络火炬电子。
- 外形尺寸的优选建议：相同的容量、耐压、精度，选用较小尺寸的规格，供货期短、价格较优。  
例：0805与1206规格同样能满足要求的，请选用0805规格。
- 厚度特殊要求，请咨询火炬电子4008-878799。





加严型引线式多层瓷介电容器



# 加严型引线式多层瓷介电容器

CT4G型引线式多层瓷介电容器

## 执行标准

总规范: GB/T 2693-2001《电子设备用固定电容器第1部分:总规范》  
 分规范: GB/T5966-2011《电子设备用固定电容器第8部分:分规范1类瓷介固定电容器》  
 GB/T5968-2011《电子设备用固定电容器第9部分:分规范2类瓷介固定电容器》  
 详细规范: GB/T5967-2011《电子设备用固定电容器第8-1部分:1类瓷介固定电容器评定水平EZ》  
 GB/T5969-2012《电子设备用固定电容器第9-1部分:2类瓷介固定电容器评定水平EZ》  
 加严产品规格书:Q/HJ 5999-2006



## 产品应用

2X1、X5R: 属2类陶瓷介质, 电气性能稳定, 随温度、时间、电压的变化, 其特性变化并不明显, 适用于要求较高的耦合、旁路、滤波电路及10MHz以下的中频场合。

## 选用示例

CT4G	1206	2X1	100V	0.1 μF	K	H	L	T
型号	外形尺寸	温度特性	额定电压	标称容量	允许偏差	腿形	腿长	包装方式
①	②	③	④	⑤	⑥	⑦	⑧	⑨
如无特殊要求不填写								

### ① 型号

CT4G: 加严型引线式多层瓷介(独石)电容器(2X1、X5R)

### ② 外形尺寸(以所选用的电容器芯片尺寸代码作为该电容器的外形代码)

单位: mm

外形代码	0805	0805	1206	1210	1812	2225
Wmax	4.85	4.85	5.86	5.86	7.14	8.62
Hmax	4.16	4.16	4.36	4.80	6.00	8.62
Tmax	3.70	3.70	4.10	4.20	4.20	4.20
F	2.54±0.1	5.08±0.1	5.08±0.1	5.08±0.1	5.08±0.12	5.08±0.12
d	0.5±0.05	0.5±0.05	0.5±0.05	0.5±0.05	0.6±0.05	0.6±0.05
腿长Lmin	25.4	25.4	25.4	25.4	25.4	25.4
外形图						
腿形代号	L 直腿		H 标准腿		H 标准腿	

说明: ①如需特别小颗粒的产品请附图联系特制。

②一旦提出要求, 可以提供本表以外的任何腿形、腿距。

### ③ 温度特性

组别	2X1	X5R
温度特性	±15%	±15%
温度范围	-55℃~125℃	-55℃~85℃

### ④ 额定电压: 直标法

6.3V 10V 16V 25V 50V(63V)  
 100V 200V 250V 500V 630V  
 1kV 2kV 3kV

# 加严型引线式多层瓷介电容器

CT4G型引线式多层瓷介电容器



## ⑤ 标称容量

■ 采用直标法表示标称容量

例: 0.5pF 100pF 1000pF 0.01 $\mu$ F 0.1 $\mu$ F

■ 采用三位数表示法, 前二位数有效数, 第三位为“0”的个数, 单位: pF

例: 0R5 = 0.5pF 5R0 = 5pF 7R5 = 7.5pF (P或R代表小数点)

100 = 10pF 101 = 100pF 104 = 100000pF = 0.1 $\mu$ F

## ⑥ 允许偏差

组 别	2X1/X5R		
代 码	J(特选)	K	M
允许偏差	$\pm 5\%$	$\pm 10\%$	$\pm 20\%$

注: 特殊精度产品请咨询火炬电子应用工程部

⑦ 腿形: L=直腿 H=标准腿

注: 如无特别说明出厂前以标准腿H制作。

⑧ 腿长: 优选腿长: 3=3.0 $\pm$ 1mm 6=6.0 $\pm$ 1mm 9=9.0 $\pm$ 1mm

注: 如无特别说明出厂前腿长以L $\geq$ 25.4mm制作, 特殊腿长要求, 以数字直标。

## ⑨ 包装方式

T=塑胶袋散装

500只/包 4000只/盒(8包)

0805尺寸: 5000只/盒(10包), 2225尺寸: 400只/包

A=卷装编带包装

2500只/盘(有J、A二种高度, 详见图1、图2)

B=盒装折叠编带包装

2000只/盒(有B、Z二种高度, 详见图1、图3)

注: 无特别说明, 出厂前以500只/塑胶袋包装。

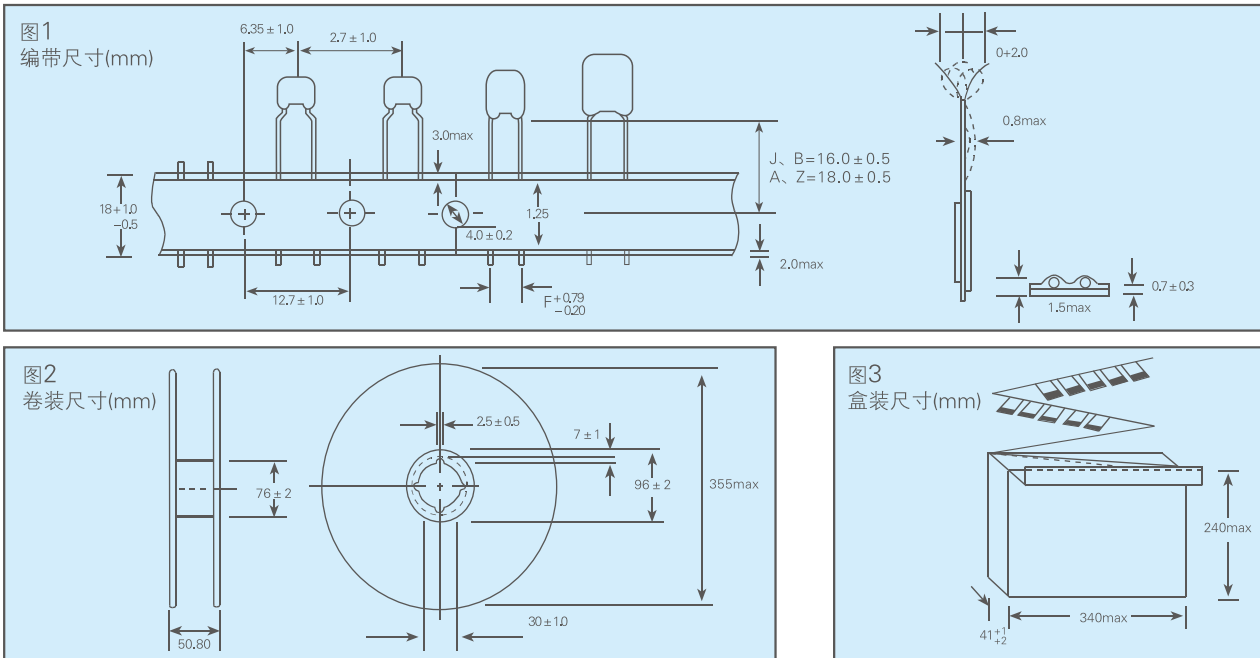

## 电气参数

C<sub>R</sub>单位:  $\mu$ F

特性	损耗角正切	介质耐电压	25 $^{\circ}$ C绝缘电阻	类别温度范围
2X1	6.3V $\leq$ U <sub>R</sub> <16V 16V $\leq$ U <sub>R</sub> <25V 25V $\leq$ U <sub>R</sub> <50V	U <sub>R</sub> $\leq$ 200V 3.0U <sub>R</sub> U <sub>R</sub> =250V 2.0U <sub>R</sub> U <sub>R</sub> =500V 1.5U <sub>R</sub> U <sub>R</sub> $\geq$ 630V 1.2U <sub>R</sub>	C <sub>R</sub> $\leq$ 0.025 $\mu$ F IR $\geq$ 20G $\Omega$ C <sub>R</sub> >0.025 $\mu$ F IR $\geq$ $\frac{500}{C_R}$ M $\Omega$	-55 $^{\circ}$ C~125 $^{\circ}$ C
X5R	U <sub>R</sub> $\geq$ 50V			-55 $^{\circ}$ C~85 $^{\circ}$ C

注: 0603或0603以下尺寸的2X1、X5R产品, 或者容量大于等于1 $\mu$ F的2X1、X5R产品, 损耗角正切值tg $\delta$  $\leq$ 1000 $\times$ 10 $^{-4}$ 部分极限2X1、X5R产品, 绝缘电阻指标请以产品规格书为准或咨询火炬电子应用工程部



# 加严型引线式多层瓷介电容器

CT4G型引线式多层瓷介电容器

## 容量范围

CT4G型

外形尺寸	1812												2225											
引线形式	H												H											
额定电压(V)	6.3	10	16	25	50	100	200	250	500	630	1k	2k	3k	50	100	200	250	500	630	1k	2k	3k		
cap (pF)																								
100																								
120																								
150																								
180																								
220																								
270																								
330																								
390																								
470																								
560																								
680																								
820																								
1000																								
1200																								
1500																								
1800																								
2200																								
2700																								
3300																								
3900																								
4700																								
5600																								
6800																								
8200																								
cap (μF)																								
.010																								
.012																								
.015																								
.018																								
.022																								
.027																								
.033																								
.039																								
.047																								
.056																								
.068																								
.082																								
.10																								
.12																								
.15																								
.18																								
.22																								
.27																								
.33																								
.39																								
.47																								
.56																								
.68																								
.82																								
1.0																								
1.5																								
2.2																								
3.3																								
4.7																								
6.8																								
10.0																								
22.0																								
33.0																								
47.0																								
100.0																								
150.0																								
220.0																								
330.0																								

2X1  
X5R

- 要了解最大容量及更详细技术参数, 请联络火炬电子。
- 外形尺寸的优选建议: 相同的容量、耐压、精度, 选用较小尺寸的规格, 供货期短、价格较优。  
例: 0805与1206规格同样能满足要求的, 请选用0805规格。
- 厚度特殊要求, 请咨询火炬电子4008-878799。



片式高压多层瓷介电容器

# 片式高压多层瓷介电容器

CC48型、CT48型高压片式多层瓷介电容器



## 执行标准

总规范：GB/T 2693-2001《电子设备用固定电容器第1部分：总规范》  
分规范：GB/T 21041-2007《电子设备用固定电容器第21部分：分规范》  
GB/T 21042-2007《电子设备用固定电容器第22部分：分规范》



## 选用示例

CC48 CT48	1808 1206	CG 2X1	1kV 1kV	100pF 1000pF	J K	N N	T T
型号	外形尺寸	温度特性	额定电压	标称容量	允许偏差	端头形式	包装方式
①	②	③	④	⑤	⑥	⑦	⑧

### ① 型号

CC48：1类高压片式多层瓷介电容器(CG)  
CT48：2类高压片式多层瓷介电容器(2X1)

### ② 外形尺寸

单位：mm

外形轮廓图	0603	0805	1206	1210	1808	1812	2220	2225
	L	1.60±0.20	2.00±0.30	3.20±0.30	3.20±0.40	4.50±0.40	4.50±0.40	5.70±0.50
	W	0.80±0.20	1.25±0.20	1.60±0.30	2.50±0.30	2.00±0.30	3.20±0.30	5.00±0.50
	T <sub>max</sub>	1.00	1.45	1.90	2.80	2.30	3.50	4.20
	t	0.35±0.25	0.50±0.25	0.50±0.35	0.60±0.30	0.64±0.38	0.90±0.60	0.90±0.60

注：厚度有特别要求的，请咨询火炬电子4008-878799

### ③ 温度特性

组别	CG	2X1
温度特性	0±30ppm/°C	±15%
温度范围	-55°C~125°C	-55°C~125°C

### ④ 额定电压：直标法

250V 500V 630V 1kV 2kV 3kV

### ⑤ 标称容量

■ 采用直标法表示标称容量

例：0.5pF 100pF 1000pF 0.01μF 0.1μF

■ 采用三位数表示法，前二位数有效数，第三位为“0”的个数，单位：pF

例：0R5=0.5pF 5R0=5pF 7R5=7.5pF (P或R代表小数点)

100=10pF 101=100pF 104=100000pF=0.1μF

### ⑥ 允许偏差

组别	CG						2X1		
	B(特选)*	C*	D*	F(特选)	G(特选)	J	J(特选)	K	M
允许偏差	±0.1pF	±0.25pF	±0.5pF	±1%	±2%	±5%	±5%	±10%	±20%

\*C<sub>n</sub>≤10pF；特殊精度产品请咨询火炬电子应用工程部

### ⑦ 端头材料

N=基体金属化-金属阻挡层-锡(无铅化)

G=基体金属化-金属阻挡层-金

### ⑧ 包装方式

T=散装 1000只/包 500只/包

F=纸编带盘装 4000只/盘 0603、0805、1206尺寸

E=塑编带盘装 500只/盘 1210、1808、2220、2225尺寸

1000只/盘 1210、1812尺寸

2000只/盘 0805、1206、1210、1808、1812尺寸

3000只/盘 0805、1206尺寸

## 电气参数

C<sub>n</sub>单位：μF

特性	损耗角正切	介质耐电压	25°C绝缘电阻	类别温度范围
CG	tg δ ≤ 10 × 10 <sup>-4</sup>	U <sub>R</sub> =250V 2.0U <sub>R</sub> U <sub>R</sub> =500V 1.5U <sub>R</sub>	C <sub>R</sub> ≤ 0.05μF IR ≥ 10GΩ	-55°C~125°C
2X1	tg δ ≤ 250 × 10 <sup>-4</sup>	U <sub>R</sub> ≥ 630V 1.2U <sub>R</sub>	C <sub>R</sub> > 0.05μF IR ≥ $\frac{500}{C_R}$ MΩ	-55°C~125°C

注：0603或0603以下尺寸的2X1产品，或者容量大于等于1μF的2X1产品，损耗角正切值tg δ ≤ 1000×10<sup>-4</sup>部分极限2X1产品，绝缘电阻指标请以产品规格书为准或咨询火炬电子应用工程部

# 片式高压多层瓷介电容器

CC48型、CT48型高压片式多层瓷介电容器



## 容量范围

CC48型

外形尺寸	0603			0805			1206					1210					1808					1812					2220					2225				
额定电压(V)	250	500	250	500	630	1k	250	500	630	1k	2k	3k	250	500	630	1k	2k	3k	500	630	1k	2k	3k	250	500	630	1k	2k	3k	250	500	630	1k	2k	3k	
cap (pF)																																				
10																																				
12																																				
15																																				
18																																				
22																																				
27																																				
33																																				
39																																				
47																																				
56																																				
68																																				
82																																				
100																																				
120																																				
150																																				
180																																				
220																																				
270																																				
330																																				
390																																				
470																																				
560																																				
680																																				
820																																				
1000																																				
1200																																				
1500																																				
1800																																				
2200																																				
2700																																				
3300																																				
3900																																				
4700																																				
5600																																				
6800																																				
8200																																				
cap (μF)																																				
.010																																				
.012																																				
.015																																				
.018																																				
.022																																				
.027																																				
.033																																				
.039																																				
.047																																				
.056																																				
.068																																				
.082																																				
.10																																				

CG

- 要了解最大容量详细技术参数，请联络火炬电子。
- 外形尺寸的优选建议：相同的容量、耐压、精度，选用较小尺寸的规格，供货期短、价格较优。  
例：0805与1206规格同样能满足要求的，请选用0805规格。
- 厚度特殊要求，请咨询火炬电子4008-878799。

# 片式高压多层瓷介电容器

CC48型、CT48型高压片式多层瓷介电容器

## 容量范围

CT48型

外形尺寸	0603			0805			1206					1210					1808					1812					2220					2225									
额定电压(V)	250	500		250	500	630	1k	250	500	630	1k	2k	250	500	630	1k	2k	250	500	630	1k	2k	3k	250	500	630	1k	2k	3k	250	500	630	1k	2k	3k	250	500	630	1k	2k	3k
cap (pF)																																									
100																																									
120																																									
150																																									
180																																									
220																																									
270																																									
330																																									
390																																									
470																																									
560																																									
680																																									
820																																									
1000																																									
1200																																									
1500																																									
1800																																									
2200																																									
2700																																									
3300																																									
3900																																									
4700																																									
5600																																									
6800																																									
8200																																									
cap (μF)																																									
.010																																									
.012																																									
.015																																									
.018																																									
.022																																									
.027																																									
.033																																									
.039																																									
.047																																									
.056																																									
.068																																									
.082																																									
.10																																									
.12																																									
.15																																									
.18																																									
.22																																									
.27																																									
.33																																									
.39																																									
.47																																									
.56																																									
.68																																									
.82																																									
1.0																																									
1.5																																									

2X1

- 要了解最大容量详细技术参数，请联络火炬电子。
- 外形尺寸的优选建议：相同的容量、耐压、精度，选用较小尺寸的规格，供货期短、价格较优。  
例：0805与1206规格同样能满足要求的，请选用0805规格。
- 厚度特殊要求，请咨询火炬电子4008-878799。





模 压 表 贴 瓷 介 电 容 器

# 模压表贴瓷介电容器

CT45型模压表贴瓷介电容器

## 执行标准

详细规范: Q/HJ011-2011《CT45型模压表贴瓷介固定电容器详细规范》

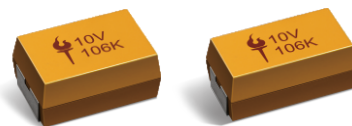

## 产品特点

- ① 环氧模压, 密封性好, 物理强度高, 防潮性能好;
- ② 表贴式, 体积小, 重量轻;
- ③ 无极性, 便于安装;
- ④ 耗散功率极小 (约钽电容器的1/4);
- ⑤ 相对于钽电容器高频特性好 (1MHz以下频段均呈容性);
- ⑥ 精密模压, 激光标志。

## 产品应用

适用于高频开关电源、电源总线滤波、输出/输入滤波。

## 选用示例

CT45	B	X7R	50V	105	M	T
型号	外形尺寸	温度特性	额定电压	标称容量	允许偏差	包装方式
模压表贴 瓷介电容器	A壳 B壳	X7R: ±15% (-55°C ~ 125°C) X5R: ±15% (-55°C ~ 85°C)	6V 10V 16V 25V 35V 50V	见容量 范围表	K= ±10% M= ±20%	T=防静电袋 散包装 E=盘卷包装

## 外形尺寸

单位: mm(inch)

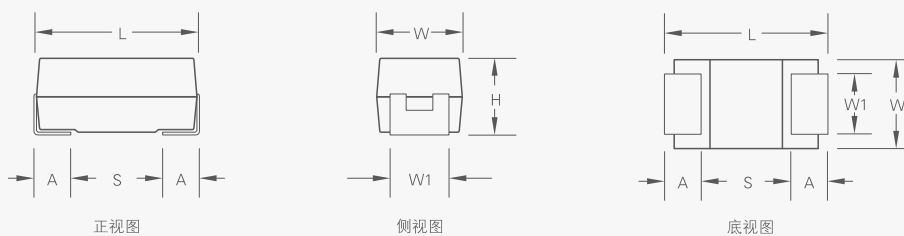

外形代码	EIA Code	$L \pm 0.20$ (0.008)	$W \pm 0.20(0.008)$ $-0.10(0.004)$	$H \pm 0.20(0.008)$ $-0.10(0.004)$	$W1 \pm 0.20$ (0.008)	$A \pm 0.30(0.012)$ $-0.20(0.008)$	S min
A	3216-18	3.20(0.126)	1.60(0.063)	1.60(0.063)	1.20(0.047)	0.80(0.031)	1.10(0.043)
B	3528-21	3.50(0.138)	2.80(0.110)	1.90(0.075)	2.20(0.087)	0.80(0.031)	1.40(0.055)

# 模压表贴瓷介电容器

CT45型模压表贴瓷介电容器



## 电气参数

C<sub>R</sub>单位: μF

特性	损耗角正切	介质耐电压	25℃绝缘电阻	类别温度范围
X7R	$U_R < 25V \quad \text{tg } \delta \leq 1000 \times 10^{-4}$ $U_R \geq 25V \quad \text{tg } \delta \leq 500 \times 10^{-4}$	2.5U <sub>R</sub>	$C_R \leq 0.025\mu\text{F} \quad IR \geq 4G\Omega$ $C_R > 0.025\mu\text{F} \quad IR \geq \frac{100}{C_R} \text{M}\Omega$	-55℃~125℃
X5R				-55℃~85℃

## 容量范围

外形尺寸	A						B					
	6	10	16	25	35	50	6	10	16	25	35	50
cap 104												
(pF) 154												
224												
334												
474												
684												
105												
155												
225												
335												
475												
685												
106												
156												

- X7R
- X5R

## 标识

电容器本体顶部用激光标识, 如下图

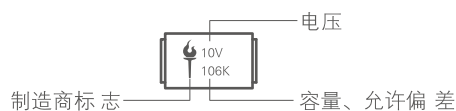



片 式 固 体 钽 电 容 器

# 片式固体钽电容器

TAJ型、TPS型、TAC型片式固体钽电容器

## 执行标准

总规范：EIA-535BAAC

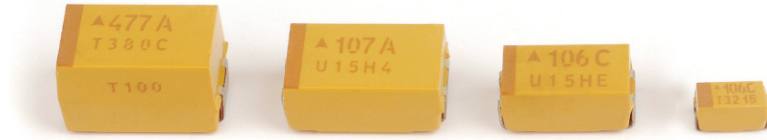

## 选用示例

### (1) 国标片式钽电容

CA45	C	16V	106	M	R
国标型号 CA45标准型	外形尺寸 (见外形尺寸表)	额定电压 2V 2.5V 3V 4V 6.3V 10V 16V 20V 25V 35V 50V	标称容量 直标法 三位数表示法 前二位有效数 第三位“0”的个数 (见容量范围表)	允许偏差 K=±10% M=±20%	包装代码 R=7"盘 塑带包装 S=13"盘 塑带包装 (见标准包装表)

### (2) AVX片式钽电容

TAJ	D	106	M	016	R	0100
AVX型号 TAJ标准型 TPS低ESR型 TAC超薄型	外形尺寸 (见外形尺寸表)	标称容量 直标法 三位数表示法 前二位有效数 第三位“0”的个数 (见容量范围表)	允许偏差 K=±10% M=±20%	额定电压 002=2.5V(2V) 003=3V 004=4V 006=6.3V 010=10V 016=16V 020=20V 025=25V 035=35V 050=50V	包装代码 R=7"盘 塑带包装 S=13"盘 塑带包装 (见标准包装表)	ESR值 TPS型适用 例： 0100=100mΩ 1000=1Ω (NJ=标准品)

## 外形尺寸

片式固体钽电容器

单位：mm(inch)

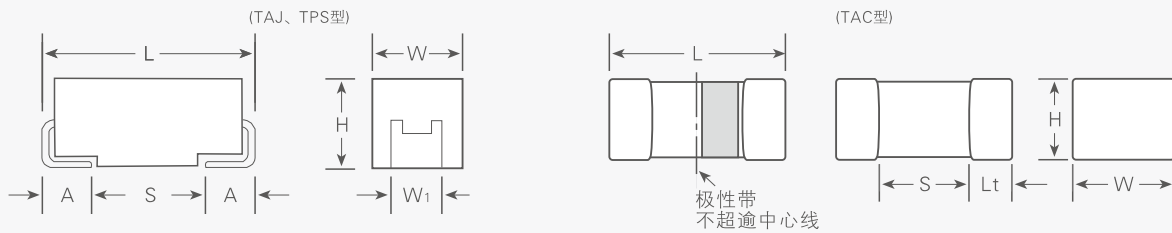

型号	外形代码	EIA Code	$L \pm 0.20$ (0.008)	$W \pm 0.20$ (0.008) $-0.10$ (0.004)	$H \pm 0.20$ (0.008) $-0.10$ (0.004)	$W1 \pm 0.20$ (0.008)	$A \pm 0.30$ (0.012) $-0.20$ (0.008)	S min
TAJ 标准型	A	3216-16	3.20(0.126)	1.60(0.063)	1.60(0.063)	1.20(0.047)	0.80(0.031)	1.10(0.043)
	B	3528-21	3.50(0.138)	2.80(0.110)	1.90(0.075)	2.20(0.087)	0.80(0.031)	1.40(0.055)
	C	6032-28	6.00(0.236)	3.20(0.126)	2.60(0.102)	2.20(0.087)	1.30(0.051)	2.90(0.114)
	D	7343-31	7.30(0.287)	4.30(0.169)	2.90(0.114)	2.40(0.094)	1.30(0.051)	4.40(0.173)
	E	7343-43	7.30(0.287)	4.30(0.169)	4.10(0.162)	2.40(0.094)	1.30(0.051)	4.40(0.173)
	V	7361-38	7.30(0.287)	6.10(0.240)	3.55(0.140)	3.10(0.120)	1.30(0.051)	4.40(0.173)
	U	7361-43	7.30(0.287)	6.10(0.240)	4.10(0.162)	3.10(0.120)	1.30(0.051)	4.40(0.173)

# 片式固体钽电容器

TAJ型、TPS型、TAC型片式固体钽电容器



型号	外形代码	EIA Code	$L \pm 0.20$ (0.008)	$W \pm 0.20(0.008)$ $-0.10(0.004)$	$H \pm 0.20(0.008)$ $-0.10(0.004)$	$W1 \pm 0.20$ (0.008)	$A \pm 0.30(0.012)$ $-0.20(0.008)$	S min
TPS 低ESR型	A	3216-18	3.20(0.126)	1.60(0.063)	1.60(0.063)	1.20(0.047)	0.80(0.031)	1.10(0.043)
	B	3528-21	3.50(0.138)	2.80(0.110)	1.90(0.075)	2.20(0.087)	0.80(0.031)	1.40(0.055)
	C	6032-28	6.00(0.236)	3.20(0.126)	2.60(0.102)	2.20(0.087)	1.30(0.051)	2.90(0.114)
	D	7343-31	7.30(0.287)	4.30(0.169)	2.90(0.114)	2.40(0.094)	1.30(0.051)	4.40(0.173)
	E	7343-43	7.30(0.287)	4.30(0.169)	4.10(0.162)	2.40(0.094)	1.30(0.051)	4.40(0.173)
	F	6032-20	6.00(0.236)	3.20(0.126)	2.00(0.079)max.	2.20(0.087)	1.30(0.051)	2.90(0.114)
	P	2012-15	2.05(0.081)	1.35(0.053)	1.50(0.059)max.	$1.00 \pm 0.10$ $(0.039 \pm 0.004)$	0.50(0.020)	0.85(0.033)
	R	2012-12	2.05(0.081)	1.30(0.051)	1.20(0.047)max.	$1.00 \pm 0.10$ $(0.039 \pm 0.004)$	0.50(0.020)	0.85(0.033)
	S	3216-12	3.20(0.126)	1.60(0.063)	1.20(0.047)max.	1.20(0.047)	0.80(0.031)	1.10(0.043)
	T	3528-12	3.50(0.138)	2.80(0.110)	1.20(0.047)max.	2.20(0.087)	0.80(0.031)	1.40(0.055)
	V	7361-38	7.30(0.287)	6.10(0.240)	3.55(0.140)	3.10(0.120)	1.30(0.051)	4.40(0.173)
	W	6032-15	6.00(0.236)	3.20(0.126)	1.50(0.059)max.	2.20(0.087)	1.30(0.051)	2.90(0.114)
	X	7343-15	7.30(0.287)	4.30(0.169)	1.50(0.059)max.	2.40(0.094)	1.30(0.051)	4.40(0.173)
	Y	7343-20	7.30(0.287)	4.30(0.169)	2.00(0.079)max.	2.40(0.094)	1.30(0.051)	4.40(0.173)
型号	外形代码	EIA Code	L	W	H	W1	Lt min	S min
TAC 超薄型	A	3216-18	$3.20 \pm 0.20$ $(0.126 \pm 0.008)$	$1.60 \pm 0.20$ $(0.063 \pm 0.008)$	$1.60 \pm 0.20$ $(0.063 \pm 0.008)$	—	0.15(0.006)	1.80(0.071)
	B	3528-15	$3.50^{+0.20}_{-0.20}$ $(0.138^{+0.008}_{-0.008})$	$2.80^{+0.20}_{-0.10}$ $(0.110^{+0.008}_{-0.004})$	1.50(0.059)max.	—	0.15(0.006)	2.00(0.079)
	K	1005-17	1.00 (0.039)	$0.50^{+0.20}_{-0.00}$ $(0.020^{+0.008}_{-0.000})$	$0.50^{+0.20}_{-0.00}$ $(0.020^{+0.008}_{-0.000})$	—	0.10(0.004)	0.40(0.016)
	L	1608-10	1.60 (0.063)	0.85 (0.033)	0.85 (0.033)	—	0.15(0.006)	0.55(0.022)
	R	2012-15	2.00 (0.079)	1.35 (0.053)	1.35 (0.053)	—	0.15(0.006)	0.70(0.027)
	H	2012-10	2.00 (0.079)	1.35 (0.053)	1.00max. (0.039max.)	—	0.15(0.006)	0.70(0.027)
	J	1608-08	1.60 (0.063)	0.85 (0.033)	0.75max. (0.030max.)	—	0.15(0.006)	0.55(0.022)
	T	3528-12	$3.50^{+0.20}_{-0.20}$ $(0.138^{+0.008}_{-0.008})$	$2.80^{+0.20}_{-0.10}$ $(0.110^{+0.008}_{-0.004})$	1.20max. (0.047max.)	—	0.15(0.006)	2.00(0.079)
	U	2012-06	2.00 (0.079)	1.35 (0.053)	0.60max. (0.024max.)	—	0.15(0.006)	0.70(0.027)
	V	3216-08	$3.20 \pm 0.20$ $(0.126 \pm 0.008)$	$1.60 \pm 0.20$ $(0.063 \pm 0.008)$	0.75max. (0.030max.)	—	0.15(0.006)	1.80(0.071)

注：在相同的尺寸允许提供比其所订额定电压更高的规格替代。

## 电气参数

项目	试验条件	电性能指标
电容量(C) 损耗角正切(tg δ)	测试频率：120Hz 测试电压：0.5Vrms	电容量在规定范围内
		按AVX片式钽电容器规格书规定
漏电流(DCL)	测试电压： $U_R$ 测试时间：5min	按AVX片式钽电容器规格书规定

# 片式固体钽电容器

TAJ型、TPS型、TAC型片式固体钽电容器



## 容量范围

TAJ标准型

容量 ( $\mu$ F)	代码	2.5V(E)	4V(G)	6.3V(J)	10V(A)	16V(C)	20V(D)	25V(E)	35V(V)	50V(T)
0.10	104								A	A
0.15	154								A	A/B
0.22	224								A	A/B
0.33	334								A	A/B
0.47	474							A	A/B	A/B/C
0.68	684						A	A	A/B	A/B/C
1.0	105					A	A	A	A/B	A/B/C
1.5	155				A	A	A	A/B	A/B/C	B/C/D
2.2	225			A	A	A/B	A/B	A/B	A/B/C	B/C/D
3.3	335			A	A	A/B	A/B	A/B/C	B/C	C/D
4.7	475		A	A	A/B	A/B	A/B/C	A/B/C	B/C/D	C/D
6.8	685		A	A/B	A/B	A/B/C	A/B/C	B/C	C/D	C/D
10	106		A	A/B	A/B/C	A/B/C	A <sup>(M)</sup> /B/C	B/C/D	C/D/E	D/E/V
15	156		A/B	A/B	A/B/C	A/B/C	B/C/D	C/D	C/D	D/E/V
22	226		A	A/B/C	A/B/C	B/C/D	B/C/D	C/D	D/E	V
33	336	A	A/B	A/B/C	A/B/C/D	B/C/D	C/D	C/D/E	D/E/V	
47	476	A	A/B	A/B/C/D	B/C/D	C/D	C/D/E	D/E	E/V	
68	686	A	A/B/C	B/C/D	B/C/D	C/D	C <sup>(M)</sup> /D/E	D/E/V	V	
100	107	A/B	A/B/C	B/C/D	B/C/D/E	C/D/E	D/E/V	E/V		
150	157	B	B/C	B <sup>(M)</sup> /C/D	C/D/E	D/E/V	E/V	V <sup>(M)</sup>		
220	227	B/D	B/C/D	C/D/E	C/D/E	E/V				
330	337	D	C/D/E	C/D/E	D/E/V	E <sup>(M)</sup>				
470	477	C/D	C/D/E	D/E/V	E/V/U					
680	687	C/D/E	D/E	E/V						
1000	108	D <sup>(M)</sup> /E	D/E/V	E <sup>(M)</sup> /V <sup>(M)</sup>						
1500	158	D/E/V <sup>(M)</sup>	E/V <sup>(M)</sup>							
2200	228	V <sup>(M)</sup>								

注：\*在研产品，<sup>(M)</sup>仅M精度可选

■ 不建议用于新设计，提供更高的电压或更小的外形尺寸替换

# 片式固体钽电容器

TAJ型、TPS型、TAC型片式固体钽电容器



## TPS低ESR型

容量 (μF)	代码	2.5V(e)	4V(G)	6.3V(J)	10V(A)	16V(C)	20V(D)	25V(E)	35V(V)	50V(T)
0.15	154									A(9000)
0.22	224								A(6000)	A(7000)
0.33	334								A(6000)	A(7000)
0.47	474							A(7000)	A(6000) B(4000)	A(6500)B(6000) C(2300)
0.68	684							A(6000)	A(6000)	B(4000)
1.0	105				R(9000)	A(6200)	A(3000)R(6000) S(6000)T(2000)	A(4000) R(2500,4000)	A(3000) B(2000)	B(3000) C(2500)
1.5	155						A(3000)	A(3000) B(1800)	A(3000) B(2500)	C(1500,2000)
2.2	225			R(7000)	A(1800)	A(1800,3500) T(2000)	A(3000) B(1700)	A(2500) B(900,1200,2500)	A(1500) B(750,1500,2000) C(1000)	C(1500) D(1200)
3.3	335			A(2100)	T(1500)	A(3500) B(2500)	A(2500) B(1300)	A(1000,1500) B(750,1500,2000)	B(1000) C(700)	C(1000) D(800)
4.7	475			S(4000)	A(1400)B(1400) R(3000,5000)	A(2000) B(800,1500)	A(1800) B(750,1000)	B(700,900,1500) C(700)	B(700,1500) C(600)D(700)	C(800) D(250,300,500,700)
6.8	685			A(1800)	A(1800)B(1300) T(1800)	A(1500) B(600,1200)	A(1000) B(600,1000) C(700)	B(700) C(500,600,700)	C(350) D(150,400,500)	D(200,300,500,600)
10	106		R(3000)	A(1500)B(1500) R(1000,1500,3000) T(1000)	A(900,1800)B(1000) P(2000)M(500) S(900) T(1000,2000)	A(1000)B(500,800) C(500)T(800,1000) W(500,600)	B(500,1000) C(500,700) W(250,500)	B(1800) C(300,500) D(500)	C(600) D(125,300)E(200) Y(250)	D(500) E(250,300,400,500)
15	156			A(700,1500)	A(1000) B(450,600)C(700) T(1200)	B(500,800) C(300,700)	B(500) C(400,450)	C(220,300) D(100,300)	C(350,450) D(100,300) Y(250)	E(250)V(250)
22	226			A(500,900) B(375,600) C(500)S(900)	A(900) B(400,500,700) C(300)T(800)	B(400,600) C(150,250,300,375) D(700)W(500)	B(400,600) C(100,150,400) D(200,300)	C(275,400) D(100,200,300)	D(125,200,300,400) E(125,200,300) Y(200)	
33	336			A(600) B(250,350,450,600) T(800)	A(700) B(250,425,500,650) C(150,375,500) W(350)	B(350,500) C(100,150,225,300) D(200)W(140,175, 250,400,500) Y(300,400)	C(300) D(100,200)	C(400) D(100,200,300) E(100,175,200,300) Y(200)	D(200,300) E(100,250,300) V(200)	
47	476		A(500)	A(800) B(250,350,500) C(300)T(1200)	B(250,350,500,650) C(200,350) D(100,300) W(125,150,250)	C(110,350) D(80,100,150,200) W(200) X(180)Y(250)	D(75,100,200) E(70,125,150, 200,250) X(200)	D(125,150,250) E(80,100,125) Y(250)	E(200,250) V(150,200)	
68	686			B(250,350,500) C(150,200) W(110,125,250)	B(600) C(80,100,200,300) D(100,150) W(100,150) Y(100,200)	C(125,200) D(70,100,150) F(200)X(150) Y(150,200,250)	D(70,150,200,300) E(125,150,200) Y(200)	D(150,200,300) E(125,200) V(80,95,150,200)	V(150,200)	
100	107		B(200)	B(200,250,350,500) W(100)	B(250,400) C(75,150)D(300) W(100,150) Y(100)	B(400) <sup>M</sup> C(75,100,150,200) D(50,65,80,100,125, 150)E(125)W(150) X(85,150,200) Y(100,150,200)	C(200) D(60,100,125,150) E(55,100,125,150) F(150,200) <sup>M</sup> Y(100,150,200)	D(85,100,150) E(100,150,200) V(60,85,100,200)	E(150) V(100)	
150	157		B(150)	B(250) C(70,80)	C(50,90,150,200,250) D(50,125) Y(40,50)	C(150)D(50,85,100) E(100)F(200)X(100) <sup>M</sup> Y(100,150,200)	D(60,85,100,125,150) E(100)V(45,75) Y(200) <sup>M</sup>	V(80)	V(150) <sup>M</sup>	
220	227		B(150,200,600) D(45)	D(40,50,100) Y(40,50,75)	C(70,100,125,250) D(60,100,125) E(100)F(200) Y(100,150)	D(40,50,100,150) E(50,60,70,100, 125,150) Y(100,150,200)	E(100,150) V(50,75,100,150)			
330	337		Y(40)	C(100) D(35,45,100) F(200) X(100)	C(80,100) D(45,50,70,100) E(50,100,125,150) V(100) Y(75,100,150)	D(50,65,100,150) E(40,50,60,100) V(40,60,100)	E(200) <sup>M</sup>			
470	477		D(35) F(200) Y(100)	D(45,100) E(35,45,100)	D(45,60,100,200) E(45,50,60,100,200) V(40,55,100)Y(150)	E(45,50,60,100,200) V(40,60,100)				
680	687		D(35,50) E(35,50) Y(100)	D(45,60,100) E(40,60,100)	E(45,60,100) V(35,40,50)					
1000	108		E(30,40) Y(100) <sup>M</sup>	E(40,60) V(25,35,40,50)	E(100) <sup>M</sup> V(40,50) <sup>M</sup>					
1500	158		D(100) E(50) V(30,40) <sup>M</sup>	E(50,75) V(50,75) <sup>M</sup>						

注: <sup>M</sup>仅M精度可选, ESR值单位: mΩ  
 ■ 不建议用于新设计, 提供更高的电压或更小的外形尺寸替换  
 ■ 工程样品, 请联系原厂



# 片式固体钽电容器

TAJ型、TPS型、TAC型片式固体钽电容器



## TAC超薄型

容量 ( $\mu$ F)	代码	2.0V	3.0V	4.0V	6.3V	10V	16V	20V	25V
0.10 0.15 0.22	104 154 224					K K	K K K	K	
0.33 0.47 0.68	334 474 684					K K/L K/L	K L L		
1.0 1.5 2.2	105 155 225		K/L	L L	K/L L K/L	K/L/R L L/U	L/U L		R
3.3 4.7 6.8	335 475 685	K/L K/L K/L	K/L K/L L	L L/U L	L/U L L/R	L/R L/R L/R		R R	
10 15 22	106 156 226	K/L/U R	L R L/R	L/R/J L/R L/R	L/R/I L/R/H R/H	L/R/H/V R/V R	R		
33 47 68	336 476 686	R R R	R R/H A/R	R/H R A	R A/R T	A/R B/T			
100 150 220	107 157 227	A	A/R	A/R	A/T				

## 标准包装

外形代码	带式 and 卷式	外形代码	带式 and 卷式	外形代码	带式 and 卷式
A	2,000	R	2,000	K	2,000
B	2,000	S	2,000	L	2,000
C	500	T	2,000	R	2,000
D	500	V	500	H	2,000
E	400	W	500	J	2,000
F	500	X	500	U	2,000
P	2,000	Y	1,500		



片 式 固 定 电 阻 器

# 片式固定电阻器

RC型片式固定电阻器

## 执行标准

总规范: GB/T 5729-2003《电子设备用固定电阻器第1部分:总规范》  
分规范: GB/T 9546-1995《电子设备用固定电阻器第8部分:分规范》



## 产品特点

- ① 信赖性高: 选用金属厚膜工艺, 采用玻璃釉保护层及三层电镀端头结构, 可靠性高。
- ② 装配性好: 外观尺寸均匀精确, 易于装配。

## 产品应用

- ① 大功率系列: 应用于电源开关、DC-DC转换器、DC-AC、AC-DC变换器, 替代引线功率电阻。
- ② 低阻值系列: 应用于电流感应、电路保护、取样电路、电源供应、切换开关等。
- ③ 高精度系列: 应用于电源供应、开关、硬盘、精密仪器及工业产品精密电路。

## 选用示例

RC	0805	1001	B	T
片阻型号	外形尺寸	标称阻值	允许偏差	包装方式
	0201(1/20W) 0402(1/16W) 0603(1/10W) 0805(1/8W) 1206(1/4W) 1210(1/3W) 2010(1/2W) 2512(1W) (70°C额定功率)	10mΩ~910mΩ 1Ω~10MΩ E24系列 三位数表示 例: 000=0.00Ω 1R5=1.5Ω 100=10Ω 102=1.0kΩ 105=1MΩ E96、E192系列 四位数表示 例: R050=0.05Ω 22R1=22.1Ω 1020=102Ω 1542=15.4kΩ	B=±1% D=±5% F=±1% J=±5%	T=7"盘纸带包装 V=7"盘塑料带包装

## 技术参数

项目	5%性能		1% 1% 5%性能		试验方法
温度系数	≤ ±200ppm/°C		≤ ±50ppm/°C ±100ppm/°C ±200ppm/°C		-55°C~+125°C
温度循环	≤ ±(2%+0.1Ω)		≤ ±(0.5%+0.005Ω)		-55°C~+125°C 5次循环
短时过载	≤ ±(0.5%+0.05Ω)		≤ ±(0.5%+0.005Ω)		2.5倍额定电压(V=√P×R)或 2倍极限工作电压, 取较小者, 5秒
耐焊接热	≤ ±(0.5%+0.05Ω)		≤ ±(0.5%+0.005Ω)		260°C 10秒
绝缘电阻	≥ 10,000MΩ		≥ 10,000MΩ		600V 60秒
可焊性	覆盖面积≥95%		覆盖面积≥95%		230°C ±5°C 5秒
潮湿负载	≤ ±(2%+0.05Ω)		≤ ±(0.5%+0.005Ω)		40°C 95%RH 14小时
负载寿命	≤ ±(2%+0.05Ω)		≤ ±(1%+0.005Ω)		70°C 1000小时
端头强度	≤ ±(0.5%+0.05Ω)		≤ ±(0.5%+0.005Ω)		拉力1000g 30秒
工作电压	0201 25VDC	0402、0603 50VDC	0805 150VDC	1206、1210、2010、2512	200VDC
过载电压	0201 50VDC	0402、0603 100VDC	0805 300VDC	1206、1210、2010、2512	400VDC

# 片式固定电阻器

RC型片式固定电阻器



## 标准品系列

型号 (70°C额定功率)	精度	阻值范围(详见系列阻值表)	温度系数(ppm/°C)
0201(1/20W)	±5%(E24) (0Ω: <50mΩ)	1Ω~3.92Ω	+600~-200
		4.02Ω~9.76Ω	+350~-100
0Ω, 10Ω~10MΩ		±200	
0Ω, 1Ω~10MΩ			
0Ω, 1Ω~10MΩ			
0Ω, 1Ω~10MΩ			
0Ω, 1Ω~10MΩ			
0Ω, 1Ω~10MΩ			
0Ω, 1Ω~10MΩ			
0Ω, 1Ω~10MΩ			
2512(1W)	0Ω, 1Ω~10MΩ		

※注: 0Ω: 0201、0402、0603尺寸最大阻值Rmax<50mΩ, 额定电流I<sub>R</sub>≤1A; 0805、1206、1210、2010、2512尺寸最大阻值Rmax<50mΩ, 额定电流I<sub>R</sub>≤2A

## 高精度系列

型号 (70°C额定功率)	阻值范围(详见系列阻值表)			温度系数(ppm/°C)
	±1%(E96)	±5%(E96)	±1%(E96)	
0201(1/20W)			1Ω~3.92Ω	+600~-200
			4.02Ω~9.76Ω	+350~-100
	10Ω~1MΩ	10Ω~1MΩ	10Ω~10MΩ	±200
0402(1/16W)	10Ω~1MΩ	10Ω~1MΩ	10Ω~1MΩ	±200
0603(1/10W)	20Ω~510kΩ	20Ω~510kΩ	20Ω~510kΩ	±50
0805(1/8W)			1Ω~10MΩ	±100
1206(1/4W)			10Ω~1MΩ	±100
2010(1/2W)			1Ω~10MΩ	±100
2512(1W)			1Ω~10MΩ	±100

## 大功率系列

型号 (70°C额定功率)	阻值范围(详见系列阻值表)			温度系数(ppm/°C)
	±1%(E96)	±1%(E24)	5%(E24)	
2010(1W)	1Ω~1MΩ	50mΩ~910mΩ	50mΩ~910mΩ	±100
2512(2W)			1Ω~1MΩ	±200

## 低阻值系列

型号 (70°C额定功率)	精度	阻值范围(详见系列阻值表)	温度系数(ppm/°C)
0603(1/10W)	±1%(E24)	100mΩ~910mΩ	±300
0805(1/8W)		100mΩ~910mΩ	±300
		50mΩ~91mΩ	±400
1206(1/4W)	±5%(E24)	50mΩ~910mΩ	±200
1210(1/3W)		40mΩ~47mΩ	±400
2010(1/2W)		22mΩ~39mΩ	±600
2512(1W)			
		10mΩ~20mΩ	±1000

# 片式固定电阻器

RC型片式固定电阻器

## 系列阻值表

阻值·精度											
1% 0.1%,0.5%	1%,5%	1% 0.1%,0.5%	1%,5%	1% 0.1%,0.5%	1%,5%	1% 0.1%,0.5%	1%,5%	1% 0.1%,0.5%	1%,5%	1% 0.1%,0.5%	1%,5%
(01)100	10	(17)147	—	(33)215	—	(49)316	—	(65)464	—	(81)681	68
(02)102	—	(18)150	15	(34)221	22	(50)324	—	(66)475	47	(82)698	—
(03)105	—	(19)154	—	(35)226	—	(51)332	33	(67)487	—	(83)715	—
(04)107	—	(20)158	—	(36)232	—	(52)340	—	(68)499	—	(84)732	—
(05)110	11	(21)162	—	(37)237	—	(53)348	—	(69)511	51	(85)750	75
(06)113	—	(22)165	—	(38)243	—	(54)357	—	(70)523	—	(86)768	—
(07)115	—	(23)169	—	(39)249	—	(55)365	—	(71)536	—	(87)787	—
(08)118	—	(24)174	—	(40)255	—	(56)374	—	(72)549	—	(88)806	—
(09)121	12	(25)178	—	(41)261	—	(57)383	—	(73)562	56	(89)825	82
(10)124	—	(26)182	—	(42)267	—	(58)392	39	(74)576	—	(90)845	—
(11)127	—	(27)187	—	(43)274	—	(59)402	—	(75)590	—	(91)866	—
(12)130	13	(28)191	—	(44)280	—	(60)412	—	(76)604	—	(92)887	—
(13)133	—	(29)196	—	(45)287	—	(61)422	—	(77)619	62	(93)909	91
(14)137	—	(30)200	20	(46)294	—	(62)432	43	(78)634	—	(94)931	—
(15)140	—	(31)205	—	(47)301	30	(63)442	—	(79)649	—	(95)953	—
(16)143	—	(32)210	—	(48)309	—	(64)453	—	(80)665	—	(96)976	—
E96	E24	E96	E24	E96	E24	E96	E24	E96	E24	E96	E24

## 外形尺寸

规格	尺寸					
	L	W	H	L1	L2	
0201	0.60±0.03	0.30±0.03	0.23±0.03	0.10±0.05	0.15±0.05	
0402	1.00±0.10	0.50±0.10	0.35±0.10	0.20±0.20	0.20±0.20	
0603	1.60±0.10	0.80±0.15	0.45±0.10	0.30±0.20	0.30±0.20	
0805	2.00±0.15	1.20±0.15	0.50±0.10	0.40±0.20	0.40±0.20	
1206	3.10±0.15	1.60±0.15	0.55±0.10	0.50±0.25	0.50±0.25	
1210	3.10±0.15	2.60±0.15	0.55±0.10	0.50±0.25	0.50±0.25	
2010	5.00±0.20	2.50±0.20	0.60±0.10	0.60±0.25	0.60±0.25	
2512	6.30±0.20	3.20±0.20	0.60±0.15	0.60±0.25	0.90±0.25*	

\*大功率系列2512的L2为(1.80±0.25)

## 电阻值表示法

Code	A	B	C	D	E	F	G	H	X	Y	Z
Multiplier	10 <sup>0</sup>	10 <sup>1</sup>	10 <sup>2</sup>	10 <sup>3</sup>	10 <sup>4</sup>	10 <sup>5</sup>	10 <sup>6</sup>	10 <sup>7</sup>	10 <sup>-1</sup>	10 <sup>-2</sup>	10 <sup>-3</sup>



E24(±5%)三位数表示  
例: 100:10Ω      1R5:1.5Ω  
122:1.2kΩ      000:0.0Ω  
473:47kΩ  
105:1MΩ



E96(±1%±1%±5%)四位数表示  
例: 22R1:22.1Ω  
1020:102Ω  
1542:15.4kΩ



E96(±1%±1%±5%)三位数表示  
第三位表示10的n次幂(见上表)  
前两位表示E96系列序号  
例: 02C  
102×10<sup>2</sup>=10.2kΩ





## 多层瓷介固定电容器检验规范

在总规范GB/T2693-2001的规定下，产品检测项目、顺序、检测方法和合格判据按分规范GB/T5966-2011、GB/T5968-2011、GB/T21041-2007、GB/T21042-2007的要求及细则如下：

- (1) 测试条件：温度 $25^{\circ}\text{C} \pm 2^{\circ}\text{C}$ ，气压86~105KPa，相对湿度45~75%；
- (2) 检验细则：

序号	项目	电性能指标	测试条件
1	电容量(C)	允许偏差范围内	
2	损耗角正切值 (tg δ 或Q)	CG: $C_R \leq 30\text{pF}$ $\text{tg } \delta \leq 1/(400+20C_R)$ 或 $Q \geq 400+20C_R$ $C_R > 30\text{pF}$ $\text{tg } \delta \leq 10 \times 10^{-4}$ 或 $Q \geq 1000$ 注: $C_R$ 单位: pF CG(CC48型): $\text{tg } \delta \leq 10 \times 10^{-4}$ 或 $Q \geq 1000$ 2X1、X5R、2F4: $U_R \leq 10\text{V}$ $\text{tg } \delta \leq 1000 \times 10^{-4}$ $U_R = 16\text{V}$ $\text{tg } \delta \leq 700 \times 10^{-4}$ $U_R = 25\text{V}$ $\text{tg } \delta \leq 500 \times 10^{-4}$ $U_R \geq 50\text{V}$ $\text{tg } \delta \leq 350 \times 10^{-4}$ 2X1(CT48型): $\text{tg } \delta \leq 250 \times 10^{-4}$ 注: 0603或0603以下尺寸的2X1、X5R、2F4产品，或者容量大于等于 $1\mu\text{F}$ 的2X1、X5R、2F4产品，损耗角正切值 $\text{tg } \delta \leq 1000 \times 10^{-4}$ 。	测试温度: $25 \pm 2^{\circ}\text{C}$ 测试频率和电压: CG: $C_R \leq 1000\text{pF}$ $1\text{MHz} \pm 10\%$ $0.5\text{V} \sim 5\text{V}$ (有效值) $C_R > 1000\text{pF}$ $1\text{kHz} \pm 10\%$ $1\text{V} \pm 0.2\text{V}$ (有效值) 2X1、X5R、2F4: $C_R \leq 10\mu\text{F}$ $1\text{kHz} \pm 10\%$ $1\text{V} \pm 0.2\text{V}$ (有效值) $C_R > 10\mu\text{F}$ $120\text{Hz} \pm 10\%$ $0.5\text{V} \pm 0.2\text{V}$ (有效值) 测试仪器: HP4284A(开启ALC自动电平控制功能) 测试夹具: HP16334A(适用片式产品)、HP16047A(适用引线产品)
3	介质耐电压	在测试过程中无击穿、飞弧或可见损伤	测试电压: CG、2X1、X5R、2F4: $U_R \leq 200\text{V}$ $3.0U_R$ (CT41G、CT4G型) $U_R \leq 200\text{V}$ $2.5U_R$ $U_R = 250\text{V}$ $2.0U_R$ $U_R = 500\text{V}$ $1.5U_R$ $U_R \geq 630\text{V}$ $1.2U_R$ 测试时间: 5s。 注: 充电/放电电流应小于50毫安。*
4	绝缘电阻 (IR)	CG(CC41、CC4型): $C_R \leq 0.01\mu\text{F}$ $\text{IR} \geq 10^4 \text{M}\Omega$ $C_R > 0.01\mu\text{F}$ $\text{IR} \geq \frac{100}{C_R} \text{M}\Omega$ CG(CC48型): $C_R \leq 0.05\mu\text{F}$ $\text{IR} \geq 10\text{G}\Omega$ $C_R > 0.05\mu\text{F}$ $\text{IR} \geq \frac{500}{C_R} \text{M}\Omega$ 2X1、X5R、2F4(CT41、CT4型): $C_R \leq 0.025\mu\text{F}$ $\text{IR} \geq 4\text{G}\Omega$ $C_R > 0.025\mu\text{F}$ $\text{IR} \geq \frac{100}{C_R} \text{M}\Omega$ 注: $C_R$ 单位: $\mu\text{F}$ 2X1、X5R(CT41G、CT4G型): $C_R \leq 0.025\mu\text{F}$ $\text{IR} \geq 20\text{G}\Omega$ $C_R > 0.025\mu\text{F}$ $\text{IR} \geq \frac{500}{C_R} \text{M}\Omega$ 2X1(CT48型): $C_R \leq 0.05\mu\text{F}$ $\text{IR} \geq 10\text{G}\Omega$ $C_R > 0.05\mu\text{F}$ $\text{IR} \geq \frac{500}{C_R} \text{M}\Omega$ 注: $C_R$ 单位: $\mu\text{F}$ 0201尺寸的2X1、X5R产品，或者部分极限2X1、X5R产品，绝缘电阻指标请以产品规格书为准或咨询火炬电子应用工程部	测试温度: $25 \pm 2^{\circ}\text{C}$ ; 相对湿度: $\leq 70\%$ ; 使用仪器: HP4339A或同惠TH2681A; 测试电压: $U_R < 10\text{V}$ $U_R$ $10 \leq U_R < 100\text{V}$ $10\text{V}$ $100 \leq U_R < 500\text{V}$ $100\text{V}$ $U_R \geq 500\text{V}$ $500\text{V}$ 测试时间: $60\text{s} \pm 5\text{s}$ 。 注: 充电/放电电流应小于50毫安。*
5	可焊性	着焊部不少于90%的面积覆盖涂层	样品应在 $80^{\circ}\text{C} \sim 140^{\circ}\text{C}$ 下进行预加热并维持30s~60s 温度: $235^{\circ}\text{C} \pm 5^{\circ}\text{C}$ ; 浸渍时间: $2\text{s} \pm 0.2\text{s}$ ; 浸渍深度: 10mm; 浸渍次数: 1次。
6	耐焊接热	外观无损伤 $\Delta C$ : CG: $\leq \pm 2.5\%$ 或 $\pm 2.5\text{pF}$ 取较大者 2X1: $\leq \pm 7.5\%$ X5R: $\leq \pm 7.5\%$ 2F4: $\leq \pm 20\%$ $Q$ 或 $\text{tg } \delta$ : 应满足初始值要求 IR: 应满足初始值要求	样品应在 $110^{\circ}\text{C} \sim 140^{\circ}\text{C}$ 下进行预加热并维持30s~60s 温度: $260^{\circ}\text{C} \pm 5^{\circ}\text{C}$ ; 浸渍时间: $10\text{s} \pm 1\text{s}$ ; 浸渍深度: 10mm; 浸渍次数: 1次。 在进行上述试验之后，试验样品将保持在室温静放 $24 \pm 2$ 小时(CG)或 $48 \pm 4$ 小时(2X1、X5R、2F4)，然后再进行测试。



序号	项目	电性能指标	测试条件	
7	温度快速变化	外观无损伤	预处理: 150°C 1小时 (2X1、X5R、2F4) $T_A = +125^\circ\text{C}$ $T_B = -55^\circ\text{C}$ 5次循环 持续时间: $t_1 = 30\text{min}$ 在进行上述试验之后, 试验样品将保持在室温静放 $24 \pm 2$ 小时 (CG)或 $48 \pm 4$ 小时 (2X1、X5R、2F4), 然后再进行测试。	
		$\Delta C$		CG: $\leq \pm 2.5\%$ 或 $\pm 2.5\text{pF}$ 取较大者 2X1: $\leq \pm 7.5\%$ X5R: $\leq \pm 7.5\%$ 2F4: $\leq \pm 20\%$
		Q或tg $\delta$		应满足初始值要求
		IR		应满足初始值要求
8	稳态湿热	外观无损伤	预处理: 150°C 1小时 (2X1、X5R、2F4) 温度: $60^\circ\text{C} \pm 2^\circ\text{C}$ (CG) $40^\circ\text{C} \pm 2^\circ\text{C}$ (2X1、X5R、2F4) 湿度: 90%~95%RH 时间: $500 \frac{1}{2}$ 小时 在进行上述试验之后, 试验样品将保持在室温静放 $24 \pm 2$ 小时 (CG)或 $48 \pm 4$ 小时 (2X1、X5R、2F4), 然后再进行测试。	
		$\Delta C$		CG: $\leq \pm 5\%$ 或 $\pm 0.5\text{pF}$ 取较大者 2X1: $\leq \pm 12.5\%$ X5R: $\leq \pm 12.5\%$ 2F4: $\leq \pm 30\%$
		Q或tg $\delta$		CG: $C < 10\text{pF}, Q \geq 200+10\text{C};$ $10\text{pF} \leq C < 30\text{pF}, Q \geq 275+2.5\text{C};$ $C \geq 30\text{pF}, Q \geq 350$ 2X1: tg $\delta \leq 500 \times 10^{-4}$ 或规定值的150%取较大者 X5R: tg $\delta \leq 500 \times 10^{-4}$ 或规定值的150%取较大者 2F4: tg $\delta \leq 700 \times 10^{-4}$ 或规定值的200%取较大者
		IR		1000M $\Omega$ 或50M $\Omega \cdot \mu\text{F}$ , 取较小者
9	耐久性	外观无损伤	温度: $125^\circ\text{C} \pm 3^\circ\text{C}$ (CG、2X1) $85^\circ\text{C} \pm 2^\circ\text{C}$ (X5R、2F4) $U_r \leq 200\text{V}$ 施加电压: $1.5U_r$ 持续时间: 1000h $200\text{V} < U_r \leq 500\text{V}$ 施加电压: $1.3U_r$ 持续时间: 1500h $U_r > 500\text{V}$ 施加电压: $1.2U_r$ 持续时间: 2000h 在进行上述试验之后, 试验样品将保持在室温静放 $24 \pm 2$ 小时 (CG)或 $48 \pm 4$ 小时 (2X1、X5R、2F4), 然后再进行测试。	
		$\Delta C$		CG: $\leq \pm 3\%$ 或 $\pm 0.3\text{pF}$ 取较大者 2X1: $\leq \pm 12.5\%$ X5R: $\leq \pm 12.5\%$ 2F4: $\leq \pm 30\%$
		Q或tg $\delta$		CG: $C < 10\text{pF}, Q \geq 200+10\text{C};$ $10\text{pF} \leq C < 30\text{pF}, Q \geq 275+2.5\text{C};$ $C \geq 30\text{pF}, Q \geq 350$ 2X1: tg $\delta \leq 500 \times 10^{-4}$ 或规定值的150%取较大者 X5R: tg $\delta \leq 500 \times 10^{-4}$ 或规定值的150%取较大者 2F4: tg $\delta \leq 700 \times 10^{-4}$ 或规定值的200%取较大者
		IR		500M $\Omega$ 或25M $\Omega \cdot \mu\text{F}$ , 取较小者

\*如果不能判定“充电/放电电流小于50毫安”, 建议串入一只可调电阻及电流表观察。

为了帮助用户快速设计产品，凡本手册所列品种、规格，均可提供免费样品。(宇航级产品除外)

一、免费样品请使用《火炬电子免费样品联络单》与本司联系，以确保您快速、准确的收到样品。

二、火炬电子应用工程部为您提供专业的技术服务，部分项目如下：

- 4008-878799免费服务热线，为用户解答陶瓷电容的选型、使用、检测、判定、焊接工艺、储存及故障排除等电容器技术问题。
  - 免费产品失效分析（FA）；包括电容器DPA（结构、材料分析）、电性能测试，提供相应报告。
- 更多、更新的服务项目，请联络火炬电子或访问www.torch.cn。

(请复印后填写，以便多次索样)

### 火炬电子免费样品联络单

姓名：\_\_\_\_\_ 电话：\_\_\_\_\_ 移动电话：\_\_\_\_\_

地址：\_\_\_\_\_ 邮编：\_\_\_\_\_

单位名称：\_\_\_\_\_ 传真：\_\_\_\_\_

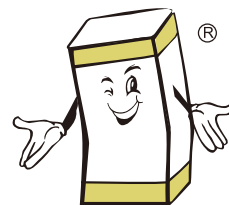

阳光网秘

样品描述	型号/规格 (或性能要求)	数量
	1. _____	_____
	2. _____	_____
	3. _____	_____
	4. _____	_____
	5. _____	_____

电容专家<sup>®</sup>、阳光网秘<sup>®</sup>是火炬电子注册之服务品牌，面向客户提供免费样品、价格、货期、运输查询、订单执行进度等业务接口服务，以及专业的技术服务，欢迎访问www.torch.cn登录会员专区了解详情。

客户服务&业务联络：4008-878799，0595-2248 5280，cs@torch.cn

技术支持：0595-2235 0265，2235 3697，ts@torch.cn

传 真：0595-2235 3675，2235 3676 地址：福建省泉州市鲤城区江南高新技术电子信息园区紫华路4号 (362000)

[www.torch.cn](http://www.torch.cn)



## 2017火炬电子产品选型指南换版说明

手册名称	2017火炬电子产品选型指南	更改前编号	TH001-H-1607
更改日期	2016年10月01日	更改后编号	TH001-I-1610

序号	类型	更改(新增)项目	更改内容摘要	相关页码/章节
1	修订	应用指南-片式产品的手工焊接描述	<p>根据产品特性及行业应用情况调整片式产品手工焊接描述:</p> <p>(1)焊接前, 先将电容器和基板逐渐预热至100℃~125℃;</p> <p>(2)手工焊一般选用功率20W的电烙铁为宜, 烙铁头直径不超过3mm, 烙铁头尖端不大于1mm;</p> <p>(3)焊接非接地焊盘时, 焊接温度一般设置为260℃~280℃, 焊接接地焊盘时, 焊接温度一般设置280℃~300℃, 焊接时间不超过3s;</p> <p>(4)烙铁头不允许碰触电容器本体, 电容器的一端焊后发现电容器翘起不平, 必须将原焊点熔开后方可整平, 切勿以烙铁头在电容器上直接加热整平(见图1、图2);</p> <p>(5)焊接后自然冷却, 请勿风冷; 急热、急冷均容易造成裂痕或损伤;</p> <p>(6)推荐使用环保型免清洗焊料、助焊剂;</p> <p>(7)特别提醒: 电容器与基板之间的多余杂质会形成跨接电阻, 影响电容器性能(见图3)。</p>	Page11
2	新增	CT45型模压表贴瓷介电容器(A/B壳)	<p>新增火炬电子 CT45型模压表贴瓷介电容器(A、B壳)产品章节内容</p>	Page43~ Page46
3	修订/新增	片式固体钽电容器容量范围	<p>修订/新增片式固体钽电容部分型号规格 (TAJ系列/TPS系列/TAC系列)</p>	Page48~52



---

#### 北京分公司

地址：北京市丰台区南四环西路188号七区23号楼(总部基地园区)  
电话：010-6879 7978 010-6879 7976 传真：010-6879 7977

---

#### 西安分公司

地址：西安市科技路37号海星城市广场A座1011室  
电话：029-8834 8015 传真：029-8834 8013

---

#### 上海办事处

地址：上海市徐汇区田林路140号SVA越界创意园区28号楼1楼G30室  
电话：021-5424 2486 传真：021-5424 2486

---

#### 成都办事处

地址：成都市青羊区贝森北路1号西村大院一栋401-7  
电话：028-8746 5767 传真：028-8753 5767

---

#### 武汉办事处

地址：武汉市东湖新技术开发区关山大道111号武汉光谷国际商务中心A栋15层07室  
电话：027-8737 3911 传真：027-8737 3911

---

#### 洛阳办事处

地址：河南省洛阳市西工区凯旋路19号院一品翰景小区 二单元2403室  
电话：0379-6362 0189 传真：0379-6362 0189

---

#### 合肥办事处

地址：合肥市高新区海关路与天柱路交叉口幸福里程小区3栋2902室  
电话：0551-6556 8820 传真：0551-6556 8820

---

#### 天津办事处

地址：天津市东丽区空港经济区东二道yoho湾瑞航广场7号楼8号门407  
电话：022-8438 1818 传真：022-8438 1818

---

#### 南京办事处

地址：南京市雨花区绿地之窗商务广场C1-927  
电话：025-5187 7065 传真：025-5187 7065

---



欢迎关注火炬官方微信



欢迎下载火炬选型软件

### 福建火炬电子科技股份有限公司

FUJIAN TORCH ELECTRON TECHNOLOGY CO., LTD.

地 址：福建省泉州市鲤城区江南高新技术电子信息园区紫华路4号 (362000)

客户服务：4008-878799 0595-2248 5280 技术支持：0595-2235 0265 2235 3697

传 真：0595-2235 3675 2235 3676 网 址：www.torch.cn 邮 箱：cs@torch.cn