



## 79DXXA

## LINEAR INTEGRATED CIRCUIT

### 3 TERMINAL 1A NEGATIVE VOLTAGE REGULATOR

#### DESCRIPTION

The UTC **79DXXA** series of three-terminal negative regulators is available several fixed output voltage, making them useful in a wide range of application. Each type employs internal current limiting, thermal shut-down, making it essentially indestructible.

#### FEATURES

- \* Output current up to 1A
- \* -5V, -6V, -8V, -9V, -12V, -15V, -18V, -24V output voltage available
- \* Thermal overload protection

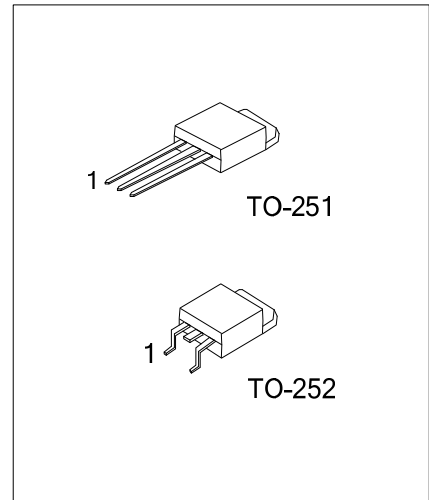

#### NORDERING INFORMATIO

Ordering Number		Package	Pin Assignment			Packing
Lead Free	Halogen Free		1	2	3	
79DXXAL-TM3-T	79DXXAG-TM3-T	TO-251	G	I	O	Tube
79DXXAL-TN3-T	79DXXAG-TN3-T	TO-252	G	I	O	Tube
79DXXAL-TN3-R	79DXXAG-TN3-R	TO-252	G	I	O	Tape Reel

Note: Pin Assignment : G: GND I: Input O: Output

<p>79DXXAL-TM3-T</p>	<p>(1) T: Tube, R: Tape Reel</p> <p>(2) TM3: TO-251, TN3: TO-252</p> <p>(3) L: Lead Free, G: Halogen Free</p> <p>(4) xx: refer to Marking Information</p>
----------------------	---

## MARKING INFORMATION

PACKAGE	VOLTAGE CODE	MARKING
TO-251 TO-252	05: -5V	
	06: -6V	
	08: -8V	
	09: -9V	
	12: -12V	
	15: -15V	
	18: -18V	
24: -24V		

## BLOCK DIAGRAM

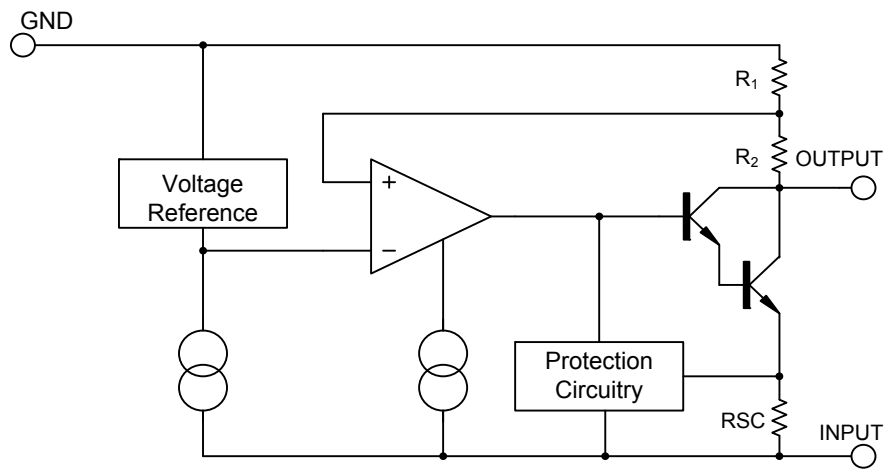

■ ABSOLUTE MAXIMUM RATINGS (T<sub>A</sub>=25°C)

PARAMETER	SYMBOL	RATING	UNIT
Input Voltage	V <sub>IN</sub>	-35	V
Output Current	I <sub>OUT</sub>	1	A
Power Dissipation	P <sub>D</sub>	Internally Limited	W
Operating Temperature	T <sub>OPR</sub>	0 ~ +125	°C
Storage Temperature	T <sub>STG</sub>	-65 ~ +150	°C

Note: Absolute maximum ratings are those values beyond which the device could be permanently damaged.

Absolute maximum ratings are stress ratings only and functional device operation is not implied.

■ THERMAL DATA

PARAMETER	SYMBOL	RATING	UNIT
Junction to Ambient	θ <sub>JA</sub>	112	°C/W
Junction to Case	θ <sub>JC</sub>	12.5	°C/W

■ ELECTRICAL CHARACTERISTICS

(I<sub>OUT</sub>=0.5A, T<sub>J</sub>=0°C~125°C, C<sub>I</sub>=2.2uF, C<sub>O</sub>=1uF, unless otherwise specified)

For UTC 79D05A (V<sub>IN</sub>=-10V)

PARAMETER	SYMBOL	TEST CONDITIONS	MIN	TYP	MAX	UNIT
Output Voltage	V <sub>OUT</sub>	T <sub>J</sub> =25°C	-4.80	-5.0	-5.20	V
		V <sub>IN</sub> =-7V~-20V I <sub>OUT</sub> =5mA~1A, P <sub>D</sub> ≤ 15W	-4.75		-5.25	V
Dropout Voltage	V <sub>D</sub>	I <sub>OUT</sub> =1A T <sub>J</sub> =25°C		2		V
Line Regulation	ΔV <sub>OUT</sub>	V <sub>IN</sub> =-7V~-25V T <sub>J</sub> =25°C		10	100	mV
		V <sub>IN</sub> =-8V~-12V T <sub>J</sub> =25°C		5	60	mV
Load Regulation	ΔV <sub>OUT</sub>	I <sub>OUT</sub> =5mA~1A T <sub>J</sub> =25°C		10	100	mV
		I <sub>OUT</sub> =250mA~750mA T <sub>J</sub> =25°C		3	50	mV
Quiescent Current	I <sub>Q</sub>	T <sub>J</sub> =25°C		3	6	mA
Quiescent Current Change	ΔI <sub>Q</sub>	I <sub>OUT</sub> =5mA~1A		0.05	0.5	mA
		V <sub>IN</sub> =-7V~-25V		0.1	1.3	mA
Output Noise Voltage	eN	f=10Hz~100kHz T <sub>A</sub> =25°C		100		μV
Output Voltage Drift	ΔV <sub>OUT</sub> /ΔT	I <sub>OUT</sub> =5mA		-0.4		mV/°C
Ripple Rejection	RR	V <sub>IN</sub> =-8V~-18V, f=120Hz	54	60		dB
Peak Current	I <sub>PEAK</sub>	T <sub>J</sub> =25°C		2.2		A

For UTC 79D06A (V<sub>IN</sub>=-11V)

PARAMETER	SYMBOL	TEST CONDITIONS	MIN	TYP	MAX	UNIT
Output Voltage	V <sub>OUT</sub>	T <sub>J</sub> =25°C	-5.76	-6.00	-6.24	V
		V <sub>IN</sub> =-8V~-21V, I <sub>OUT</sub> =5mA~1A, P <sub>D</sub> ≤ 15W	-5.70		-6.30	V
Dropout Voltage	V <sub>D</sub>	I <sub>OUT</sub> =1.0A T <sub>J</sub> =25°C		2		V
Line Regulation	ΔV <sub>OUT</sub>	V <sub>IN</sub> =-8V~-25V T <sub>J</sub> =25°C		10	120	mV
		V <sub>IN</sub> =-9V~-13V T <sub>J</sub> =25°C		5	60	mV
Load Regulation	ΔV <sub>OUT</sub>	I <sub>OUT</sub> =5mA~1A T <sub>J</sub> =25°C		10	120	mV
		I <sub>OUT</sub> =250mA~750mA T <sub>J</sub> =25°C		3	60	mV
Quiescent Current	I <sub>Q</sub>	T <sub>J</sub> =25°C		3	6	mA
Quiescent Current Change	ΔI <sub>Q</sub>	I <sub>OUT</sub> =5mA~1A		0.05	0.5	mA
		V <sub>IN</sub> =-8V~-25V		0.1	1.3	mA
Output Noise Voltage	eN	f=10Hz~100kHz T <sub>A</sub> =25°C		130		μV

## ■ ELECTRICAL CHARACTERISTICS(Cont.)

PARAMETER	SYMBOL	TEST CONDITIONS	MIN	TYP	MAX	UNIT
Output Voltage Drift	$\Delta V_{OUT}/\Delta T$	$I_{OUT}=5mA$		-0.5		mV/°C
Ripple Rejection	RR	$V_{IN}=-9V\sim-19V$ , $f=120Hz$	54	60		dB
Peak Current	$I_{PEAK}$	$T_J=25^\circ C$		2.2		A

For UTC 79D08A ( $V_{IN}=-14V$ )

PARAMETER	SYMBOL	TEST CONDITIONS	MIN	TYP	MAX	UNIT
Output Voltage	$V_{OUT}$	$T_J=25^\circ C$	-7.68	-8.0	-8.32	V
		$V_{IN}=-10.5V\sim-23V$ , $I_{OUT}=5mA\sim 1A$ , $P_D \leq 15W$	-7.60		-8.40	V
Dropout Voltage	$V_D$	$I_{OUT}=1A$ , $T_J=25^\circ C$		2		V
Line Regulation	$\Delta V_{OUT}$	$V_{IN}=-10.5V\sim-25V$ , $T_J=25^\circ C$		10	160	mV
		$V_{IN}=-11.5V\sim-17V$ , $T_J=25^\circ C$		5	80	mV
Load Regulation	$\Delta V_{OUT}$	$I_{OUT}=5mA\sim 1A$ , $T_J=25^\circ C$		12	160	mV
		$I_{OUT}=250mA\sim 750mA$ , $T_J=25^\circ C$		4	80	mV
Quiescent Current	$I_Q$	$T_J=25^\circ C$		3	6	mA
Quiescent Current Change	$\Delta I_Q$	$I_{OUT}=5mA\sim 1A$		0.05	0.5	mA
		$V_{IN}=-11.5V\sim-25V$		0.1	1.0	mA
Output Noise Voltage	eN	$f=10Hz\sim 100kHz$ , $T_A=25^\circ C$		175		$\mu V$
Output Voltage Drift	$\Delta V_{OUT}/\Delta T$	$I_{OUT}=5mA$		-0.6		mV/°C
Ripple Rejection	RR	$V_{IN}=-11.5V\sim-21.5V$ , $f=120Hz$	54	60		dB
Peak Current	$I_{PEAK}$	$T_J=25^\circ C$		2.2		A

For UTC 79D09A ( $V_{IN}=-15V$ )

PARAMETER	SYMBOL	TEST CONDITIONS	MIN	TYP	MAX	UNIT
Output Voltage	$V_{OUT}$	$T_J=25^\circ C$	-8.64	-9.0	-9.36	V
		$V_{IN}=-11.5V\sim-23V$ , $I_{OUT}=5mA\sim 1A$ , $P_D \leq 15W$	-8.55		-9.45	V
Dropout Voltage	$V_D$	$I_{OUT}=1A$ , $T_J=25^\circ C$		2.0		V
Line Regulation	$\Delta V_{OUT}$	$V_{IN}=-11.5V\sim-26V$ , $T_J=25^\circ C$		10	180	mV
		$V_{IN}=-12V\sim-18V$ , $T_J=25^\circ C$		5	90	mV
Load Regulation	$\Delta V_{OUT}$	$I_{OUT}=5mA\sim 1A$ , $T_J=25^\circ C$		12	180	mV
		$I_{OUT}=250mA\sim 750mA$ , $T_J=25^\circ C$		4	90	mV
Quiescent Current	$I_Q$	$T_J=25^\circ C$		3	6	mA
Quiescent Current Change	$\Delta I_Q$	$I_{OUT}=5mA\sim 1A$		0.05	0.5	mA
		$V_{IN}=-11.5V\sim-26V$		0.1	1.0	mA
Output Noise Voltage	eN	$f=10Hz\sim 100kHz$ , $T_a=25^\circ C$		175		$\mu V$
Output Voltage Drift	$\Delta V_{OUT}/\Delta T$	$I_{OUT}=5mA$		-0.6		mV/°C
Ripple Rejection	RR	$V_{IN}=-12.5V\sim-22.5V$ , $f=120Hz$	54	60		dB
Peak Current	$I_{PEAK}$	$T_J=25^\circ C$		2.2		A

■ ELECTRICAL CHARACTERISTICS(Cont.)

For UTC 79D12A ( $V_{IN}=-18V$ )

PARAMETER	SYMBOL	TEST CONDITIONS	MIN	TYP	MAX	UNIT
Output Voltage	$V_{OUT}$	$T_J=25^{\circ}C$	-11.52	-12.0	-12.48	V
		$V_{IN}=-14.5V\sim-27V$ , $I_{OUT}=5mA\sim 1A$ , $P_D\leq 15W$	-11.40		-12.60	V
Dropout Voltage	$V_D$	$I_{OUT}=1A$ , $T_J=25^{\circ}C$		2		V
Line Regulation	$\Delta V_{OUT}$	$V_{IN}=-14.5V\sim-30V$ , $T_J=25^{\circ}C$		12	240	mV
		$V_{IN}=-16V\sim-22V$ , $T_J=25^{\circ}C$		6	120	mV
Load Regulation	$\Delta V_{OUT}$	$I_{OUT}=5mA\sim 1A$ , $T_J=25^{\circ}C$		12	240	mV
		$I_{OUT}=250mA\sim 750mA$ , $T_J=25^{\circ}C$		4	120	mV
Quiescent Current	$I_Q$	$T_J=25^{\circ}C$		3	6	mA
Quiescent Current Change	$\Delta I_Q$	$I_{OUT}=5mA\sim 1A$		0.05	0.5	mA
		$V_{IN}=-14.5V\sim-30V$		0.1	1.0	mA
Output Noise Voltage	eN	$f=10Hz\sim 100kHz$ , $T_a=25^{\circ}C$		200		$\mu V$
Output Voltage Drift	$\Delta V_{OUT}/\Delta T$	$I_{OUT}=5mA$		-0.8		$mV/^{\circ}C$
Ripple Rejection	RR	$V_{IN}=-15V\sim-25V$ , $f=120Hz$	54	60		dB
Peak Current	$I_{PEAK}$	$T_J=25^{\circ}C$		2.2		A

For UTC 79D15A ( $V_{IN}=-23V$ )

PARAMETER	SYMBOL	TEST CONDITIONS	MIN	TYP	MAX	UNIT
Output Voltage	$V_{OUT}$	$T_J=25^{\circ}C$	-14.40	-15.0	-15.60	V
		$V_{IN}=-17.5V\sim-30V$ , $I_{OUT}=5mA\sim 1A$ , $P_D\leq 15W$	-14.25		-15.75	V
Dropout Voltage	$V_D$	$I_{OUT}=1A$ , $T_J=25^{\circ}C$		2		V
Line Regulation	$\Delta V_{OUT}$	$V_{IN}=-17.5V\sim-30V$ , $T_J=25^{\circ}C$		12	300	mV
		$V_{IN}=-20V\sim-26V$ , $T_J=25^{\circ}C$		6	150	mV
Load Regulation	$\Delta V_{OUT}$	$I_{OUT}=5mA\sim 1A$ , $T_J=25^{\circ}C$		12	300	mV
		$I_{OUT}=250mA\sim 750mA$ , $T_J=25^{\circ}C$		4	150	mV
Quiescent Current	$I_Q$	$T_J=25^{\circ}C$		3	6	mA
Quiescent Current Change	$\Delta I_Q$	$I_{OUT}=5mA\sim 1A$		0.05	0.5	mA
		$V_{IN}=-17.5V\sim-30.5V$		0.1	1.0	mA
Output Noise Voltage	eN	$f=10Hz\sim 100kHz$ , $T_a=25^{\circ}C$		250		$\mu V$
Output Voltage Drift	$\Delta V_{OUT}/\Delta T$	$I_{OUT}=5mA$		-0.9		$mV/^{\circ}C$
Ripple Rejection	RR	$V_{IN}=-18.5V\sim-28.5V$ , $f=120Hz$	54	60		dB
Peak Current	$I_{PEAK}$	$T_J=25^{\circ}C$		2.2		A

■ ELECTRICAL CHARACTERISTICS(Cont.)

For UTC 79D18A ( $V_{IN}=-27V$ )

PARAMETER	SYMBOL	TEST CONDITIONS	MIN	TYP	MAX	UNIT
Output Voltage	$V_{OUT}$	$T_J=25^{\circ}C$	-17.28	-18.0	-18.72	V
		$V_{IN}=-21V\sim-33V$ $I_{OUT}=5mA\sim 1A, P_D \leq 15W$	-17.10		-18.90	V
Dropout Voltage	$V_D$	$I_{OUT}=1A$ $T_J=25^{\circ}C$		2		V
Line Regulation	$\Delta V_{OUT}$	$V_{IN}=-21V\sim-33V$ $T_J=25^{\circ}C$		15	360	mV
		$V_{IN}=-24V\sim-30V$ $T_J=25^{\circ}C$		8	180	mV
Load Regulation	$\Delta V_{OUT}$	$I_{OUT}=5mA\sim 1A$ $T_J=25^{\circ}C$		15	360	mV
		$I_{OUT}=250mA\sim 750mA$ $T_J=25^{\circ}C$		5.0	180	mV
Quiescent Current	$I_Q$	$T_J=25^{\circ}C$		3	6	mA
Quiescent Current Change	$\Delta I_Q$	$I_{OUT}=5mA\sim 1A$		0.05	0.5	mA
		$V_{IN}=-21V\sim-32V$		0.1	1.0	mA
Output Noise Voltage	eN	$f=10Hz\sim 100kHz$ $T_a=25^{\circ}C$		300		$\mu V$
Output Voltage Drift	$\Delta V_{OUT}/\Delta T$	$I_{OUT}=5mA$		-1		$mV/^{\circ}C$
Ripple Rejection	RR	$V_{IN}=-22V\sim-32V, f=120Hz$	54	60		dB
Peak Current	$I_{PEAK}$	$T_J=25^{\circ}C$		2.2		A

For UTC 79D24A ( $V_{IN}=-33V$ )

PARAMETER	SYMBOL	TEST CONDITIONS	MIN	TYP	MAX	UNIT
Output Voltage	$V_{OUT}$	$T_J=25^{\circ}C$	-23.04	-24	-24.96	V
		$V_{IN}=-27V\sim-38V$ $I_{OUT}=5mA\sim 1A, P_D \leq 15W$	-22.80		-25.20	V
Dropout Voltage	$V_D$	$I_{OUT}=1.0A$ $T_J=25^{\circ}C$		2		V
Line Regulation	$\Delta V_{OUT}$	$V_{IN}=-27V\sim-38V$ $T_J=25^{\circ}C$		15	480	mV
		$V_{IN}=-30V\sim-36V$ $T_J=25^{\circ}C$		8	240	mV
Load Regulation	$\Delta V_{OUT}$	$I_{OUT}=5mA\sim 1A$ $T_J=25^{\circ}C$		15	480	mV
		$I_{OUT}=250mA\sim 750mA$ $T_J=25^{\circ}C$		5.0	240	mV
Quiescent Current	$I_Q$	$T_J=25^{\circ}C$		3	6	mA
Quiescent Current Change	$\Delta I_Q$	$I_{OUT}=5mA\sim 1A$		0.05	0.5	mA
		$V_{IN}=-27V\sim-38V$		0.1	1.0	mA
Output Noise Voltage	eN	$f=10Hz\sim 100kHz$ $T_a=25^{\circ}C$		400		$\mu V$
Output Voltage Drift	$\Delta V_{OUT}/\Delta T$	$I_{OUT}=5mA$		-1		$mV/^{\circ}C$
Ripple Rejection	RR	$V_{IN}=-28V\sim-38V, f=120Hz$	54	60		dB
Peak Current	$I_{PEAK}$	$T_J=25^{\circ}C$		2.2		A

■ APPLICATION CIRCUITS

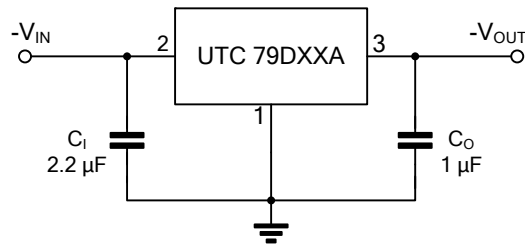

Fig.1 Fixed output regulator

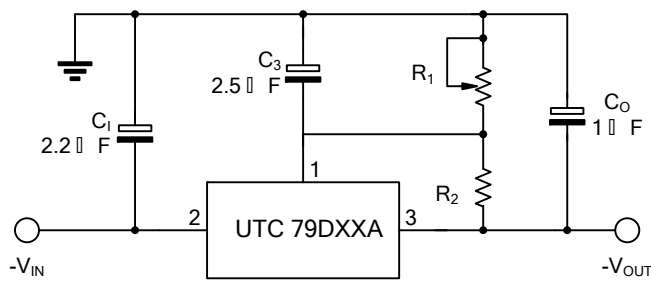
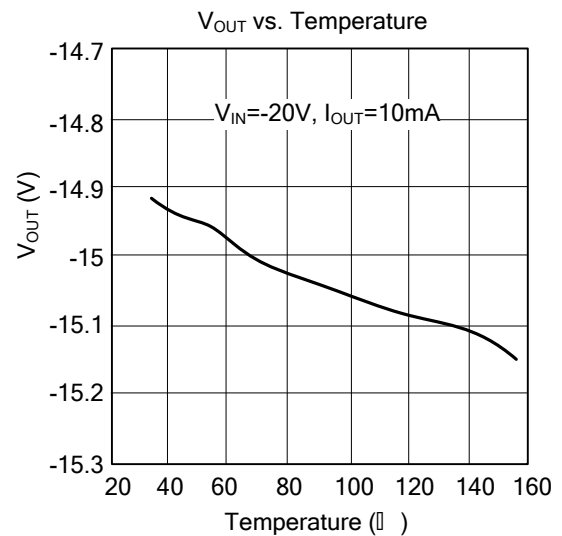
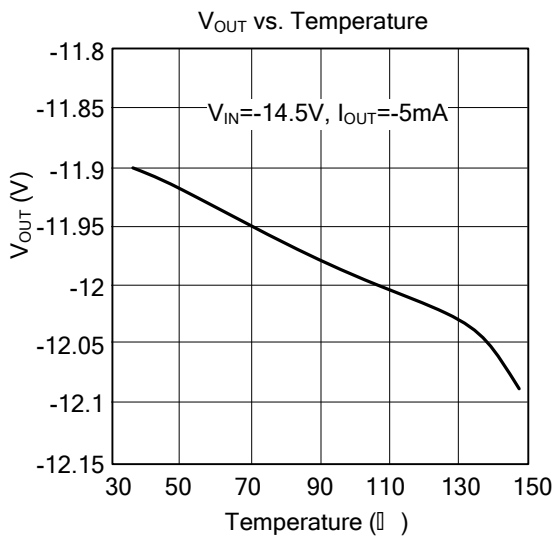
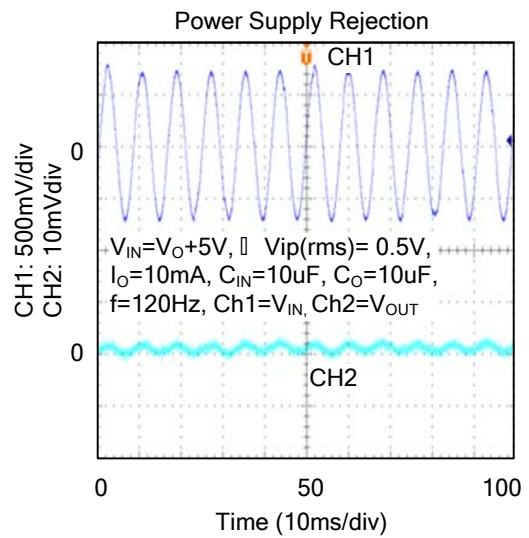
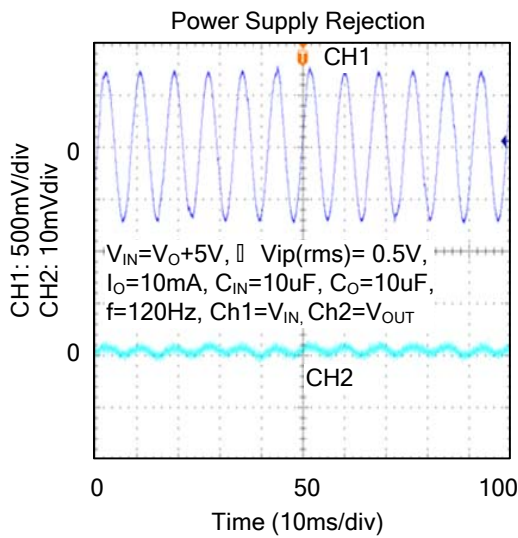
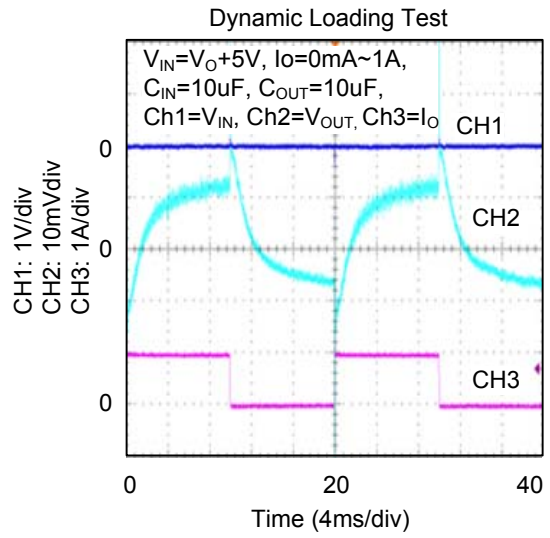
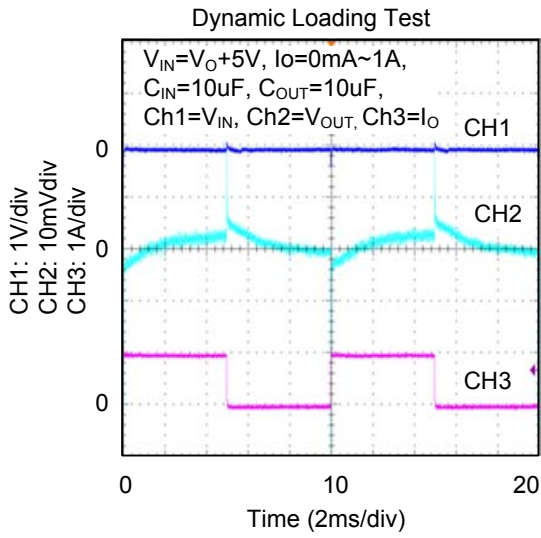

Fig.2 Circuit for increasing output voltage

## ■ TYPICAL CHARACTERISTICS





## ■ TYPICAL CHARACTERISTICS

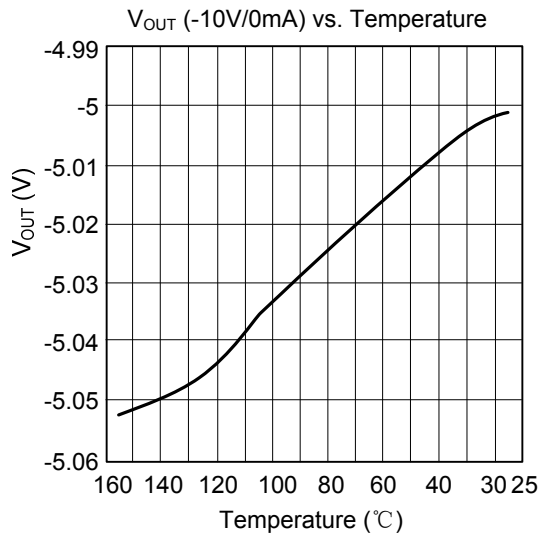

UTC assumes no responsibility for equipment failures that result from using products at values that exceed, even momentarily, rated values (such as maximum ratings, operating condition ranges, or other parameters) listed in products specifications of any and all UTC products described or contained herein. UTC products are not designed for use in life support appliances, devices or systems where malfunction of these products can be reasonably expected to result in personal injury. Reproduction in whole or in part is prohibited without the prior written consent of the copyright owner. The information presented in this document does not form part of any quotation or contract, is believed to be accurate and reliable and may be changed without notice.