

SR220 THRU SR2200

2.0A Axial Leaded Schottky Barrier Rectifiers-20V-200V

Features

- Metal silicon junction ,majority carrier conduction
- Guard ring for overvoltage protection
- Low power loss ,high efficiency
- High current capability ,Low forward voltage drop
- High surge capability
- For use in low voltage ,high frequency inverters, free wheeling ,and polarity protection applications
- High temperature soldering guaranteed:260°C/10 seconds at terminals
- Lead-free parts meet environmental standards of MIL-STD-19500 /228

Mechanical data

- Epoxy : UL94-V0 rated flame retardant
- Case : Molded plastic, DO-15
- Lead : Axial leads, solderable per MIL-STD-202, Method 208 guaranteed
- Polarity: Color band denotes cathode end
- Mounting Position : Any
- Weight : Approximated 0.40 gram

Package outline

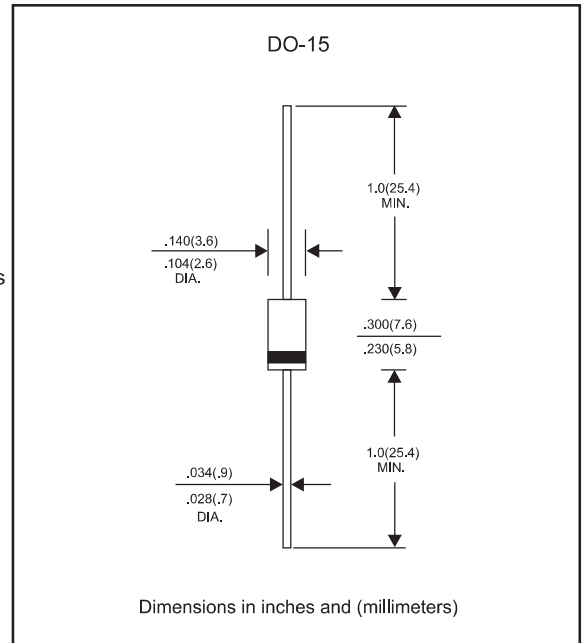

Maximum ratings and Electrical Characteristics (AT T_A=25°C unless otherwise noted)

PARAMETER	CONDITIONS	Symbol	MIN.	TYP.	MAX.	UNIT
Forward rectified current	See Fig.1	I _O			2.0	A
Forward surge current	8.3ms single half sine-wave superimposed on rate load (JEDEC methode)	I _{FSM}			50	A
Reverse current	V _R = V _{RRM} T _J = 25°C	I _R			0.5	mA
	V _R = V _{RRM} T _J = 100°C				10	
Thermal resistance	Junction to ambient Note 1	R _{θJA}		35		°C/W
Diode junction capacitance	f=1MHz and applied 4V DC reverse voltage	C _J		170		pF
Storage temperature		T _{STG}	-65		+175	°C

Note 1: Thermal resistance from junction to lead, and/or to ambient P. C. B. mounted with 0.375" (9.5mm) lead length with 1.5 X1.5"(38X38mm)copper pads

SYMBOLS	V _{RRM} ^{*1} (V)	V _{RMS} ^{*2} (V)	V _R ^{*3} (V)	V _F ^{*4} (V)	Operating temperature T _J , (°C)
SR220	20	14	20	0.55	-55 to +125
SR230	30	21	30		
SR240	40	28	40		
SR250	50	35	50	0.70	-55 to +150
SR260	60	42	60		
SR280	80	56	80	0.85	
SR2100	100	70	100		
SR2150	150	105	150	0.90	
SR2200	200	140	200	0.95	

*1 Repetitive peak reverse voltage

*2 RMS voltage

*3 Continuous reverse voltage

*4 Maximum forward voltage@I_F=2.0A

Rating and characteristic curves (SR220 THRU SR2200)

FIG.1-TYPICAL FORWARD CURRENT DERATING CURVE

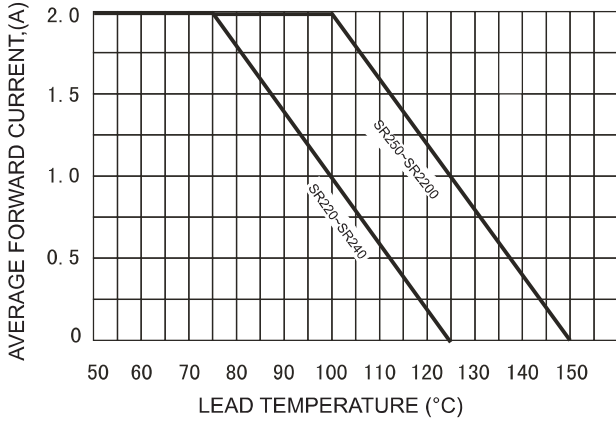

FIG.2-TYPICAL FORWARD CHARACTERISTICS

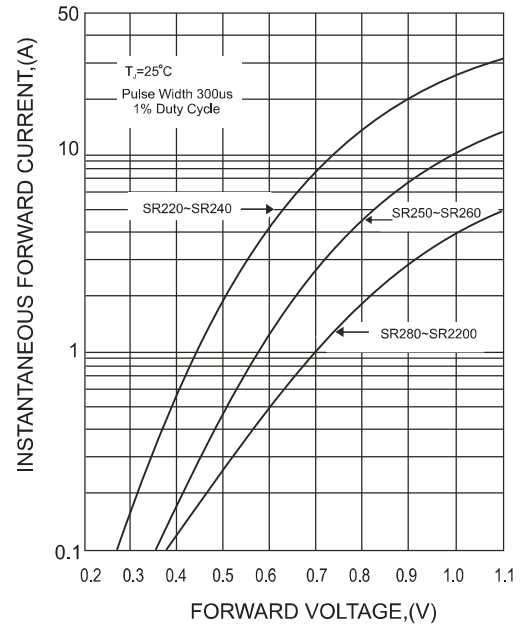

FIG.3-MAXIMUM NON-REPETITIVE FORWARD SURGE CURRENT

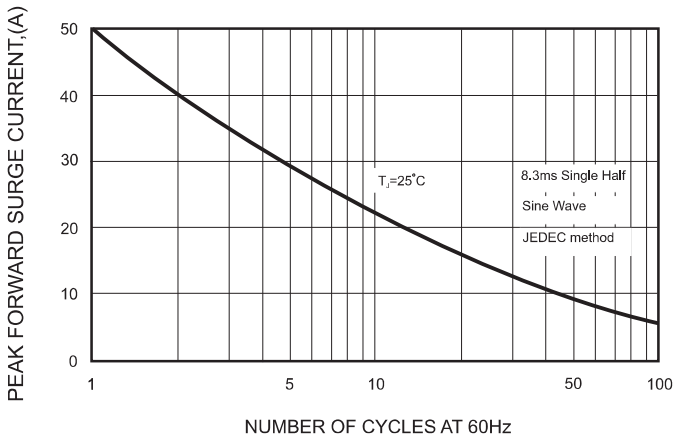

FIG.5 - TYPICAL REVERSE CHARACTERISTICS

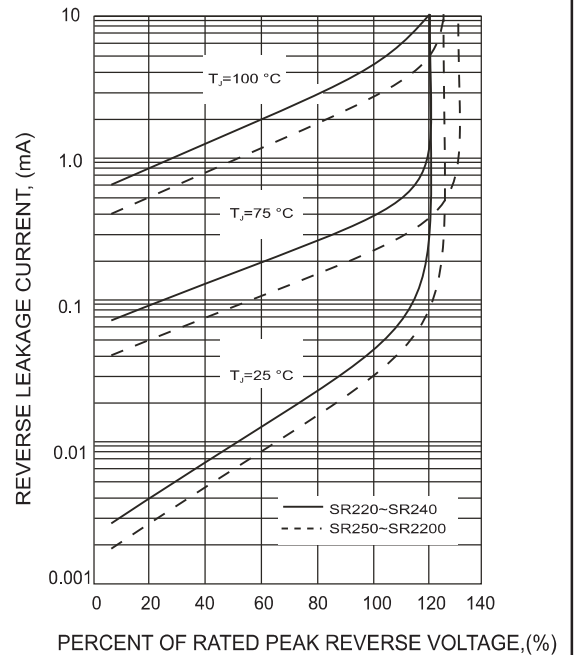
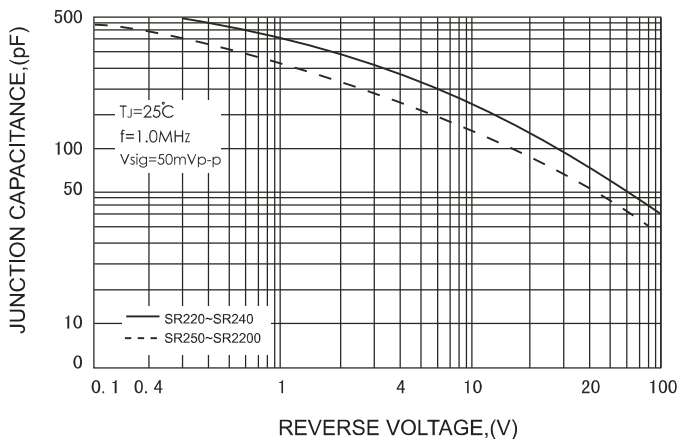



FIG.4-TYPICAL JUNCTION CAPACITANCE



SR220 THRU SR2200

Pinning information

Pin	Simplified outline	Symbol
Pin1 cathode Pin2 anode		

Marking

Type number	Marking code
SR220	SR220
SR230	SR230
SR240	SR240
SR250	SR250
SR260	SR260
SR280	SR280
SR2100	SR2100
SR2150	SR2150
SR2200	SR2200

Taping & bulk specifications for AXIAL devices

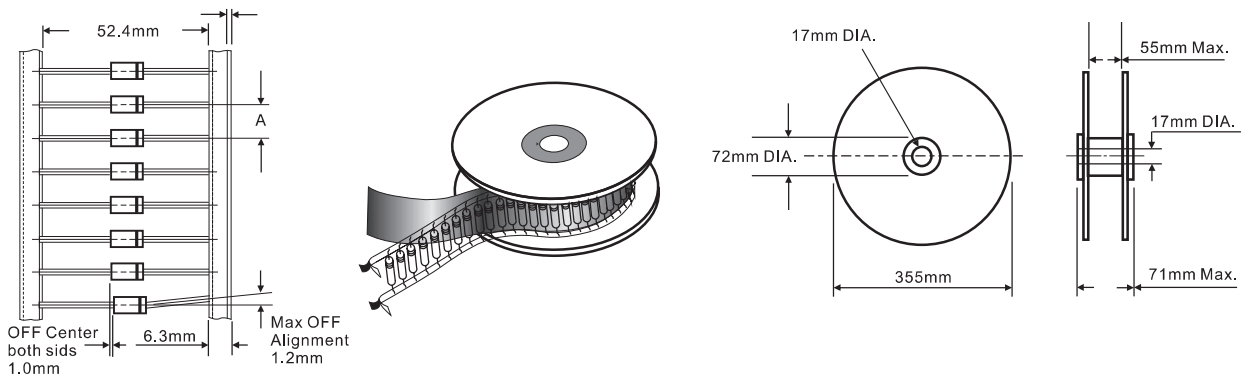

AMMO PACKING

DEVICE CASE TYPE	Q'TY 1 (PCS / BOX)	INNER BOX SIZE (m/m)	CARTON SIZE (m/m)	Q'TY 2 (PCS / CARTON)	APPROX. CROSS WEIGHT(kg)
DO-15	3,000	260 * 83 * 160	440 * 270 * 340	30,000	14.3