

SMCJ Series

List

List.....	1
Package outline.....	2
Features.....	2
Mechanical data.....	2
Maximum ratings	2
Electrical characteristics.....	3~4
Rating and characteristic curves.....	4~5
Pinning information.....	6
Suggested solder pad layout.....	6
Packing information.....	7
Reel packing.....	8
Suggested thermal profiles for soldering processes.....	8
High reliability test capabilities.....	9

SMCJ Series

1500W Surface Mount Transient Voltage Suppressors - 5.0V-440V

Features

- 1500W peak pulse power capability with a 10/1000 us waveform, repetition rate (duty cycle): 0.01%.
- Excellent clamping capability.
- Low incremental surge resistance.
- Fast response time from 0V to VBR, typically less than 1 ps for uni-directional & 5 ns for bi-directional types.
- Glass passivated chip junction.
- Lead-free parts meet RoHS requirements.
- Suffix "-H" indicates Halogen-free parts, ex. SMCJ5.0A-H.

Mechanical data

- Epoxy:UL94-V0 rated flame retardant
- Case : Molded plastic, DO-214AB / SMC-F
- Terminals : Solder plated, solderable per MIL-STD-750, Method 2026
- Polarity : Indicated by cathode band
- Mounting Position : Any
- Weight : Approximated 0.23 gram

Package outline

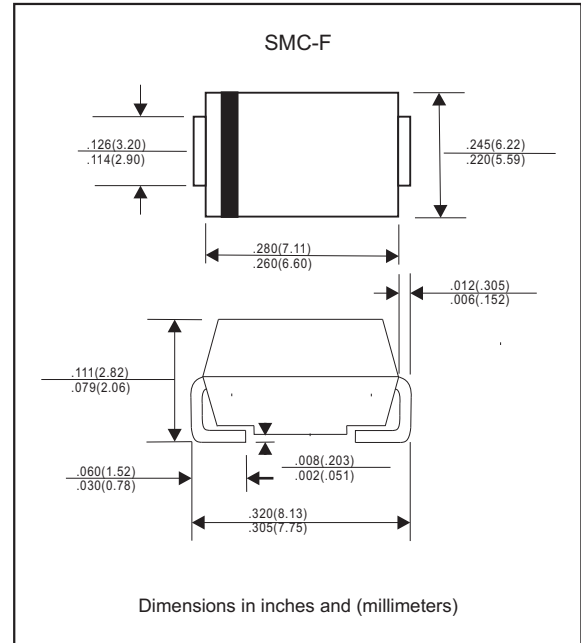

Maximum ratings (AT $T_A=25^{\circ}\text{C}$ unless otherwise noted)

PARAMETER	CONDITIONS	Symbol	Value	UNIT
Peak Power Dissipation	with a 10/1000 us waveform, Note 1, 2 & Fig. 1	P_{PPM}	1500	W
Peak Pulse current	with a 10/1000 us waveform	I_{PPM}	See Table	A
Steady State Power Dissipation	at $T_L=75^{\circ}\text{C}$, Note 2	$P_{M(AV)}$	6.5	W
Peak Forward Surge Current	8.3ms Single Half Sine-Wave, Note 3	I_{FSM}	200	A
Maximum Instantaneous Forward Voltage	at 100A For Uni-Directional Types Only Note 4	V_F	3.5/5.0	V
Operating junction temperature range		T_J	-55 to +150	$^{\circ}\text{C}$
Storage temperature range		T_{STG}	-55 to +150	$^{\circ}\text{C}$

Note 1. Non-repetitive current pulse, per Fig. 3 and derated above $T_A=25^{\circ}\text{C}$ per Fig. 2

2. Mounted on copper pad area of 0.31 x 0.31" (8.0 x 8.0 mm) per Fig 5

3. Measured on 8.3 ms single half sine-wave or equivalent square wave, duty cycle=4 pulses per minute maximum

4. $V_F < 3.5\text{V}$ for $V_{BR} < 200\text{V}$ and $V_F < 5.0\text{V}$ for $V_{BR} > 201\text{V}$

SMCJ Series

Electrical characteristics (at $T_A=25^\circ\text{C}$ unless otherwise noted)

Part No. (UNI)	Part No. (BI)	Reverse Stand-off Voltage	Breakdown Voltage @ I_T		Test Current	Maximum Clamping Voltage @ I_{PP}		Maximum Reverse Leakage Current	Marking Code	
		V_{RWM}	$V_{BR\ Min}$	$V_{BR\ Max}$	I_T	V_c	I_{PP}	$I_R@V_{RWM}$		
		Volts	Volts	Volts	mA	Volts	A	μA	UNI	BI
SMCJ5.0A	SMCJ5.0CA	5.0	6.40	7.00	10	9.2	163.0	800	GDE	BDE
SMCJ6.0A	SMCJ6.0CA	6.0	6.67	7.37	10	10.3	145.6	800	GDG	BDG
SMCJ6.5A	SMCJ6.5CA	6.5	7.22	7.98	10	11.2	133.9	500	GDK	BDK
SMCJ7.0A	SMCJ7.0CA	7.0	7.78	8.60	10	12.0	125.0	200	GDM	BDM
SMCJ7.5A	SMCJ7.5CA	7.5	8.33	9.21	1.0	12.9	116.3	100	GDP	BDP
SMCJ8.0A	SMCJ8.0CA	8.0	8.89	9.83	1.0	13.6	110.3	50	GDR	BDR
SMCJ8.5A	SMCJ8.5CA	8.5	9.44	10.4	1.0	14.4	104.2	20	GDT	BDT
SMCJ9.0A	SMCJ9.0CA	9.0	10.0	11.1	1.0	15.4	97.4	10	GDV	BDV
SMCJ10A	SMCJ10CA	10	11.1	12.3	1.0	17.0	88.2	5	GDX	BDX
SMCJ11A	SMCJ11CA	11	12.2	13.5	1.0	18.2	82.4	5	GDZ	BDZ
SMCJ12A	SMCJ12CA	12	13.3	14.7	1.0	19.9	75.3	5	GEE	BEE
SMCJ13A	SMCJ13CA	13	14.4	15.9	1.0	21.5	69.7	5	GEG	BEG
SMCJ14A	SMCJ14CA	14	15.6	17.2	1.0	23.2	64.7	5	GEK	BEK
SMCJ15A	SMCJ15CA	15	16.7	18.5	1.0	24.4	61.5	5	GEM	BEM
SMCJ16A	SMCJ16CA	16	17.8	19.7	1.0	26.0	57.7	5	GEP	BEP
SMCJ17A	SMCJ17CA	17	18.9	20.9	1.0	27.6	54.4	5	GER	BER
SMCJ18A	SMCJ18CA	18	20.0	22.1	1.0	29.2	51.4	5	GET	BET
SMCJ20A	SMCJ20CA	20	22.2	24.5	1.0	32.4	46.3	5	GEV	BEV
SMCJ22A	SMCJ22CA	22	24.4	26.9	1.0	35.5	42.2	5	GEX	BEX
SMCJ24A	SMCJ24CA	24	26.7	29.5	1.0	38.9	38.6	5	GEZ	BEZ
SMCJ26A	SMCJ26CA	26	28.9	31.9	1.0	42.1	35.6	5	GFE	BFE
SMCJ28A	SMCJ28CA	28	31.1	34.4	1.0	45.4	33.0	5	GFG	BFG
SMCJ30A	SMCJ30CA	30	33.3	36.8	1.0	48.4	31.0	5	GFK	BFK
SMCJ33A	SMCJ33CA	33	36.7	40.6	1.0	53.3	28.1	5	GFM	BFM
SMCJ36A	SMCJ36CA	36	40.0	44.2	1.0	58.1	25.8	5	GFP	BFP
SMCJ40A	SMCJ40CA	40	44.4	49.1	1.0	64.5	23.2	5	GFR	BFR
SMCJ43A	SMCJ43CA	43	47.8	52.8	1.0	69.4	21.6	5	GFT	BFT
SMCJ45A	SMCJ45CA	45	50.0	55.3	1.0	72.7	20.6	5	GFV	BFV
SMCJ48A	SMCJ48CA	48	53.3	58.9	1.0	77.4	19.4	5	GFX	BFX
SMCJ51A	SMCJ51CA	51	56.7	62.7	1.0	82.4	18.2	5	GFZ	BFZ
SMCJ54A	SMCJ54CA	54	60.0	66.3	1.0	87.1	17.2	5	GGE	BGE
SMCJ58A	SMCJ58CA	58	64.4	71.2	1.0	93.6	16.0	5	GGG	BGG
SMCJ60A	SMCJ60CA	60	66.7	73.7	1.0	96.8	15.5	5	GGK	BGK
SMCJ64A	SMCJ64CA	64	71.1	78.6	1.0	103.0	14.5	5	GGM	BGM
SMCJ70A	SMCJ70CA	70	77.8	86.0	1.0	113.0	13.2	5	GGP	BGP
SMCJ75A	SMCJ75CA	75	83.3	92.1	1.0	121.0	12.4	5	GGR	BGR
SMCJ78A	SMCJ78CA	78	86.7	95.8	1.0	126.0	11.9	5	GGT	BGT
SMCJ85A	SMCJ85CA	85	94.4	104	1.0	137.0	10.9	5	GGV	BGV

SMCJ Series

Electrical characteristics (at $T_A=25^\circ\text{C}$ unless otherwise noted)

Part No. (UNI)	Part No. (BI)	Reverse Stand-off Voltage	Breakdown Voltage @ I_T		Test Current	Maximum Clamping Voltage @ I_{PP}		Maximum Reverse Leakage Current	Marking Code	
		V_{RWM}	$V_{BR Min}$	$V_{BR Max}$	I_T	V_C	I_{PP}	$I_R@V_{RWM}$		
		Volts	Volts	Volts	mA	Volts	A	μA	UNI	BI
SMCJ90A	SMCJ90CA	90	100	111	1.0	146.0	10.2	5	GGX	BGX
SMCJ100A	SMCJ100CA	100	111	123	1.0	162.0	9.3	5	GGZ	BGZ
SMCJ110A	SMCJ110CA	110	122	135	1.0	177.0	8.4	5	GHE	BHE
SMCJ120A	SMCJ120CA	120	133	147	1.0	193.0	7.7	5	GHG	BHG
SMCJ130A	SMCJ130CA	130	144	159	1.0	209.0	7.1	5	GHK	BHK
SMCJ150A	SMCJ150CA	150	167	185	1.0	243.0	6.2	5	GHM	BHM
SMCJ160A	SMCJ160CA	160	178	197	1.0	259.0	5.7	5	GHP	BHP
SMCJ170A	SMCJ170CA	170	189	209	1.0	275.0	5.4	5	GHR	BHR
SMCJ180A	SMCJ180CA	180	201	222	1.0	292.0	5.1	5	GHT	BHT
SMCJ200A	SMCJ200CA	200	224	247	1.0	324.0	4.6	5	GHW,GHV	BHW,BHV
SMCJ220A	SMCJ220CA	220	246	272	1.0	356.0	4.2	5	GHX	BHX
SMCJ250A	SMCJ250CA	250	279	309	1.0	405.0	3.7	5	GHZ	BHZ
SMCJ300A	SMCJ300CA	300	335	371	1.0	486.0	3.0	5	GJE	BJE
SMCJ350A	SMCJ350CA	350	391	432	1.0	567.0	2.6	5	GJG	BJG
SMCJ400A	SMCJ400CA	400	447	494	1.0	648.0	2.3	5	GJK	BJK
SMCJ440A	SMCJ440CA	440	492	543	1.0	713.0	2.1	5	GJM	BJM

- Note 1. V_{BR} measured after I_T applied for 300us, I_T =square wave pulse or equivalent
 2. Surge current waveform per Fig. 3 and derated per Fig. 2
 3. For bi-directional types having V_{RWM} of 10 volts and less, the I_R limit is doubled
 4. Suffix 'C' denotes bi-directional devices, Suffix 'A' denotes 5% tolerance devices, no suffix denotes 10% tolerance devices.
 5. All terms and symbols are consistent with ANS/IEEE C62.35
 6. Transient Voltage Suppressors (TVS) are devices used to protect vulnerable circuits from electrical overstress such as that caused by electrostatic discharge, inductive load switching and induced lightning. Within the TVS, damaging voltage spikes are limited by clamping or avalanche action of a rugged silicon pn junction which reduces the amplitude of the transient to a nondestructive level. See Fig. 7 & Fig. 8

Rating and characteristic curves (SMCJ SERIES)

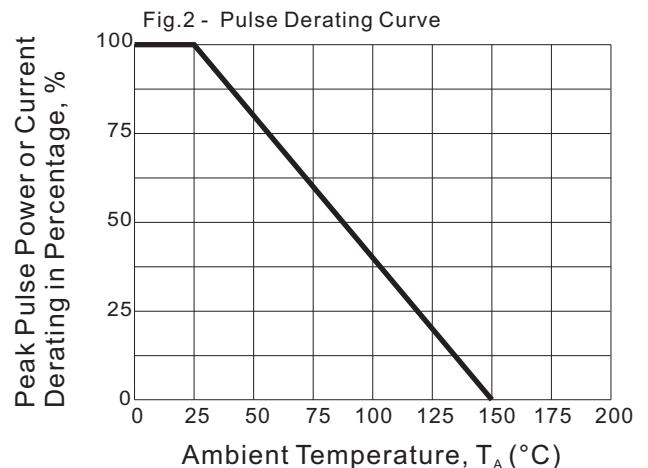
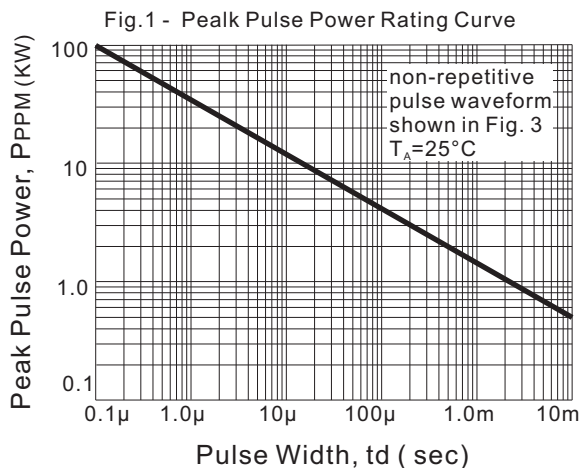

Rating and characteristic curves (SMCJ SERIES)

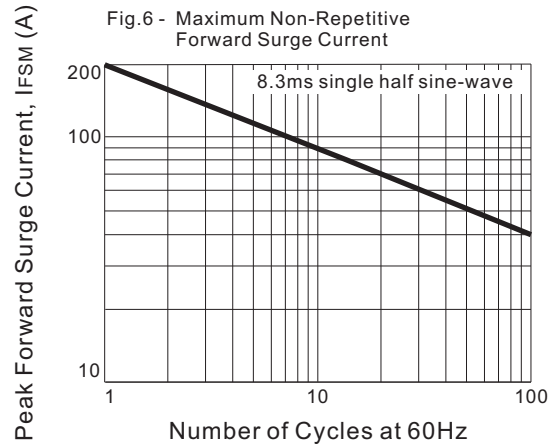
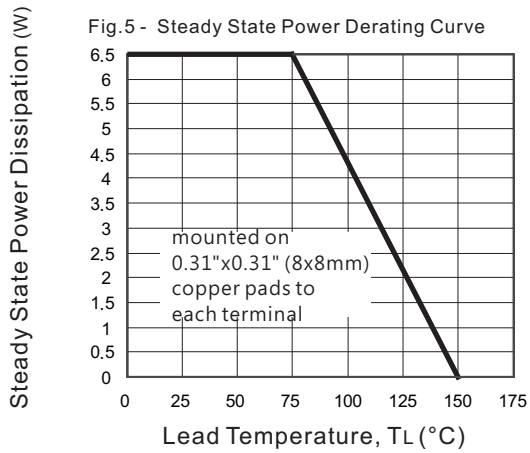
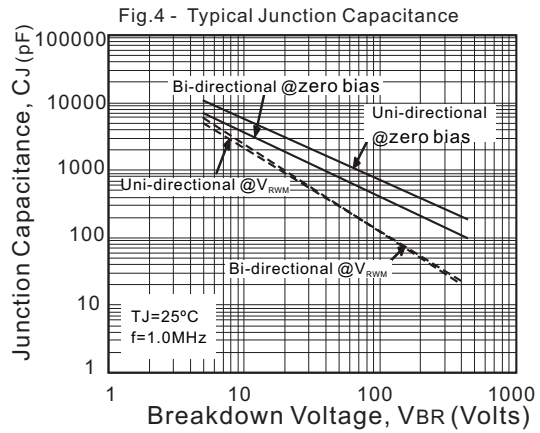
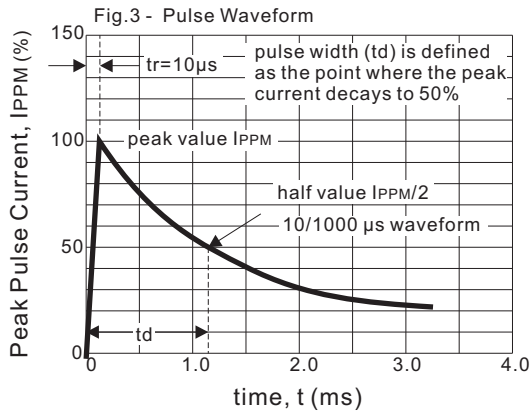

Fig. 7 - Transients of several thousand volts can be clamped to a safe level by the TVS

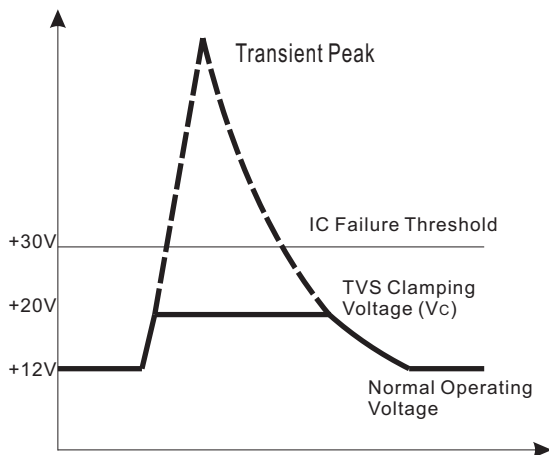
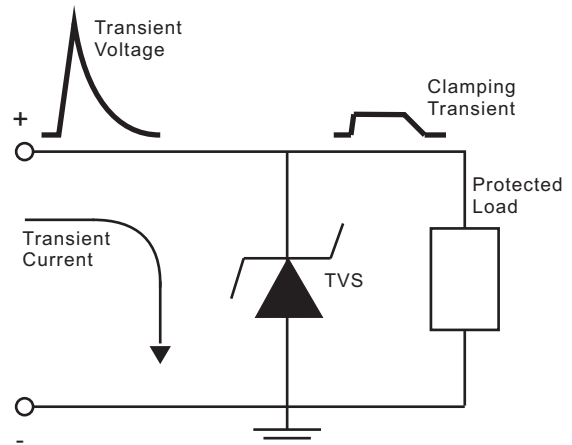

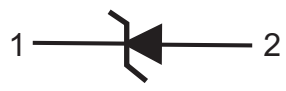



Fig. 8 - Transient current is diverted to ground thru TVS; the voltage seen by the protected load is limited to the clamping voltage level



SMCJ Series

Pinning information

Pin	Simplified outline	Symbol
Uni-Directional Pin1 cathode Pin2 anode		
Bi-Directional		

Suggested solder pad layout

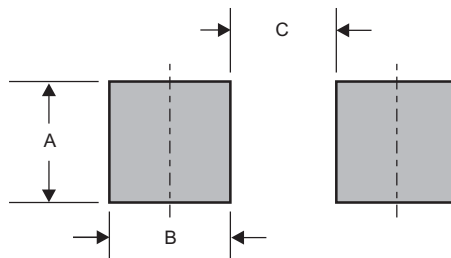

Dimensions in inches and (millimeters)

PACKAGE	A	B	C
SMC-F	0.132 (3.30)	0.100 (2.50)	0.176(4.40)

SMCJ Series

Packing information

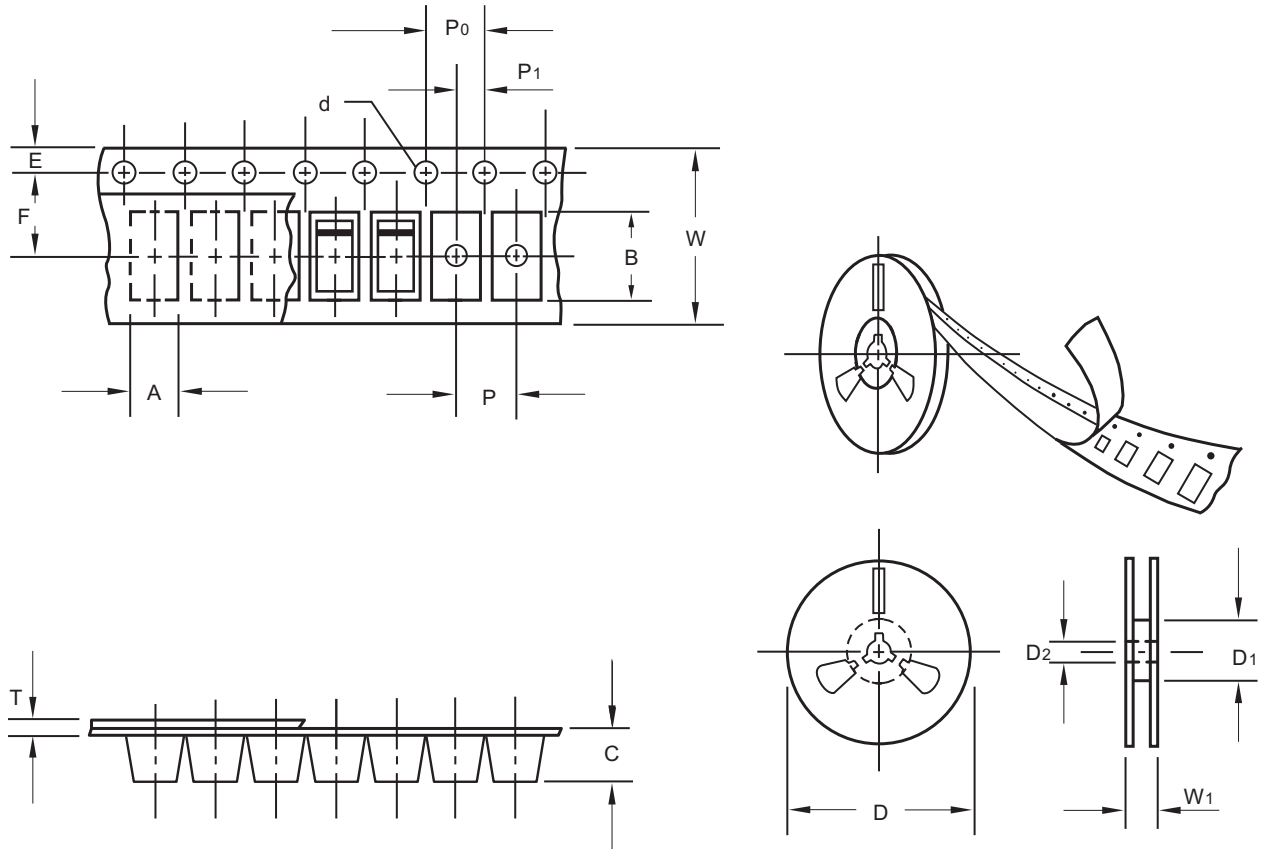

unit:mm

Item	Symbol	Tolerance	SMC-F
Carrier width	A	0.15	6.00
Carrier length	B	0.2	8.25
Carrier depth	C	0.1	2.36
Sprocket hole	d	0.1	1.50
13" Reel outside diameter	D	2.0	330.00
13" Reel inner diameter	D1	min	50.00
7" Reel outside diameter	D	2.0	178.00
7" Reel inner diameter	D1	min	62.00
Feed hole diameter	D2	0.5	13.00
Sprocket hole position	E	0.1	1.75
Punch hole position	F	0.1	7.50
Punch hole pitch	P	0.1	8.00
Sprocket hole pitch	P0	0.1	4.00
Embossment center	P1	0.1	2.00
Overall tape thickness	T	0.1	0.23
Tape width	W	0.3	16.00
Reel width	W1	1.0	18.00

Note: Devices are packed in accordance with EIA standard RS-481-A and specifications listed above.

SMCJ Series

Reel packing

PACKAGE	REEL SIZE	REEL (pcs)	COMPONENT SPACING (m/m)	BOX (pcs)	INNER BOX (m/m)	REEL DIA, (m/m)	CARTON SIZE (m/m)	CARTON (pcs)	APPROX. GROSS WEIGHT (kg)
SMC-F	7"	500	8.0	5,000	183*155*183	178	382*356*392	40,000	18.00
	13"	3,000	8.0	6,000	337*337*37	330	350*330*360	48,000	18.00

Suggested thermal profiles for soldering processes

- 1.Storage environment: Temperature=5°C~40°C Humidity=55%±25%
- 2.Reflow soldering of surface-mount devices

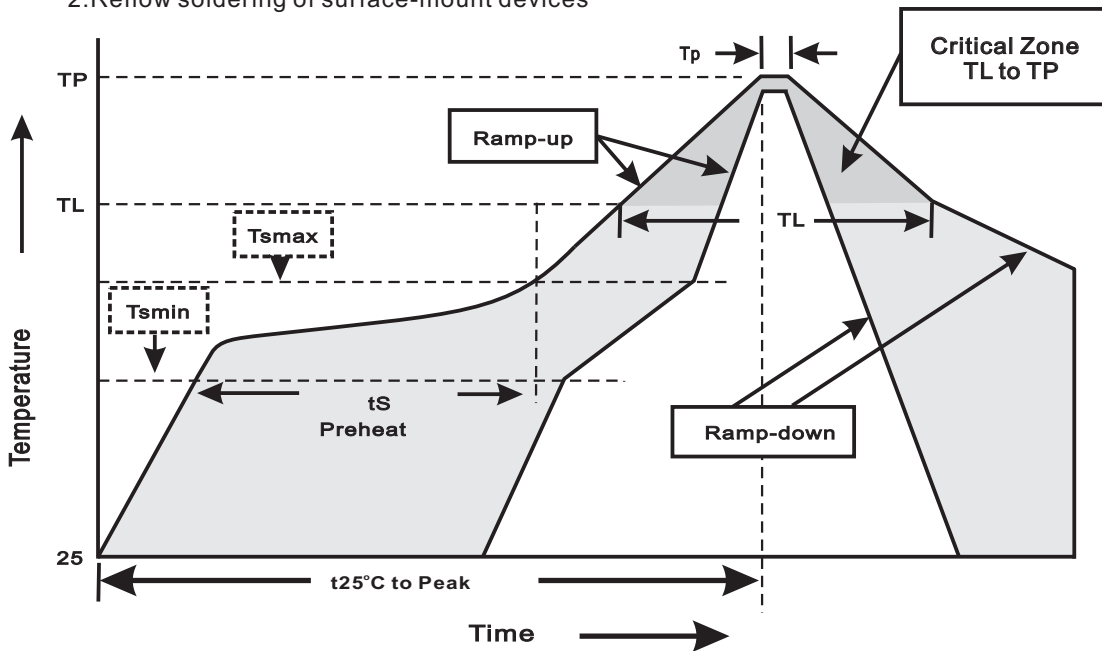

3.Reflow soldering

Profile Feature	Soldering Condition
Average ramp-up rate(TL to TP)	<3°C/sec
Preheat -Temperature Min(Tsmin) -Temperature Max(Tsmax) -Time(min to max)(ts)	150°C 200°C 60~120sec
Tsmax to TL -Ramp-upRate	<3°C/sec
Time maintained above: -Temperature(TL) -Time(tL)	217°C 60~260sec
Peak Temperature(TP)	255°C-0/+5°C
Time within 5°C of actual Peak Temperature(tp)	10~30sec
Ramp-down Rate	<6°C/sec
Time 25°C to Peak Temperature	<6minutes

SMCJ Series

High reliability test capabilities

Item Test	Conditions	Reference
1. Solder Resistance	at $260\pm 5^{\circ}\text{C}$ for $10\pm 2\text{sec.}$ immerse body into solder $1/16''\pm 1/32''$	MIL-STD-750D METHOD-2031
2. Solderability	at $245\pm 5^{\circ}\text{C}$ for 5 sec.	MIL-STD-202F METHOD-208
3. High Temperature Reverse Bias	$V_{\text{RWM}}=80\%$ rate at $T_{\text{J}}=150^{\circ}\text{C}$ for 168 hrs.	MIL-STD-750D METHOD-1038
4. Pressure Cooker	$15P_{\text{SIG}}$ at $T_{\text{A}}=121^{\circ}\text{C}$ for 4 hrs.	JESD22-A102
5. Temperature Cycling	-55°C to $+125^{\circ}\text{C}$ dwelled for 30 min. and transferred for 5min. total 10 cycles.	MIL-STD-750D METHOD-1051
6. Humidity	at $T_{\text{A}}=85^{\circ}\text{C}$, RH=85% for 1000hrs.	MIL-STD-750D METHOD-1021
7. High Temperature Storage Life	at 175°C for 1000 hrs.	MIL-STD-750D METHOD-1031