

## Transient Voltage Suppressors - P6SMB Series

### Features

1. Halogen-free
2. Rohs compliant
3. Typical maximum temperature coefficient
4.  $\Delta V_{BR} = 0.1\% \times V_{BR@25^\circ\text{C}} \times \Delta T$
5. Glass passivated Chip junction in DO-214AA package
6. 600W peak pulse capability at 10x1000μs waveform, repetition rate(duty cycles):0.01%
7. Fast response time:typically less than 1.0ps from 0 Volts to BV min
8. Excellent clamping capability
9. Low incremental surge resistance
- 10 Typical IR less than 5μA above 12V
11. High temperature soldering guaranteed: 260°C/40 seconds / 0.375",
12. (9.5mm) lead length, 5lbs., (2.3kg) tension
13. Plastic package has underwriters laboratory flammability classification 94v-0

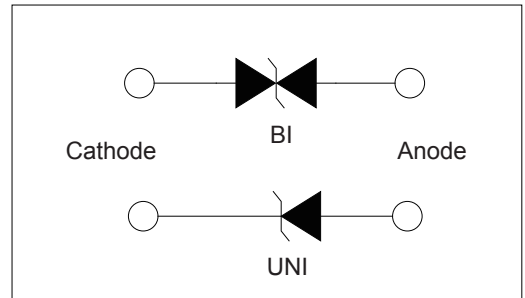
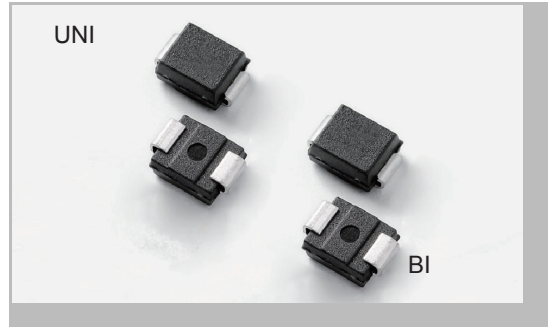

### Applications

TVS devices are ideal for the protection of I/O interfaces,VCC bus and other vulnerable circuits used in telecom, computer, industrial and consumer electronic applications.

### Mechanical Characteristics

Rating	Symbol	Value	Units
Peak Pulse Power Dissipation by 10x1000μs test waveform (Fig.1)(Note 1)	$P_{PPM}$	600	Watts
Steady State Power Dissipation on infinite heat sink at TL=75°C (Fig. 5)	$P_D$	5	Watts
Peak Forward Surge Current, 8.3ms Single Half Sine Wave Unidirectional only (Note 2)	$I_{FSM}$	100	Amps
Maximum Instantaneous Forward Voltage at 25A for Unidirectional only (Note 3)	$V_F$	3.5/5.0	V
Operating junction and Storage Temperature Range.	$T_J, T_{STG}$	-55°C to 150°C	°C
Typical Thermal Resistance Junction to Lead	$R_{\theta JL}$	20	°C/W
Typical Thermal Resistance Junction to Ambient	$R_{\theta JA}$	100	°C/W

#### Notes:

1. Non-repetitive current pulse , per Fig. 3 and derated above TA = 25°C per Fig. 2.
2. Mounted on copper pad area of 0.2x0.2" (5.0 x 5.0mm) to each terminal.
3. Measured on 8.3ms single half sine wave or equivalent square wave for unidirectional device only, duty cycle=4 per minute maximum.
4.  $V_F < 3.5V$  for  $V_{BR} < 200V$  and  $V_F < 5.0V$  for  $V_{BR} > 201V$ .

# Transient Voltage Suppressors - P6SMB Series

## Electrical Characteristics

Type Number		Reverse Stand-Off Voltage	Breakdown Voltage@I <sub>T</sub>		Test Current	Maximum Clamping Voltage@I <sub>PP</sub>	Peak Pulse Current	Reverse Leakage @V <sub>RWM</sub>
(UNI)	(BI)	V <sub>RWM</sub> (V)	V <sub>BR</sub> MIN.(V)	V <sub>BR</sub> MAX.(V)	I <sub>T</sub> (mA)	V <sub>C</sub> (V)	I <sub>PP</sub> (A)	IR(μA)
P6SMB6.8A	P6SMB6.8CA	5.80	6.40	7.25	10	9.2	65.2	800
P6SMB7.5A	P6SMB7.5CA	6.40	7.22	8.30	10	10.3	58.3	800
P6SMB8.2A	P6SMB8.2CA	7.02	7.78	8.95	10	12.0	50.0	200
P6SMB9.1A	P6SMB9.1CA	7.78	8.33	9.58	1	12.9	46.6	100
P6SMB10A	P6SMB10CA	8.55	9.44	10.82	1	13.6	44.1	50
P6SMB11A	P6SMB11CA	9.40	10.00	11.50	1	18.2	33.0	5
P6SMB12A	P6SMB12CA	10.20	11.10	12.80	1	19.9	30.2	5
P6SMB13A	P6SMB13CA	11.10	12.20	14.00	1	21.5	27.9	5
P6SMB15A	P6SMB15CA	12.80	14.40	16.50	1	24.4	24.6	5
P6SMB16A	P6SMB16CA	13.60	15.60	17.90	1	26.0	23.1	5
P6SMB18A	P6SMB18CA	15.30	16.70	19.20	1	29.2	20.5	5
P6SMB20A	P6SMB20CA	17.10	18.90	21.70	1	32.4	18.5	5
P6SMB22A	P6SMB22CA	18.80	20.00	23.30	1	35.5	16.9	5
P6SMB24A	P6SMB24CA	20.50	22.20	25.50	1	38.9	15.2	5
P6SMB27A	P6SMB27CA	23.10	24.40	28.00	1	42.1	14.2	5
P6SMB30A	P6SMB30CA	25.60	28.90	33.20	1	48.4	12.4	5
P6SMB33A	P6SMB33CA	28.20	31.10	35.80	1	53.3	11.3	5
P6SMB36A	P6SMB36CA	20.80	33.30	38.30	1	58.1	10.3	5
P6SMB39A	P6SMB39CA	33.30	36.70	42.20	1	64.5	9.3	5
P6SMB43A	P6SMB43CA	36.80	40.00	46.00	1	69.4	8.6	5
P6SMB47A	P6SMB47CA	40.20	44.40	51.10	1	72.7	8.3	5
P6SMB51A	P6SMB51CA	43.60	47.80	54.90	1	82.4	7.3	5
P6SMB56A	P6SMB56CA	47.80	50.00	57.50	1	87.1	6.9	5
P6SMB62A	P6SMB62CA	53.00	56.70	65.20	1	96.8	6.2	5
P6SMB68A	P6SMB68CA	58.10	64.40	74.10	1	103.0	5.8	5
P6SMB75A	P6SMB75CA	64.10	71.10	81.80	1	121.0	4.9	5
P6SMB82A	P6SMB82CA	70.10	77.80	89.50	1	137.0	4.4	5
P6SMB91A	P6SMB91CA	77.80	86.70	99.70	1	146.0	4.1	5
P6SMB100A	P6SMB100CA	85.50	94.40	108.20	1	162.0	3.7	5
P6SMB110A	P6SMB110CA	94.00	100.00	115.50	1	177.0	3.4	5
P6SMB120A	P6SMB120CA	102.00	111.00	128.00	1	193.0	3.1	5
P6SMB130A	P6SMB130CA	111.00	122.00	140.50	1	209.0	2.9	5
P6SMB150A	P6SMB150CA	128.00	144.00	165.50	1	243.0	2.5	5
P6SMB180A	P6SMB180CA	154.00	167.00	192.60	1	292.0	2.1	5
P6SMB200A	P6SMB200CA	171.00	189.00	217.50	1	324.0	1.9	5
P6SMB220A	P6SMB220CA	185.00	209.00	243.20	1	356.0	1.7	5
P6SMB250A	P6SMB250CA	214.00	231.00	268.80	1	405.0	1.5	5

# Transient Voltage Suppressors - P6SMB Series

## Ratings and Characteristic Curves

Figure 1 - Peak Pulse Power Rating

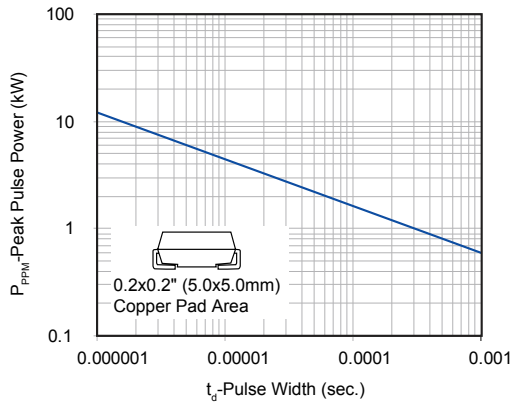

Figure 2 - Pulse Derating Curve

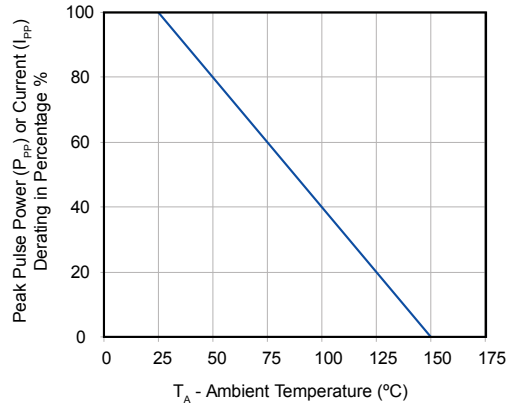

Figure 3 - Pulse Waveform

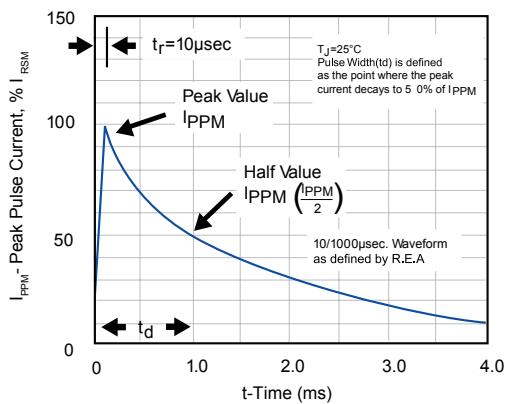

Figure 4 - Typical Junction Capacitance

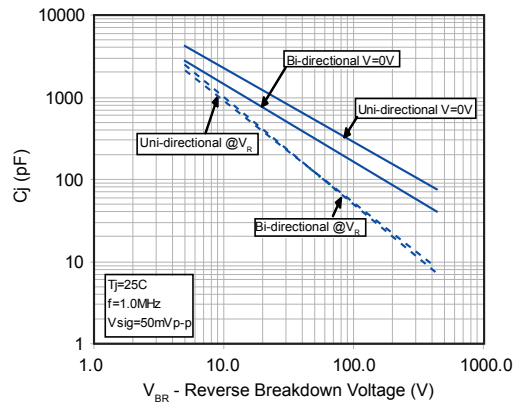

Figure 5 - Steady State Power Derating Curve

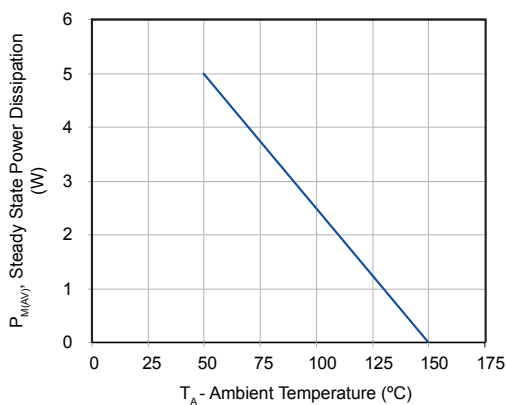
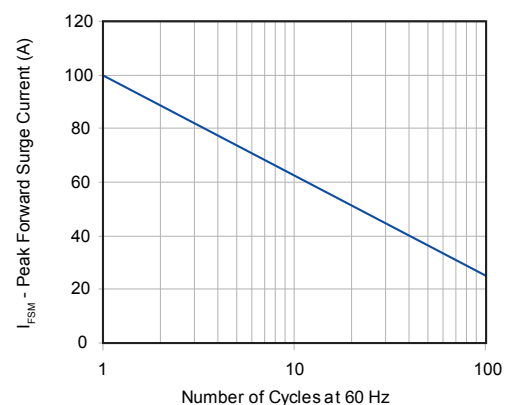

Figure 6 - Maximum Non-Repetitive Peak Forward Surge Current Uni-Directional Only



# Transient Voltage Suppressors - P6SMB Series

## Soldering Parameters

	Flow Condition	Lead-free assembly
Pre Heat	- Temperature Min ( $T_{s(min)}$ )	150°C
	- Temperature Max ( $T_{s(max)}$ )	200°C
	- Time (min to max) ( $t_s$ )	60-180 secs
Average ramp up rate (Liquidus Temp ( $T_L$ ) to peak)		3°C/second max
$T_{s(max)}$ to $T_L$ - Ramp-up Rate		3°C/second max
Reflow	- Temperature ( $T_L$ ) (Liquidus)	217°C
	- Time (min to max) ( $t_s$ )	60-150 seconds
Peak Temperature ( $T_p$ )		260 <sup>+0/-5</sup> °C
Time within 5°C of actual peak Temperature ( $t_p$ )		20-40 seconds
Ramp-down Rate		6°C/second max
Time 25°C to peak Temperature ( $T_p$ )		8 minutes Max.
Do not exceed		280°C

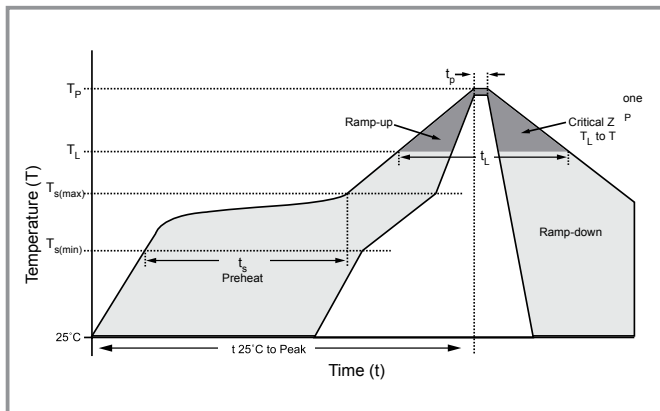

## Physical Specifications

Weight	0.003 ounce, 0.093 grams
Case	JEDEC DO214AA. Molded plastic body over glass passivated junction
Polarity	Color band denotes cathode except Bidirectional.
Termination	Matte Tin-plated leads, Solderable per JESD22-B102D

## Environmental Specifications

Temperature Cycle	JESD22-A104
Pressure Cooker	JESD 22-A102
High Temp. Storage	JESD22-A103
HTRB	JESD22-A108
Thermal Shock	JESD22-A106

# Transient Voltage Suppressors - P6SMB Series

## Dimensions

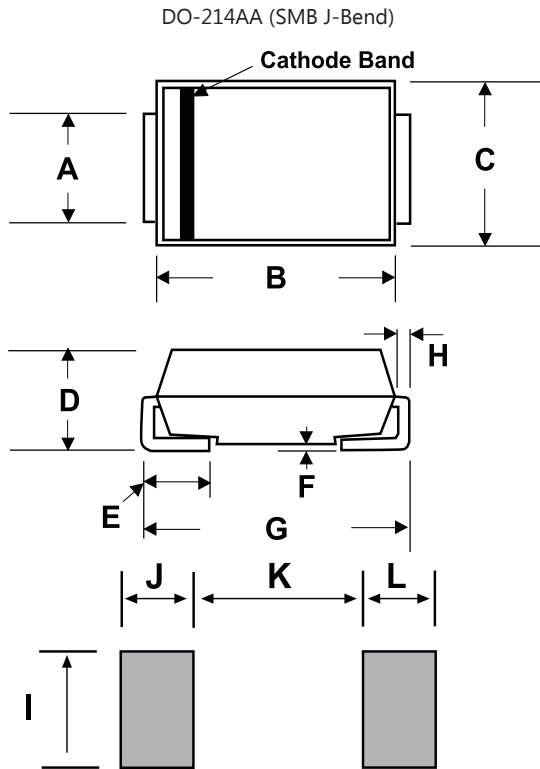

Unit:mm

DIM	Inches		Millimeters	
	Min	Max	Min	Max
A	0.077	0.086	1.950	2.200
B	0.160	0.180	4.060	4.570
C	0.130	0.155	3.300	3.940
D	0.084	0.096	2.130	2.440
E	0.030	0.060	0.760	1.520
F	-	0.008	-	0.203
G	0.205	0.220	5.210	5.590
H	0.006	0.012	0.152	0.305
I	0.089	-	2.260	-
J	0.085	-	2.160	-
K	-	0.107	-	2.740
L	0.085	-	2.160	-

## Part Numbering System

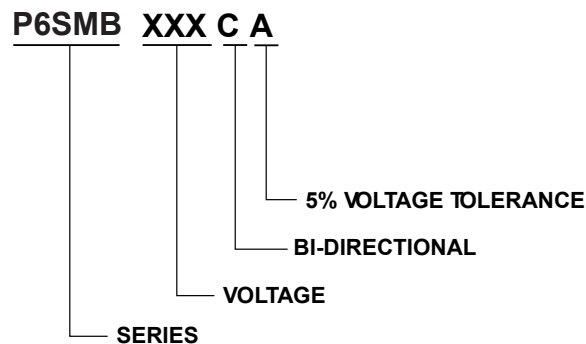

## Warehouse Storage Conditions of Products

- Storage Conditions:
  - Storage Temperature: -10°C~+40°C
  - Relative Humidity: ≤75%RH
  - Keep away from corrosive atmosphere and sunlight.
- Period of Storage: 1 year