

## 200-MHz GENERAL-PURPOSE CLOCK BUFFER, PCI-X COMPLIANT

Check for Samples: [CDCV304](#)

### FEATURES

- General-Purpose and PCI-X 1:4 Clock Buffer
  - Operating Frequency
    - 0 MHz to 200 MHz General-Purpose
  - Low Output Skew: <100 ps
  - Distributes One Clock Input to One Bank of Four Outputs
  - Output Enable Control that Drives Outputs Low when OE is Low
  - Operates from Single 3.3-V Supply or 2.5-V Supply
- PCI-X Compliant
  - 8-Pin TSSOP Package

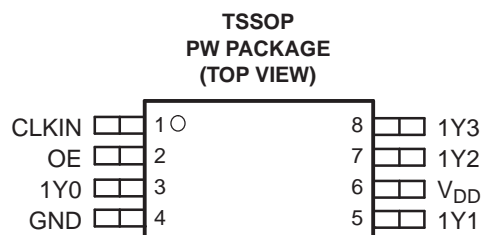

### DESCRIPTION

The CDCV304 is a high-performance, low-skew, general-purpose PCI-X compliant clock buffer. It distributes one input clock signal (CLKIN) to the output clocks (1Y[0:3]). It is specifically designed for use with PCI-X applications. The CDCV304 operates at 3.3 V and 2.5 V and is therefore compliant to the 3.3-V PCI-X specifications.

The CDCV304 is characterized for operation from –40°C to 85°C for automotive and industrial applications.

### FUNCTIONAL BLOCK DIAGRAM

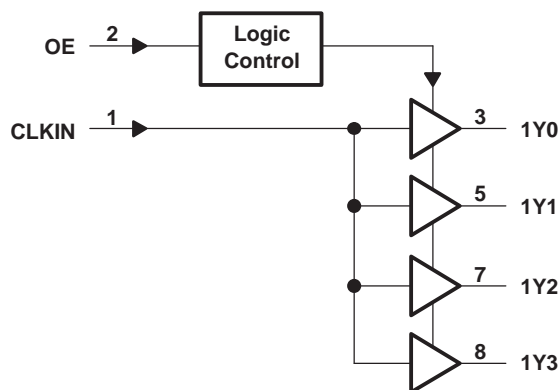

**Table 1. FUNCTION TABLE**

INPUTS		OUTPUTS
CLKIN	OE	1Y[0:3]
L	L	L
H	L	L
L	H	L
H	H	H



Please be aware that an important notice concerning availability, standard warranty, and use in critical applications of Texas Instruments semiconductor products and disclaimers thereto appears at the end of this data sheet.



This integrated circuit can be damaged by ESD. Texas Instruments recommends that all integrated circuits be handled with appropriate precautions. Failure to observe proper handling and installation procedures can cause damage.

ESD damage can range from subtle performance degradation to complete device failure. Precision integrated circuits may be more susceptible to damage because very small parametric changes could cause the device not to meet its published specifications.

### TERMINAL FUNCTIONS

TERMINAL		I/O	DESCRIPTION
NAME	NO.		
1Y[0:3]	3, 5, 7, 8	O	Buffered output clocks
CLKIN	1	I	Input reference frequency
GND	4	Power	Ground
OE	2	I	Output enable control
V <sub>DD</sub>	6	Power	Supply

### THERMAL INFORMATION<sup>(1)</sup>

CDCV304PW 8-PIN TSSOP				THERMAL AIR FLOW (CFM)				UNIT
				0	150	250	500	
R <sub>θJA</sub>	High K			149	142	138	132	°C/W
R <sub>θJA</sub>	Low K			230	185	170	150	
R <sub>θJB</sub>	High K	102.0						
R <sub>θJC</sub>	High K	43.7						
Ψ <sub>JT</sub>	High K	1.8						
Ψ <sub>JB</sub>	High K	100.2						

(1) For more information about traditional and new thermal metrics, see the *IC Package Thermal Metrics* application report, [SPRA953](#).

### ABSOLUTE MAXIMUM RATINGS

over operating free-air temperature range (unless otherwise noted) <sup>(1)</sup>

	UNIT
Supply voltage range, V <sub>DD</sub>	–0.5 V to 4.3 V
Input voltage range, V <sub>I</sub> <sup>(2)</sup> <sup>(3)</sup>	–0.5 V to V <sub>DD</sub> + 0.5 V
Output voltage range, V <sub>O</sub> <sup>(2)</sup> <sup>(3)</sup>	–0.5 V to V <sub>DD</sub> + 0.5 V
Input clamp current, I <sub>IK</sub> (V <sub>I</sub> < 0 or V <sub>I</sub> > V <sub>DD</sub> )	±50 mA
Output clamp current, I <sub>OK</sub> (V <sub>O</sub> < 0 or V <sub>O</sub> > V <sub>DD</sub> )	±50 mA
Continuous total output current, I <sub>O</sub> (V <sub>O</sub> = 0 to V <sub>DD</sub> )	±50 mA
Package thermal impedance, θ <sub>JA</sub> : PW package	230.5°C/W
Storage temperature range T <sub>stg</sub>	–65°C to 150°C

- (1) Stresses beyond those listed under “absolute maximum ratings” may cause permanent damage to the device. These are stress ratings only, and functional operation of the device at these or any other conditions beyond those indicated under “recommended operating conditions” is not implied. Exposure to absolute-maximum-rated conditions for extended periods may affect device reliability.
- (2) The input and output negative voltage ratings may be exceeded if the input and output clamp-current ratings are observed.
- (3) This value is limited to 4.6 V maximum.

## RECOMMENDED OPERATING CONDITIONS

		MIN	NOM	MAX	UNIT
Supply voltage, $V_{DD}$		2.3		3.6	V
Low-level input voltage, $V_{IL}$				$0.3 \times V_{DD}$	V
High-level input voltage, $V_{IH}$		$0.7 \times V_{DD}$			V
Input voltage, $V_I$		0		$V_{DD}$	V
High-level output current, $I_{OH}$	$V_{DD} = 2.5 \text{ V}$			-12	mA
	$V_{DD} = 3.3 \text{ V}$			-24	
Low-level output current, $I_{OL}$	$V_{DD} = 2.5 \text{ V}$			12	mA
	$V_{DD} = 3.3 \text{ V}$			24	
Operating free-air temperature, $T_A$		-40		85	°C

## TIMING REQUIREMENTS

over operating free-air temperature range (unless otherwise noted)

PARAMETER		TEST CONDITIONS	MIN	TYP	MAX	UNIT
$f_{clk}$	Clock frequency		0		200	MHz

## ELECTRICAL CHARACTERISTICS

over recommended operating free-air temperature range (unless otherwise noted)

PARAMETER		TEST CONDITIONS		MIN	TYP <sup>(1)</sup>	MAX	UNIT
$V_{IK}$	Input voltage	$V_{DD} = 3 \text{ V}$ ,	$I_I = -18 \text{ mA}$			-1.2	V
$V_{OH}$	High-level output voltage	$V_{DD} = 2.3 \text{ V}$ ,	$I_{OH} = -8 \text{ mA}$	1.8			V
		$V_{DD} = 2.3 \text{ V}$ ,	$I_{OH} = -16 \text{ mA}$	1.5			
		$V_{DD} = \text{min to max}$ ,	$I_{OH} = -1 \text{ mA}$	$V_{DD} - 0.2$			
		$V_{DD} = 3 \text{ V}$ ,	$I_{OH} = -24 \text{ mA}$	2			
		$V_{DD} = 3 \text{ V}$ ,	$I_{OH} = -12 \text{ mA}$	2.4			
$V_{OL}$	Low-level output voltage	$V_{DD} = 2.3 \text{ V}$ ,	$I_{OL} = 8 \text{ mA}$			0.5	V
		$V_{DD} = 2.3 \text{ V}$ ,	$I_{OL} = 16 \text{ mA}$			0.7	
		$V_{DD} = \text{min to max}$ ,	$I_{OL} = 1 \text{ mA}$			0.2	
		$V_{DD} = 3 \text{ V}$ ,	$I_{OL} = 24 \text{ mA}$			0.8	
		$V_{DD} = 3 \text{ V}$ ,	$I_{OL} = 12 \text{ mA}$			0.55	
$I_{OH}$	High-level output current	$V_{DD} = 3 \text{ V}$ ,	$V_O = 1 \text{ V}$	-50			mA
		$V_{DD} = 3.3 \text{ V}$ ,	$V_O = 1.65 \text{ V}$			-55	
$I_{OL}$	Low-level output current	$V_{DD} = 3 \text{ V}$ ,	$V_O = 2 \text{ V}$	60			mA
		$V_{DD} = 3.3 \text{ V}$ ,	$V_O = 1.65 \text{ V}$			70	
$I_I$	Input current	$V_I = V_O \text{ or } V_{DD}$				±5	µA
$I_{DD}$	Dynamic current, see <a href="#">Figure 5</a>	$f = 67 \text{ MHz}$ ,	$V_{DD} = 2.7 \text{ V}$			28	mA
		$f = 67 \text{ MHz}$ ,	$V_{DD} = 3.6 \text{ V}$			37	
$C_I$	Input capacitance	$V_{DD} = 3.3 \text{ V}$ ,	$V_I = 0 \text{ V or } V_{DD}$			3	pF
$C_O$	Output capacitance	$V_{DD} = 3.3 \text{ V}$ ,	$V_I = 0 \text{ V or } V_{DD}$			3.2	pF

(1) All typical values are with respect to nominal  $V_{DD}$  and  $T_A = 25^\circ\text{C}$ .

## SWITCHING CHARACTERISTICS

$V_{DD} = 2.5\text{ V} \pm 10\%$ ,  $C_L = 10\text{ pF}$  (unless otherwise noted)

PARAMETER		TEST CONDITIONS	MIN	TYP <sup>(1)</sup>	MAX	UNIT
$t_{PLH}$	Low-to-high propagation delay	See <a href="#">Figure 1</a> and <a href="#">Figure 2</a>	2	2.9	4.5	ns
$t_{PHL}$	High-to-low propagation delay		2	3	4.5	
$t_{sk(o)}$	Output skew <sup>(2)</sup>	See <a href="#">Figure 3</a>		50	150	ps
$t_r$	Output rise slew rate		1.5	2.2	4	V/ns
$t_f$	Output fall slew rate		1.5	2.2	4	V/ns

- (1) All typical values are with respect to nominal  $V_{DD}$ .  
(2) The  $t_{sk(o)}$  specification is only valid for equal loading of all outputs.

## SWITCHING CHARACTERISTICS

$V_{DD} = 3.3\text{ V} \pm 10\%$ ,  $C_L = 10\text{ pF}$  (unless otherwise noted)

PARAMETER		TEST CONDITIONS	MIN	TYP <sup>(1)</sup>	MAX	UNIT
$t_{PLH}$	Low-to-high propagation delay	See <a href="#">Figure 1</a> and <a href="#">Figure 2</a>	1.8	2.4	3	ns
$t_{PHL}$	High-to-low propagation delay		1.8	2.5	3	
$t_{sk(o)}$	Output skew <sup>(2)</sup>			50	100	ps
$t_{jitter}$	Additive phase jitter from input to output 1Y0	12 kHz to 5 MHz, $f_{out} = 30.72\text{ MHz}$		63		fs rms
		12 kHz to 20 MHz, $f_{out} = 125\text{ MHz}$		56		
$t_{sk(p)}$	Pulse skew	$V_{IH} = V_{DD}$ , $V_{IL} = 0\text{ V}$			150	ps
$t_{sk(pr)}$	Process skew			0.2	0.3	ns
$t_{sk(pp)}$	Part-to-part skew			0.25	0.4	ns
$t_{high}$	Clock high time, see <a href="#">Figure 4</a>	66 MHz	6			ns
		140 MHz	3			
$t_{low}$	Clock low time, see <a href="#">Figure 4</a>	66 MHz	6			ns
		140 MHz	3			
$t_r$	Output rise slew rate <sup>(3)</sup>	$V_O = 0.4\text{ V to }2\text{ V}$	1.5	2.7	4	V/ns
$t_f$	Output fall slew rate <sup>(3)</sup>	$V_O = 2\text{ V to }0.4\text{ V}$	1.5	2.7	4	V/ns

- (1) All typical values are with respect to nominal  $V_{DD}$ .  
(2) The  $t_{sk(o)}$  specification is only valid for equal loading of all outputs.  
(3) This symbol is according to PCI-X terminology.

PARAMETER MEASUREMENT INFORMATION

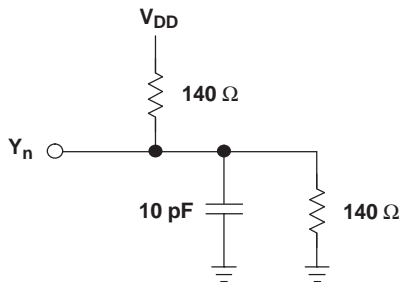

Figure 1. Test Load Circuit

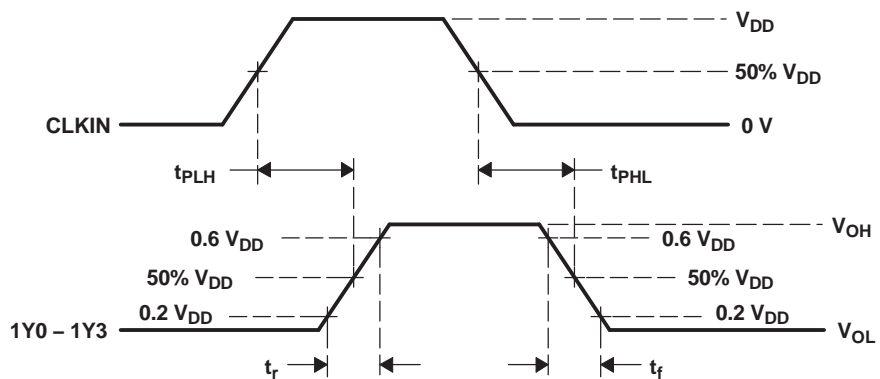

Figure 2. Voltage Waveforms Propagation Delay ( $t_{pd}$ ) Measurements

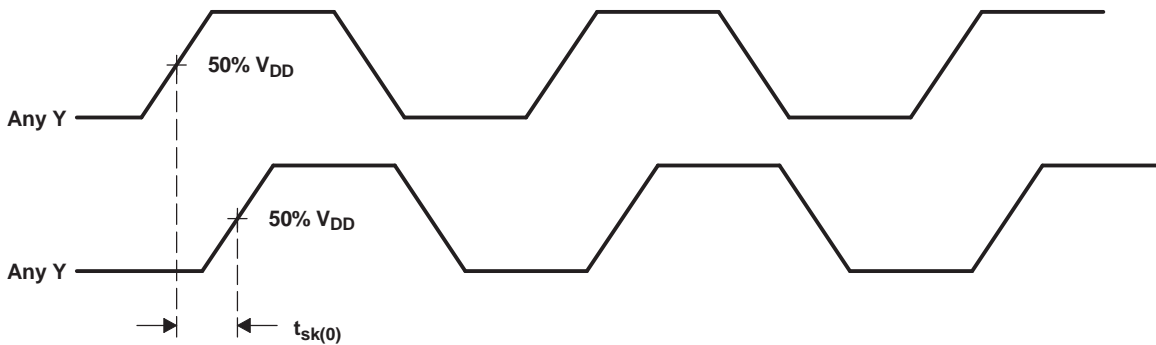
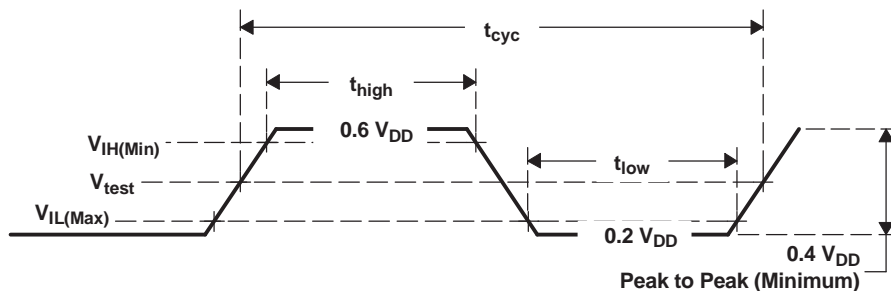

Figure 3. Output Skew

PARAMETER	VALUE	UNIT
$V_{IH(\text{Min})}$	$0.5 V_{DD}$	V
$V_{IL(\text{Max})}$	$0.35 V_{DD}$	V
$V_{\text{test}}$	$0.4 V_{DD}$	V



A. All parameters in Figure 4 are according to PCI-X 1.0 specifications.

Figure 4. Clock Waveform

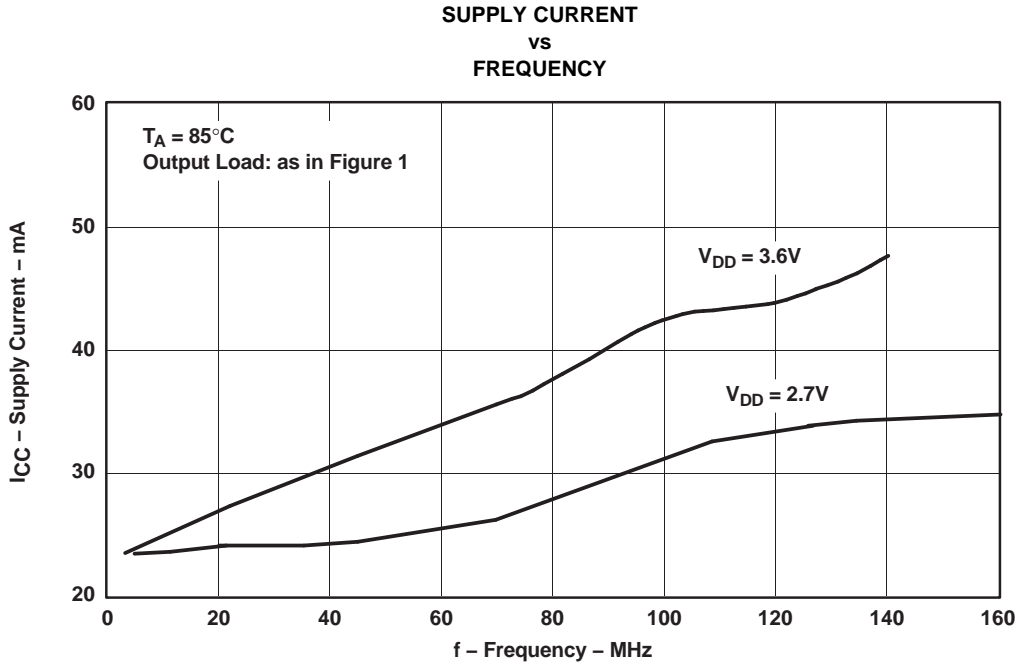

Figure 5.

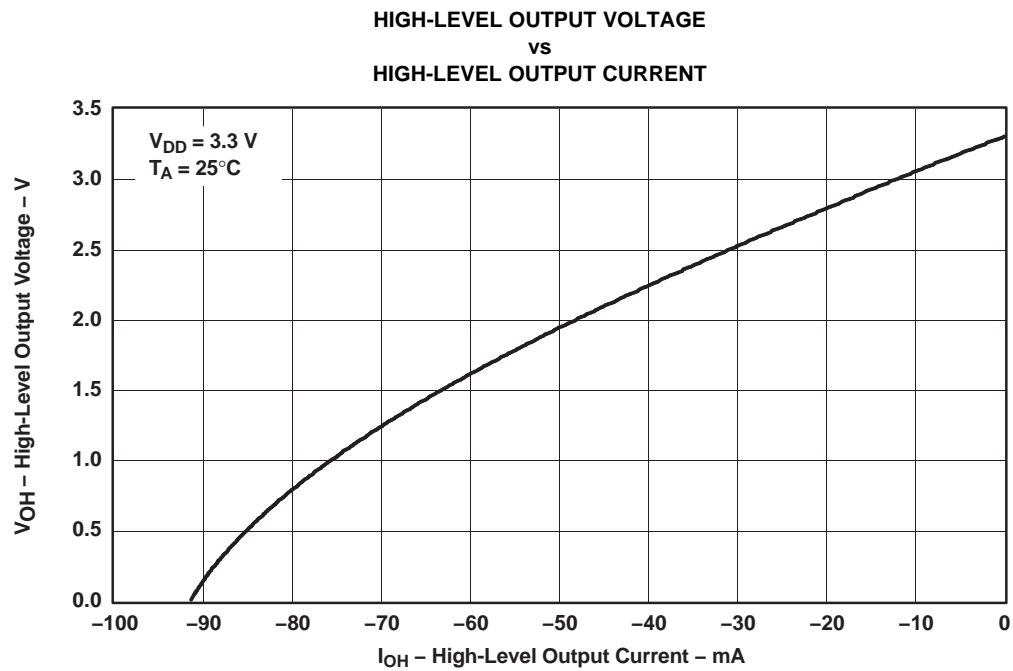
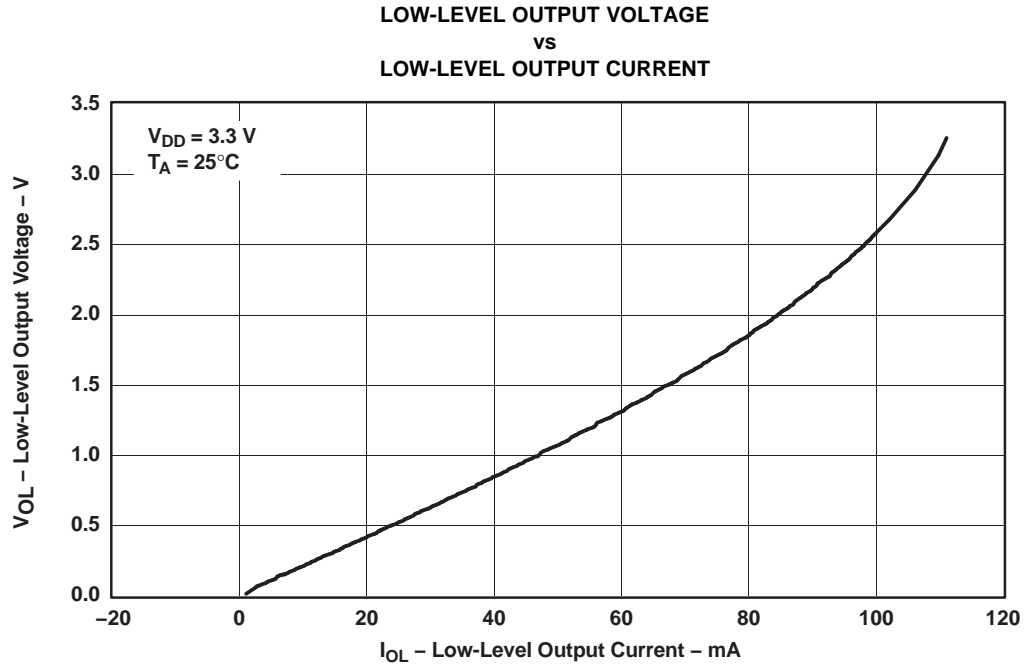

Figure 6.



## REVISION HISTORY

---

**Changes from Revision F (April 2009) to Revision G** **Page**

- Added  $\psi_{JT}$  and  $\psi_{JB}$  specs to the Thermal Information Table and changed  $R_{\theta JB}$  and  $R_{\theta JC}$  specs from 65 and 69 °C/W respectively. .... [2](#)

---

**Changes from Revision G (January 2011) to Revision H** **Page**

- Added missing characteristics graphs. .... [6](#)



**PACKAGING INFORMATION**

Orderable Device	Status (1)	Package Type	Package Drawing	Pins	Package Qty	Eco Plan (2)	Lead/Ball Finish (6)	MSL Peak Temp (3)	Op Temp (°C)	Device Marking (4/5)	Samples
CDCV304PW	ACTIVE	TSSOP	PW	8	150	Green (RoHS & no Sb/Br)	CU NIPDAU   Call TI	Level-1-260C-UNLIM	-40 to 85	CKV304	<a href="#">Samples</a>
CDCV304PWG4	ACTIVE	TSSOP	PW	8	150	Green (RoHS & no Sb/Br)	CU NIPDAU	Level-1-260C-UNLIM	-40 to 85	CKV304	<a href="#">Samples</a>
CDCV304PWR	ACTIVE	TSSOP	PW	8	2000	Green (RoHS & no Sb/Br)	CU NIPDAU   Call TI	Level-1-260C-UNLIM	-40 to 85	CKV304	<a href="#">Samples</a>
CDCV304PWRG4	ACTIVE	TSSOP	PW	8	2000	Green (RoHS & no Sb/Br)	CU NIPDAU	Level-1-260C-UNLIM	-40 to 85	CKV304	<a href="#">Samples</a>

(1) The marketing status values are defined as follows:

**ACTIVE:** Product device recommended for new designs.

**LIFEBUY:** TI has announced that the device will be discontinued, and a lifetime-buy period is in effect.

**NRND:** Not recommended for new designs. Device is in production to support existing customers, but TI does not recommend using this part in a new design.

**PREVIEW:** Device has been announced but is not in production. Samples may or may not be available.

**OBSOLETE:** TI has discontinued the production of the device.

(2) Eco Plan - The planned eco-friendly classification: Pb-Free (RoHS), Pb-Free (RoHS Exempt), or Green (RoHS & no Sb/Br) - please check <http://www.ti.com/productcontent> for the latest availability information and additional product content details.

**TBD:** The Pb-Free/Green conversion plan has not been defined.

**Pb-Free (RoHS):** TI's terms "Lead-Free" or "Pb-Free" mean semiconductor products that are compatible with the current RoHS requirements for all 6 substances, including the requirement that lead not exceed 0.1% by weight in homogeneous materials. Where designed to be soldered at high temperatures, TI Pb-Free products are suitable for use in specified lead-free processes.

**Pb-Free (RoHS Exempt):** This component has a RoHS exemption for either 1) lead-based flip-chip solder bumps used between the die and package, or 2) lead-based die adhesive used between the die and leadframe. The component is otherwise considered Pb-Free (RoHS compatible) as defined above.

**Green (RoHS & no Sb/Br):** TI defines "Green" to mean Pb-Free (RoHS compatible), and free of Bromine (Br) and Antimony (Sb) based flame retardants (Br or Sb do not exceed 0.1% by weight in homogeneous material)

(3) MSL, Peak Temp. - The Moisture Sensitivity Level rating according to the JEDEC industry standard classifications, and peak solder temperature.

(4) There may be additional marking, which relates to the logo, the lot trace code information, or the environmental category on the device.

(5) Multiple Device Markings will be inside parentheses. Only one Device Marking contained in parentheses and separated by a "~" will appear on a device. If a line is indented then it is a continuation of the previous line and the two combined represent the entire Device Marking for that device.

(6) Lead/Ball Finish - Orderable Devices may have multiple material finish options. Finish options are separated by a vertical ruled line. Lead/Ball Finish values may wrap to two lines if the finish value exceeds the maximum column width.

**Important Information and Disclaimer:** The information provided on this page represents TI's knowledge and belief as of the date that it is provided. TI bases its knowledge and belief on information provided by third parties, and makes no representation or warranty as to the accuracy of such information. Efforts are underway to better integrate information from third parties. TI has taken and continues to take reasonable steps to provide representative and accurate information but may not have conducted destructive testing or chemical analysis on incoming materials and chemicals. TI and TI suppliers consider certain information to be proprietary, and thus CAS numbers and other limited information may not be available for release.

In no event shall TI's liability arising out of such information exceed the total purchase price of the TI part(s) at issue in this document sold by TI to Customer on an annual basis.

**OTHER QUALIFIED VERSIONS OF CDCV304 :**

- Enhanced Product: [CDCV304-EP](#)

NOTE: Qualified Version Definitions:

- Enhanced Product - Supports Defense, Aerospace and Medical Applications

## TAPE AND REEL INFORMATION



### QUADRANT ASSIGNMENTS FOR PIN 1 ORIENTATION IN TAPE



\*All dimensions are nominal

Device	Package Type	Package Drawing	Pins	SPQ	Reel Diameter (mm)	Reel Width W1 (mm)	A0 (mm)	B0 (mm)	K0 (mm)	P1 (mm)	W (mm)	Pin1 Quadrant
CDCV304PWR	TSSOP	PW	8	2000	330.0	12.4	7.0	3.6	1.6	8.0	12.0	Q1

TAPE AND REEL BOX DIMENSIONS



\*All dimensions are nominal

Device	Package Type	Package Drawing	Pins	SPQ	Length (mm)	Width (mm)	Height (mm)
CDCV304PWR	TSSOP	PW	8	2000	367.0	367.0	35.0

PW0008A



**PACKAGE OUTLINE**  
**TSSOP - 1.2 mm max height**

SMALL OUTLINE PACKAGE



4221848/A 02/2015

NOTES:

1. All linear dimensions are in millimeters. Any dimensions in parenthesis are for reference only. Dimensioning and tolerancing per ASME Y14.5M.
2. This drawing is subject to change without notice.
3. This dimension does not include mold flash, protrusions, or gate burrs. Mold flash, protrusions, or gate burrs shall not exceed 0.15 mm per side.
4. This dimension does not include interlead flash. Interlead flash shall not exceed 0.25 mm per side.
5. Reference JEDEC registration MO-153, variation AA.

# EXAMPLE BOARD LAYOUT

PW0008A

TSSOP - 1.2 mm max height

SMALL OUTLINE PACKAGE



LAND PATTERN EXAMPLE  
SCALE:10X



SOLDER MASK DETAILS  
NOT TO SCALE

4221848/A 02/2015

NOTES: (continued)

- 6. Publication IPC-7351 may have alternate designs.
- 7. Solder mask tolerances between and around signal pads can vary based on board fabrication site.

# EXAMPLE STENCIL DESIGN

PW0008A

TSSOP - 1.2 mm max height

SMALL OUTLINE PACKAGE



SOLDER PASTE EXAMPLE  
BASED ON 0.125 mm THICK STENCIL  
SCALE:10X

4221848/A 02/2015

NOTES: (continued)

8. Laser cutting apertures with trapezoidal walls and rounded corners may offer better paste release. IPC-7525 may have alternate design recommendations.
9. Board assembly site may have different recommendations for stencil design.

## IMPORTANT NOTICE

Texas Instruments Incorporated and its subsidiaries (TI) reserve the right to make corrections, enhancements, improvements and other changes to its semiconductor products and services per JESD46, latest issue, and to discontinue any product or service per JESD48, latest issue. Buyers should obtain the latest relevant information before placing orders and should verify that such information is current and complete. All semiconductor products (also referred to herein as "components") are sold subject to TI's terms and conditions of sale supplied at the time of order acknowledgment.

TI warrants performance of its components to the specifications applicable at the time of sale, in accordance with the warranty in TI's terms and conditions of sale of semiconductor products. Testing and other quality control techniques are used to the extent TI deems necessary to support this warranty. Except where mandated by applicable law, testing of all parameters of each component is not necessarily performed.

TI assumes no liability for applications assistance or the design of Buyers' products. Buyers are responsible for their products and applications using TI components. To minimize the risks associated with Buyers' products and applications, Buyers should provide adequate design and operating safeguards.

TI does not warrant or represent that any license, either express or implied, is granted under any patent right, copyright, mask work right, or other intellectual property right relating to any combination, machine, or process in which TI components or services are used. Information published by TI regarding third-party products or services does not constitute a license to use such products or services or a warranty or endorsement thereof. Use of such information may require a license from a third party under the patents or other intellectual property of the third party, or a license from TI under the patents or other intellectual property of TI.

Reproduction of significant portions of TI information in TI data books or data sheets is permissible only if reproduction is without alteration and is accompanied by all associated warranties, conditions, limitations, and notices. TI is not responsible or liable for such altered documentation. Information of third parties may be subject to additional restrictions.

Resale of TI components or services with statements different from or beyond the parameters stated by TI for that component or service voids all express and any implied warranties for the associated TI component or service and is an unfair and deceptive business practice. TI is not responsible or liable for any such statements.

Buyer acknowledges and agrees that it is solely responsible for compliance with all legal, regulatory and safety-related requirements concerning its products, and any use of TI components in its applications, notwithstanding any applications-related information or support that may be provided by TI. Buyer represents and agrees that it has all the necessary expertise to create and implement safeguards which anticipate dangerous consequences of failures, monitor failures and their consequences, lessen the likelihood of failures that might cause harm and take appropriate remedial actions. Buyer will fully indemnify TI and its representatives against any damages arising out of the use of any TI components in safety-critical applications.

In some cases, TI components may be promoted specifically to facilitate safety-related applications. With such components, TI's goal is to help enable customers to design and create their own end-product solutions that meet applicable functional safety standards and requirements. Nonetheless, such components are subject to these terms.

No TI components are authorized for use in FDA Class III (or similar life-critical medical equipment) unless authorized officers of the parties have executed a special agreement specifically governing such use.

Only those TI components which TI has specifically designated as military grade or "enhanced plastic" are designed and intended for use in military/aerospace applications or environments. Buyer acknowledges and agrees that any military or aerospace use of TI components which have **not** been so designated is solely at the Buyer's risk, and that Buyer is solely responsible for compliance with all legal and regulatory requirements in connection with such use.

TI has specifically designated certain components as meeting ISO/TS16949 requirements, mainly for automotive use. In any case of use of non-designated products, TI will not be responsible for any failure to meet ISO/TS16949.

### Products

Audio	<a href="http://www.ti.com/audio">www.ti.com/audio</a>
Amplifiers	<a href="http://amplifier.ti.com">amplifier.ti.com</a>
Data Converters	<a href="http://dataconverter.ti.com">dataconverter.ti.com</a>
DLP® Products	<a href="http://www.dlp.com">www.dlp.com</a>
DSP	<a href="http://dsp.ti.com">dsp.ti.com</a>
Clocks and Timers	<a href="http://www.ti.com/clocks">www.ti.com/clocks</a>
Interface	<a href="http://interface.ti.com">interface.ti.com</a>
Logic	<a href="http://logic.ti.com">logic.ti.com</a>
Power Mgmt	<a href="http://power.ti.com">power.ti.com</a>
Microcontrollers	<a href="http://microcontroller.ti.com">microcontroller.ti.com</a>
RFID	<a href="http://www.ti-rfid.com">www.ti-rfid.com</a>
OMAP Applications Processors	<a href="http://www.ti.com/omap">www.ti.com/omap</a>
Wireless Connectivity	<a href="http://www.ti.com/wirelessconnectivity">www.ti.com/wirelessconnectivity</a>

### Applications

Automotive and Transportation	<a href="http://www.ti.com/automotive">www.ti.com/automotive</a>
Communications and Telecom	<a href="http://www.ti.com/communications">www.ti.com/communications</a>
Computers and Peripherals	<a href="http://www.ti.com/computers">www.ti.com/computers</a>
Consumer Electronics	<a href="http://www.ti.com/consumer-apps">www.ti.com/consumer-apps</a>
Energy and Lighting	<a href="http://www.ti.com/energy">www.ti.com/energy</a>
Industrial	<a href="http://www.ti.com/industrial">www.ti.com/industrial</a>
Medical	<a href="http://www.ti.com/medical">www.ti.com/medical</a>
Security	<a href="http://www.ti.com/security">www.ti.com/security</a>
Space, Avionics and Defense	<a href="http://www.ti.com/space-avionics-defense">www.ti.com/space-avionics-defense</a>
Video and Imaging	<a href="http://www.ti.com/video">www.ti.com/video</a>

### TI E2E Community

[e2e.ti.com](http://e2e.ti.com)