

LM2940x 1-A Low Dropout Regulator

1 Features

- Input Voltage Range = 6 V to 26 V
- Dropout Voltage Typically 0.5 V at $I_{OUT} = 1$ A
- Output Current in Excess of 1 A
- Output Voltage Trimmed Before Assembly
- Reverse Battery Protection
- Internal Short Circuit Current Limit
- Mirror Image Insertion Protection
- P⁺ Product Enhancement Tested

2 Applications

- Post Regulator for Switching Supplies
- Logic Power Supplies
- Industrial Instrumentation

3 Description

The LM2940-N and LM2940C positive voltage regulators feature the ability to source 1 A of output current with a dropout voltage of typically 0.5 V and a maximum of 1 V over the entire temperature range. Furthermore, a quiescent current reduction circuit has been included which reduces the ground current when the differential between the input voltage and the output voltage exceeds approximately 3 V. The quiescent current with 1 A of output current and an input-output differential of 5 V is therefore only 30 mA. Higher quiescent currents only exist when the regulator is in the dropout mode ($V_{IN} - V_{OUT} \leq 3$ V).

Designed also for vehicular applications, the LM2940-N and LM2940C and all regulated circuitry are protected from reverse battery installations or 2-battery jumps. During line transients, such as load dump when the input voltage can momentarily exceed the specified maximum operating voltage, the regulator will automatically shut down to protect both the internal circuits and the load. The LM2940-N and LM2940C cannot be harmed by temporary mirror-image insertion. Familiar regulator features such as short circuit and thermal overload protection are also provided.

Device Information⁽¹⁾

| PART NUMBER | PACKAGE | BODY SIZE (NOM) |
|-------------|-------------|----------------------|
| LM2940-N | SOT-223 (4) | 6.50 mm x 3.50 mm |
| | WSON (8) | 4.00 mm x 4.00 mm |
| | TO-263 (3) | 10.18 mm x 8.41 mm |
| | TO-220 (3) | 14.986 mm x 10.16 mm |
| LM2940C | TO-263 (3) | 10.18 mm x 8.41 mm |
| | TO-220 (3) | 14.986 mm x 10.16 mm |

(1) For all available packages, see the orderable addendum at the end of the datasheet.

Simplified Schematic

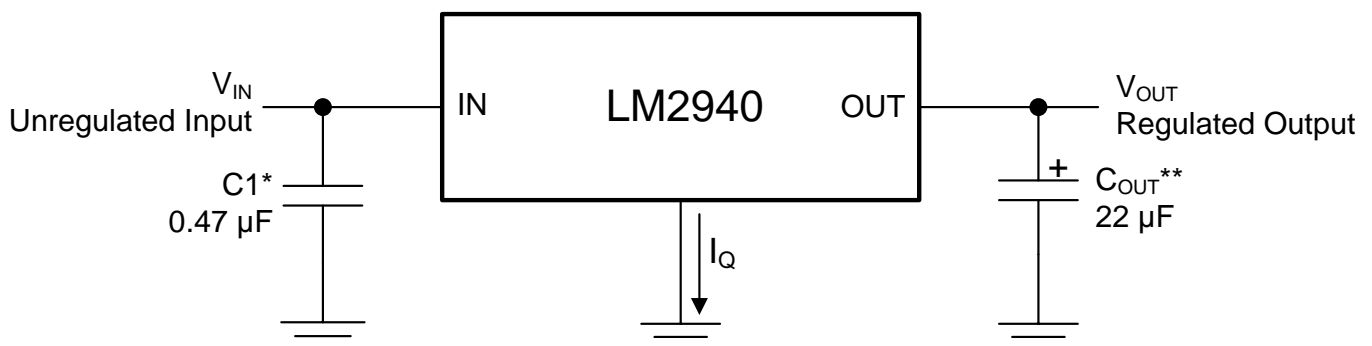

*Required if regulator is located far from power supply filter.

** C_{OUT} must be at least 22 μ F to maintain stability. May be increased without bound to maintain regulation during transients. Locate as close as possible to the regulator. This capacitor must be rated over the same operating temperature range as the regulator and the ESR is critical; see curve.



5 Pin Configuration and Functions

**DDPAK/TO-263 (KTT) Package
3 Pins
Top View**

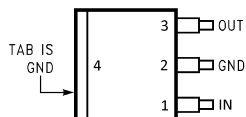

**TO-220 (NDE) Package
4 Pins
Front View**

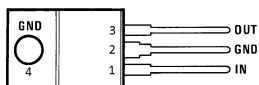

**SOT-223 (DCY) Package
3 Pins
Front View**

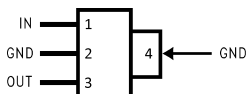

**DDPAK/TO-263 (KTT) Package
Side View**



**WSON (NGN) Package
8 Pins
Top View**

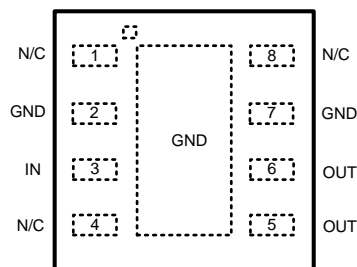

Pin 2 and pin 7 are fused to center DAP
Pin 5 and 6 need to be tied together on PCB board

Pin Functions

| NAME | PIN | | | | I/O | DESCRIPTION |
|------|-----|-----|-----|---------|-----|--|
| | NDE | KTT | DCY | NGN | | |
| IN | 1 | 1 | 1 | 3 | I | Unregulated input voltage. |
| GND | 2 | 2 | 2 | 2 | — | Ground |
| OUT | 3 | 3 | 3 | 5, 6 | O | Regulated output voltage. This pin requires an output capacitor to maintain stability. See Detailed Design Procedure for output capacitor details. |
| GND | 4 | 4 | 4 | 7 | — | Ground |
| N/C | — | — | — | 1, 4, 8 | — | No connection |

6 Specifications

6.1 Absolute Maximum Ratings⁽¹⁾⁽²⁾

| | | MIN | MAX | UNIT |
|---|---------------------------|-----|--------------------|------|
| LM2940-N KTT, NDE, DCY \leq 100 ms | | | 60 | V |
| LM2940C KTT, NDE \leq 1 ms | | | 45 | |
| Internal power dissipation ⁽³⁾ | | | Internally Limited | |
| Maximum junction temperature | | | 150 | °C |
| Soldering temperature ⁽⁴⁾ | TO-220 (NDE), Wave (10 s) | | 260 | |
| | DDPAK/TO-263 (KTT) (30 s) | | 235 | |
| | SOT-223 (DCY) (30 s) | | 260 | |
| | WSON-8 (NGN) (30 s) | | 235 | |
| Storage temperature, T_{stg} | | -65 | 150 | |

- (1) Absolute Maximum Ratings are limits beyond which damage to the device may occur. *Recommended Operating Conditions* are conditions under which the device functions but the specifications might not be ensured. For ensured specifications and test conditions see the *Electrical Characteristics (5 V and 8 V)*.
- (2) If Military/Aerospace specified devices are required, please contact the Texas Instruments Sales Office/ Distributors for availability and specifications.
- (3) The maximum allowable power dissipation is a function of the maximum junction temperature, T_J , the junction-to-ambient thermal resistance, $R_{\theta JA}$, and the ambient temperature, T_A . Exceeding the maximum allowable power dissipation will cause excessive die temperature, and the regulator will go into thermal shutdown. The value of $R_{\theta JA}$ (for devices in still air with no heatsink) is 23.3°C/W for the TO-220 package, 40.9°C/W for the DDPK/TO-263 package, and 59.3°C/W for the SOT-223 package. The effective value of $R_{\theta JA}$ can be reduced by using a heatsink (see *Heatsinking* for specific information on heatsinking). The value of $R_{\theta JA}$ for the WSON package is specifically dependent on PCB trace area, trace material, and the number of layers and thermal vias. For improved thermal resistance and power dissipation for the WSON package, refer to Application Note AN-1187 *Leadless Leadframe Package (LLP) (SNOA401)*. It is recommended that 6 vias be placed under the center pad to improve thermal performance.
- (4) Refer to JEDEC J-STD-020C for surface mount device (SMD) package reflow profiles and conditions. Unless otherwise stated, the temperature and time are for Sn-Pb (STD) only.

6.2 ESD Ratings

| | | VALUE | UNIT |
|-------------|-------------------------|---|-----------------|
| $V_{(ESD)}$ | Electrostatic discharge | Human-body model (HBM), per ANSI/ESDA/JEDEC JS-001 ⁽¹⁾ | ± 2000 V |

- (1) JEDEC document JEP155 states that 500-V HBM allows safe manufacturing with a standard ESD control process.

6.3 Recommended Operating Conditions

over operating free-air temperature range (unless otherwise noted)

| | | MIN | MAX | UNIT |
|---------------|----------------------------|-----|-----|------|
| Input voltage | | 6 | 26 | V |
| Temperature | LM2940-N NDE, LM2940-N KTT | -40 | 125 | °C |
| | LM2940C NDE, LM2940C KTT | 0 | 125 | |
| | LM2940-N DCY | -40 | 85 | |
| | LM2940-N NGN | -40 | 125 | |

6.4 Thermal Information

| THERMAL METRIC ⁽¹⁾ | | LM2940-N, LM2940C | | LM2940-N | | UNIT |
|-------------------------------|---|-------------------|--------------------|---------------|-----------|------|
| | | TO-220 (NDE) | DDPAK/TO-263 (KTT) | SOT-223 (DCY) | WSO (NGN) | |
| | | 3 PINS | 3 PINS | 4 PINS | 8 PINS | |
| R _{θJA} | Junction-to-ambient thermal resistance ⁽²⁾ | 23.3 | 40.9 | 59.3 | 40.5 | °C/W |
| R _{θJC(top)} | Junction-to-case (top) thermal resistance | 16.1 | 43.5 | 38.9 | 26.2 | |
| R _{θJB} | Junction-to-board thermal resistance | 4.8 | 23.5 | 8.1 | 17.0 | |
| Ψ _{JT} | Junction-to-top characterization parameter | 2.7 | 10.3 | 1.7 | 0.2 | |
| Ψ _{JB} | Junction-to-board characterization parameter | 4.8 | 22.5 | 8.0 | 17.2 | |
| R _{θJC(bot)} | Junction-to-case (bottom) thermal resistance | 1.1 | 0.8 | n/a | 3.2 | |

(1) For more information about traditional and new thermal metrics, see the *IC Package Thermal Metrics* application report, [SPRA953](#).

(2) Thermal information for the TO-220 package is for a package vertically mounted with a heat sink in the middle of a PCB which is compliant to the JEDEC HIGH-K 2s2p (JESD51-7). The heatsink-to-ambient thermal resistance, R_{θSA}, is 21.7°C/W. See [Heatsinking TO-220 Package Parts](#) for more information.

6.5 Electrical Characteristics (5 V and 8 V)

Unless otherwise specified: V_{IN} = V_{OUT} + 5 V, I_{OUT} = 1 A and C_{OUT} = 22 μF. MIN (minimum) and MAX (maximum) limits apply over the recommended operating temperature range, unless otherwise noted; typical limits apply for T_A = T_J = 25°C.

| PARAMETER | TEST CONDITIONS | 5 V | | | 8 V | | | UNIT |
|----------------------|--|--|------|------|------|------|-----|------------|
| | | MIN | TYP | MAX | MIN | TYP | MAX | |
| Input voltage | 5 mA ≤ I _{OUT} ≤ 1 A | 6.25 | | 26 | 9.4 | | 26 | V |
| Output voltage | 5 mA ≤ I _{OUT} ≤ 1 A | 4.75 | 5 | 5.25 | 7.6 | 8 | 8.4 | |
| | | 5 mA ≤ I _{OUT} ≤ 1 A, T _J = 25°C | 4.85 | 5 | 5.15 | 7.76 | 8 | 8.24 |
| Line regulation | V _{OUT} + 2 V ≤ V _{IN} ≤ 26 V, I _{OUT} = 5 mA T _J = 25°C | | 20 | 50 | | 20 | 80 | mV |
| Load regulation | 50 mA ≤ I _{OUT} ≤ 1 A | LM2940-N | 35 | 80 | 55 | 130 | | mV |
| | 50 mA ≤ I _{OUT} ≤ 1 A T _J = 25°C | LM2940-N | 35 | 50 | 55 | 80 | | |
| | | LM2940C | 35 | 50 | 55 | 80 | | |
| Output impedance | 100 mADC, 20 mArms, f _{OUT} = 120 Hz | | 35 | | | 55 | | mΩ |
| Quiescent current | V _{OUT} + 2 V ≤ V _{IN} ≤ 26 V, I _{OUT} = 5 mA | LM2940-N | 10 | 20 | 10 | 20 | | mA |
| | V _{OUT} + 2 V ≤ V _{IN} ≤ 26 V, I _{OUT} = 5 mA T _J = 25°C | LM2940-N | 10 | 15 | 10 | 15 | | |
| | | LM2940C | 10 | 15 | | | | |
| | V _{IN} = V _{OUT} + 5 V, I _{OUT} = 1 A | | 30 | 60 | 30 | 60 | | |
| | V _{IN} = V _{OUT} + 5 V, I _{OUT} = 1 A T _J = 25°C | | 30 | 45 | 30 | 45 | | |
| Output noise voltage | 10 Hz to 100 kHz, I _{OUT} = 5 mA | | 150 | | | 240 | | μVrms |
| Ripple rejection | f _{OUT} = 120 Hz, 1 V _{rms} , I _{OUT} = 100 mA | LM2940-N | 54 | 72 | 48 | 66 | | dB |
| | f _{OUT} = 120 Hz, 1 V _{rms} , I _{OUT} = 100 mA T _J = 25°C | LM2940-N | 60 | 72 | 54 | 66 | | |
| | | LM2940C | 60 | 72 | 54 | 66 | | |
| Long-term stability | | | 20 | | | 32 | | mV/1000 Hr |
| Dropout voltage | I _{OUT} = 1 A | | 0.5 | 1 | 0.5 | 1 | | V |
| | I _{OUT} = 1 A, T _J = 25°C | | 0.5 | 0.8 | 0.5 | 0.8 | | |
| | I _{OUT} = 100 mA | | 110 | 200 | 110 | 200 | | mV |
| | I _{OUT} = 100 mA, T _J = 25°C | | 110 | 150 | 110 | 150 | | |

Electrical Characteristics (5 V and 8 V) (continued)

Unless otherwise specified: $V_{IN} = V_{OUT} + 5\text{ V}$, $I_{OUT} = 1\text{ A}$ and $C_{OUT} = 22\text{ }\mu\text{F}$. MIN (minimum) and MAX (maximum) limits apply over the recommended operating temperature range, unless otherwise noted; typical limits apply for $T_A = T_J = 25^\circ\text{C}$.

| PARAMETER | TEST CONDITIONS | | 5 V | | | 8 V | | | UNIT |
|--|--|----------|-----|-----|-----|-----|-----|-----|------|
| | | | MIN | TYP | MAX | MIN | TYP | MAX | |
| Short-circuit current | See ⁽¹⁾ , $T_J = 25^\circ\text{C}$ | | 1.6 | 1.9 | | 1.6 | 1.9 | | A |
| Maximum line transient | $R_{OUT} = 100\text{ }\Omega$, $T \leq 100\text{ ms}$ | LM2940-N | 60 | 75 | | 60 | 75 | | V |
| | $R_{OUT} = 100\text{ }\Omega$, $T \leq 1\text{ ms}$ $T_J = 25^\circ\text{C}$ | LM2940C | 45 | 55 | | 45 | 55 | | |
| Reverse polarity DC input voltage | $R_{OUT} = 100\text{ }\Omega$ | LM2940-N | -15 | -30 | | -15 | -30 | | V |
| | $R_{OUT} = 100\text{ }\Omega$ $T_J = 25^\circ\text{C}$ | LM2940C | -15 | -30 | | -15 | -30 | | |
| Reverse polarity Transient Input Voltage | $R_{OUT} = 100\text{ }\Omega$, $T \leq 100\text{ ms}$ | LM2940-N | -50 | -75 | | -50 | -75 | | V |
| | $R_{OUT} = 100\text{ }\Omega$, $T \leq 1\text{ ms}$ | LM2940C | -45 | -55 | | | | | |

(1) Output current will decrease with increasing temperature but will not drop below 1 A at the maximum specified temperature.

6.6 Electrical Characteristics (9 V and 10 V)

Unless otherwise specified: $V_{IN} = V_{OUT} + 5\text{ V}$, $I_{OUT} = 1\text{ A}$ and $C_{OUT} = 22\text{ }\mu\text{F}$. MIN (minimum) and MAX (maximum) limits apply over the recommended operating temperature range, unless otherwise noted; typical limits apply for $T_A = T_J = 25^\circ\text{C}$.

| PARAMETER | TEST CONDITIONS | | 9 V | | | 10 V | | | UNIT |
|--|--|---|------|------|------|------|-----|------|------------------|
| | | | MIN | TYP | MAX | MIN | TYP | MAX | |
| Input voltage | $5\text{ mA} \leq I_{OUT} \leq 1\text{ A}$ | | 10.5 | | 26 | 11.5 | | 26 | V |
| Output voltage | $5\text{ mA} \leq I_{OUT} \leq 1\text{ A}$ | | 8.55 | 9 | 9.45 | 9.5 | 10 | 10.5 | |
| | | $5\text{ mA} \leq I_{OUT} \leq 1\text{ A}$, $T_J = 25^\circ\text{C}$ | | 8.73 | 9 | 9.27 | 9.7 | 10 | 10.3 |
| Line regulation | $V_{OUT} + 2\text{ V} \leq V_{IN} \leq 26\text{ V}$, $I_{OUT} = 5\text{ mA}$ $T_J = 25^\circ\text{C}$ | | | 20 | 90 | | 20 | 100 | mV |
| Load regulation | $50\text{ mA} \leq I_{OUT} \leq 1\text{ A}$ | LM2940-N | | 60 | 150 | | 65 | 165 | mV |
| | $50\text{ mA} \leq I_{OUT} \leq 1\text{ A}$ $T_J = 25^\circ\text{C}$ | LM2940-N | | 60 | 90 | | 65 | 100 | |
| | | LM2940C | | 60 | 90 | | | | |
| Output impedance | 100 mADC, 20 mArms, $f_{OUT} = 120\text{ Hz}$ | | | 60 | | | 65 | | m Ω |
| Quiescent current | $V_{OUT} + 2\text{ V} \leq V_{IN} \leq 26\text{ V}$, $I_{OUT} = 5\text{ mA}$ | LM2940-N | | 10 | 20 | | 10 | 20 | mA |
| | $V_{OUT} + 2\text{ V} \leq V_{IN} \leq 26\text{ V}$, $I_{OUT} = 5\text{ mA}$ $T_J = 25^\circ\text{C}$ | LM2940-N | | 10 | 15 | | | 15 | |
| | | LM2940C | | 10 | 15 | | | | |
| | $V_{IN} = V_{OUT} + 5\text{ V}$, $I_{OUT} = 1\text{ A}$ | | | 30 | 60 | | 30 | 60 | |
| $V_{IN} = V_{OUT} + 5\text{ V}$, $I_{OUT} = 1\text{ A}$ $T_J = 25^\circ\text{C}$ | | | 30 | 45 | | 30 | 45 | | |
| Output noise voltage | 10 Hz to 100 kHz, $I_{OUT} = 5\text{ mA}$ | | | 270 | | | 300 | | μVrms |
| Ripple rejection | $f_{OUT} = 120\text{ Hz}$, 1 Vrms $I_{OUT} = 100\text{ mA}$ | LM2940-N | 46 | 64 | | 45 | 63 | | dB |
| | $f_{OUT} = 120\text{ Hz}$, 1 Vrms $I_{OUT} = 100\text{ mA}$ $T_J = 25^\circ\text{C}$ | LM2940-N | 52 | 64 | | 51 | 63 | | |
| | | LM2940C | 52 | 64 | | | | | |
| Long-term stability | | | | 34 | | | 36 | | mV/1000 Hr |
| Dropout voltage | $I_{OUT} = 1\text{ A}$ | | | 0.5 | 1 | | 0.5 | 1 | V |
| | $I_{OUT} = 1\text{ A}$, $T_J = 25^\circ\text{C}$ | | | 0.5 | 0.8 | | 0.5 | 0.8 | |
| | $I_{OUT} = 100\text{ mA}$ | | | 110 | 200 | | 110 | 200 | mV |
| | $I_{OUT} = 100\text{ mA}$, $T_J = 25^\circ\text{C}$ | | | 110 | 150 | | 110 | 150 | |

Electrical Characteristics (9 V and 10 V) (continued)

Unless otherwise specified: $V_{IN} = V_{OUT} + 5\text{ V}$, $I_{OUT} = 1\text{ A}$ and $C_{OUT} = 22\text{ }\mu\text{F}$. MIN (minimum) and MAX (maximum) limits apply over the recommended operating temperature range, unless otherwise noted; typical limits apply for $T_A = T_J = 25^\circ\text{C}$.

| PARAMETER | TEST CONDITIONS | | 9 V | | | 10 V | | | UNIT |
|--|--|----------|-----|-----|-----|------|-----|-----|------|
| | | | MIN | TYP | MAX | MIN | TYP | MAX | |
| Short-circuit current | See ⁽¹⁾ , $T_J = 25^\circ\text{C}$ | | 1.6 | 1.9 | | 1.6 | 1.9 | | A |
| Maximum line transient | $R_{OUT} = 100\text{ }\Omega$, $T \leq 100\text{ ms}$ | LM2940-N | 60 | 75 | | 60 | 75 | | V |
| | $R_{OUT} = 100\text{ }\Omega$, $T \leq 100\text{ ms}$ $T_J = 25^\circ\text{C}$ | LM2940C | 45 | 55 | | | | | |
| Reverse polarity DC input voltage | $R_{OUT} = 100\text{ }\Omega$ | LM2940-N | -15 | -30 | | -15 | -30 | | V |
| | $R_{OUT} = 100\text{ }\Omega$ $T_J = 25^\circ\text{C}$ | LM2940C | -15 | -30 | | | | | |
| Reverse polarity Transient Input Voltage | $R_{OUT} = 100\text{ }\Omega$, $T \leq 100\text{ ms}$ | LM2940-N | -50 | -75 | | -50 | -75 | | V |
| | | LM2940C | -45 | -55 | | | | | |

(1) Output current will decrease with increasing temperature but will not drop below 1 A at the maximum specified temperature.

6.7 Electrical Characteristics (12 V and 15 V)

Unless otherwise specified: $V_{IN} = V_{OUT} + 5\text{ V}$, $I_{OUT} = 1\text{ A}$ and $C_{OUT} = 22\text{ }\mu\text{F}$. MIN (minimum) and MAX (maximum) limits apply over the recommended operating temperature range, unless otherwise noted; typical limits apply for $T_A = T_J = 25^\circ\text{C}$.

| PARAMETER | TEST CONDITIONS | | 12 V | | | 15 V | | | UNIT |
|----------------------|--|---|-------|-------|------|-------|-------|-------|------------------|
| | | | MIN | TYP | MAX | MIN | TYP | MAX | |
| Input voltage | $5\text{ mA} \leq I_{OUT} \leq 1\text{ A}$ | | 13.6 | | 26 | 16.75 | | 26 | V |
| Output voltage | $5\text{ mA} \leq I_{OUT} \leq 1\text{ A}$ | | 11.40 | 12 | 12.6 | 14.25 | 15 | 15.75 | |
| | | $5\text{ mA} \leq I_{OUT} \leq 1\text{ A}$, $T_J = 25^\circ\text{C}$ | | 11.64 | 12 | 12.36 | 14.55 | 15 | 15.45 |
| Line regulation | $V_{OUT} + 2\text{ V} \leq V_{IN} \leq 26\text{ V}$, $I_{OUT} = 5\text{ mA}$ $T_J = 25^\circ\text{C}$ | | | 20 | 120 | | 20 | 150 | mV |
| Load regulation | $50\text{ mA} \leq I_{OUT} \leq 1\text{ A}$ | LM2940-N | | 55 | 200 | | | | mV |
| | $50\text{ mA} \leq I_{OUT} \leq 1\text{ A}$ $T_J = 25^\circ\text{C}$ | LM2940-N | | 55 | 120 | | | | |
| | | LM2940C | | 55 | 120 | | 70 | 150 | |
| Output impedance | 100 mADC, 20 mArms, $f_{OUT} = 120\text{ Hz}$ | | | 80 | | | 100 | | m Ω |
| Quiescent current | $V_{OUT} + 2\text{ V} \leq V_{IN} \leq 26\text{ V}$, $I_{OUT} = 5\text{ mA}$ | LM2940-N | | 10 | 20 | | | | mA |
| | $V_{OUT} + 2\text{ V} \leq V_{IN} \leq 26\text{ V}$, $I_{OUT} = 5\text{ mA}$ $T_J = 25^\circ\text{C}$ | LM2940-N | | 10 | 15 | | | | |
| | | LM2940C | | 10 | 15 | | 10 | 15 | |
| | $V_{IN} = V_{OUT} + 5\text{ V}$, $I_{OUT} = 1\text{ A}$ | | | 30 | 60 | | 30 | 60 | |
| | $V_{IN} = V_{OUT} + 5\text{ V}$, $I_{OUT} = 1\text{ A}$ $T_J = 25^\circ\text{C}$ | | | 30 | 45 | | 30 | 45 | |
| Output noise voltage | 10 Hz to 100 kHz, $I_{OUT} = 5\text{ mA}$ | | | 360 | | | 450 | | μVrms |
| Ripple rejection | $f_{OUT} = 120\text{ Hz}$, 1 Vrms , $I_{OUT} = 100\text{ mA}$ | LM2940-N | 48 | 66 | | | | | dB |
| | $f_{OUT} = 120\text{ Hz}$, 1 Vrms , $I_{OUT} = 100\text{ mA}$ $T_J = 25^\circ\text{C}$ | LM2940-N | 54 | 66 | | | | | |
| | | LM2940C | 54 | 66 | | 52 | 64 | | |
| Long-term stability | | | | 48 | | | 60 | | mV/1000 Hr |
| Dropout voltage | $I_{OUT} = 1\text{ A}$ | | | 0.5 | 1 | | 0.5 | 1 | V |
| | $I_{OUT} = 1\text{ A}$, $T_J = 25^\circ\text{C}$ | | | 0.5 | 0.8 | | 0.5 | 0.8 | |
| | $I_{OUT} = 100\text{ mA}$ | | | 110 | 200 | | 110 | 200 | mV |
| | $I_{OUT} = 100\text{ mA}$, $T_J = 25^\circ\text{C}$ | | | 110 | 150 | | 110 | 150 | |

Electrical Characteristics (12 V and 15 V) (continued)

Unless otherwise specified: $V_{IN} = V_{OUT} + 5\text{ V}$, $I_{OUT} = 1\text{ A}$ and $C_{OUT} = 22\text{ }\mu\text{F}$. MIN (minimum) and MAX (maximum) limits apply over the recommended operating temperature range, unless otherwise noted; typical limits apply for $T_A = T_J = 25^\circ\text{C}$.

| PARAMETER | TEST CONDITIONS | | 12 V | | | 15 V | | | UNIT |
|--|--|----------|------|-----|-----|------|-----|-----|------|
| | | | MIN | TYP | MAX | MIN | TYP | MAX | |
| Short-circuit current | See ⁽¹⁾ , $T_J = 25^\circ\text{C}$ | | 1.6 | 1.9 | | 1.6 | 1.9 | | A |
| Maximum line transient | $R_{OUT} = 100\text{ }\Omega$, $T \leq 100\text{ ms}$ | LM2940-N | 60 | 75 | | | | | V |
| | $R_{OUT} = 100\text{ }\Omega$, $T \leq 100\text{ ms}$ $T_J = 25^\circ\text{C}$ | LM2940C | 45 | 55 | | 45 | 55 | | |
| Reverse polarity DC input voltage | $R_{OUT} = 100\text{ }\Omega$ | LM2940-N | -15 | -30 | | | | | V |
| | $R_{OUT} = 100\text{ }\Omega$ $T_J = 25^\circ\text{C}$ | LM2940C | -15 | -30 | | -15 | -30 | | |
| Reverse polarity transient input voltage | $R_{OUT} = 100\text{ }\Omega$, $T \leq 100\text{ ms}$ | LM2940-N | -50 | -75 | | | | | V |
| | $R_{OUT} = 100\text{ }\Omega$, $T \leq 1\text{ ms}$ | LM2940C | -45 | -55 | | -45 | -55 | | |

(1) Output current will decrease with increasing temperature but will not drop below 1 A at the maximum specified temperature.

6.8 Typical Characteristics

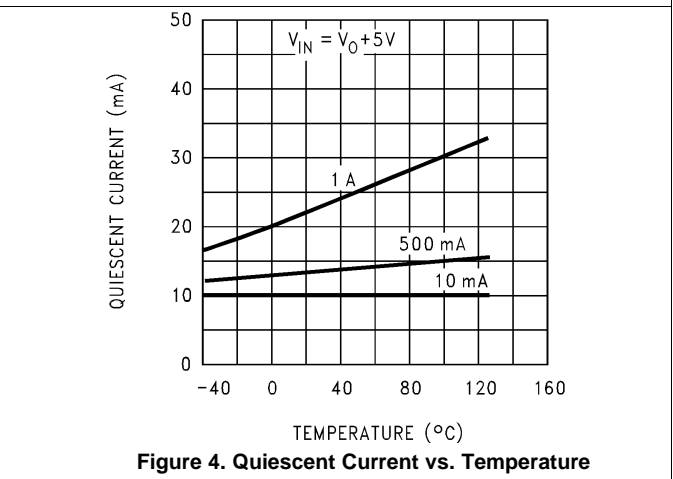
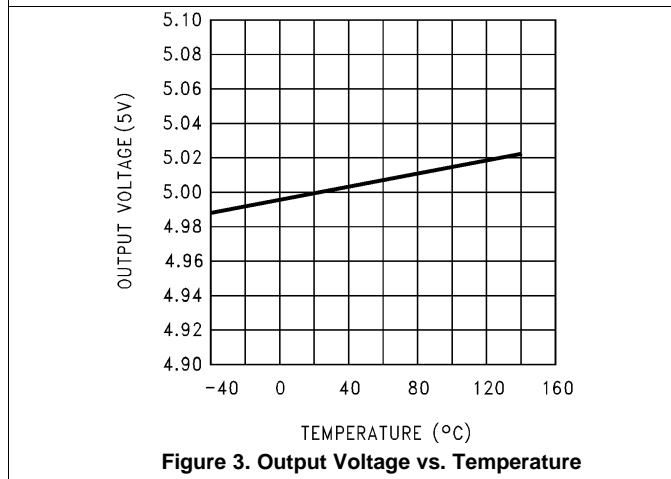
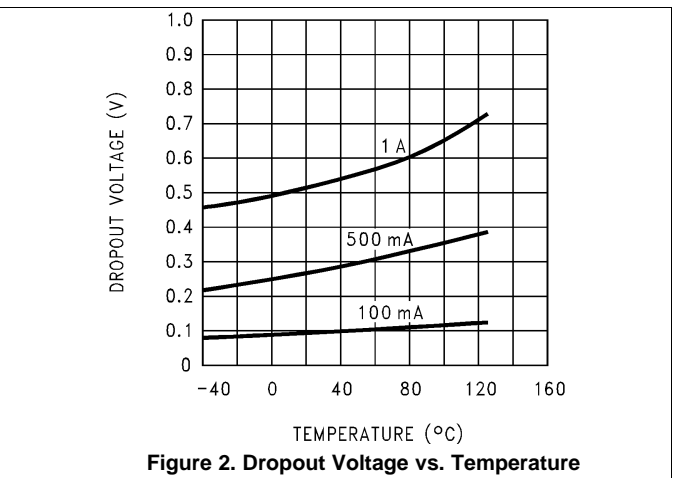
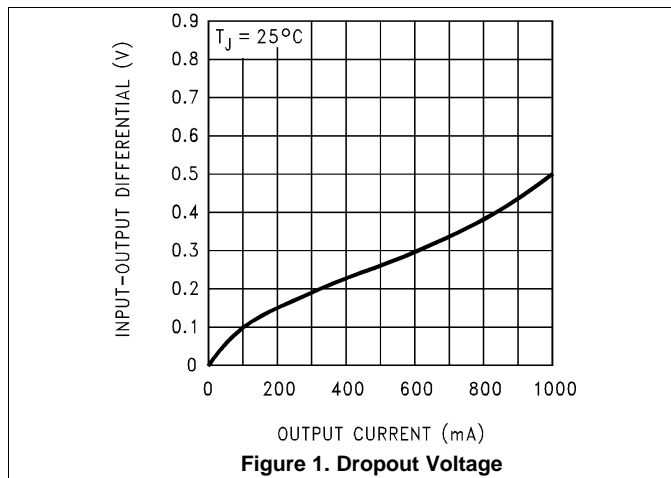

Typical Characteristics (continued)

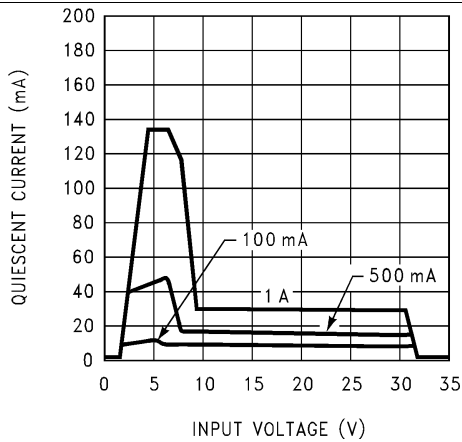

Figure 5. Quiescent Current

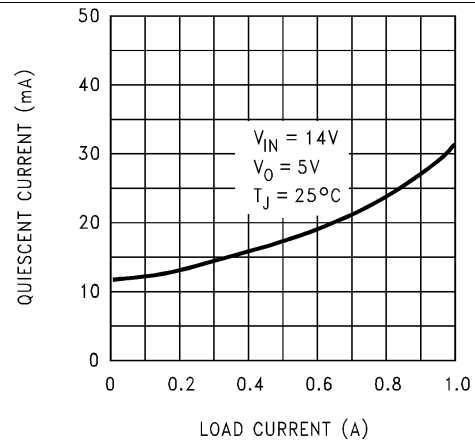

Figure 6. Quiescent Current

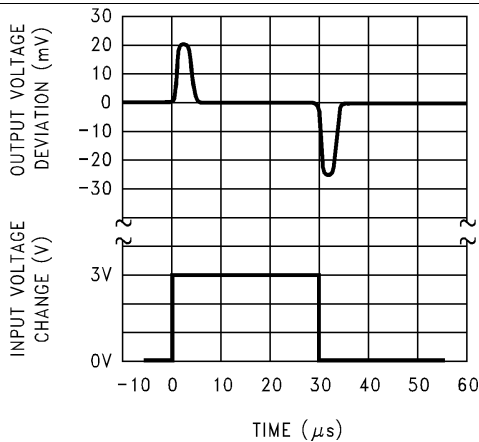

Figure 7. Line Transient Response

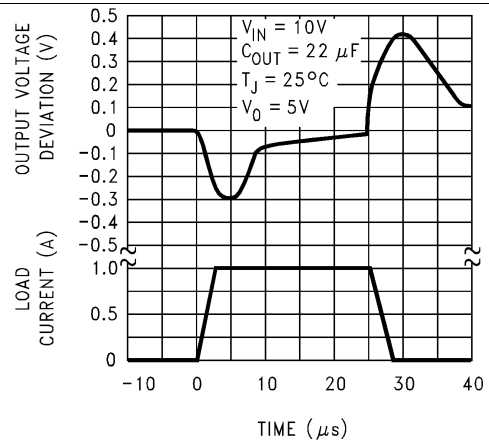

Figure 8. Load Transient Response

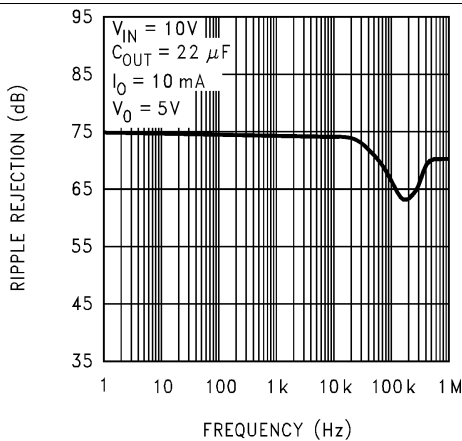

Figure 9. Ripple Rejection

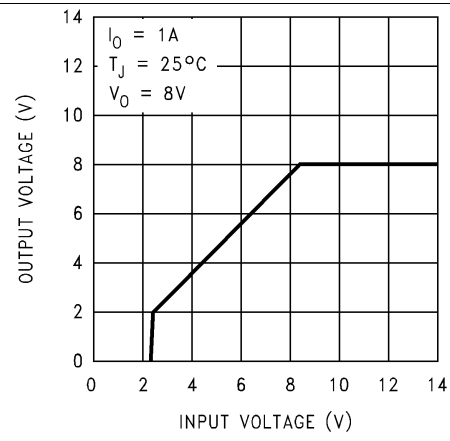

Figure 10. Low Voltage Behavior

Typical Characteristics (continued)

Figure 11. Low Voltage Behavior

Figure 12. Low Voltage Behavior

Figure 13. Low Voltage Behavior

Figure 14. Low Voltage Behavior

Figure 15. Output at Voltage Extremes

Figure 16. Output at Voltage Extremes

Typical Characteristics (continued)

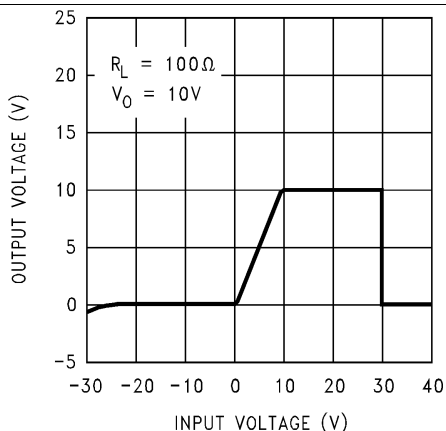

Figure 17. Output at Voltage Extremes

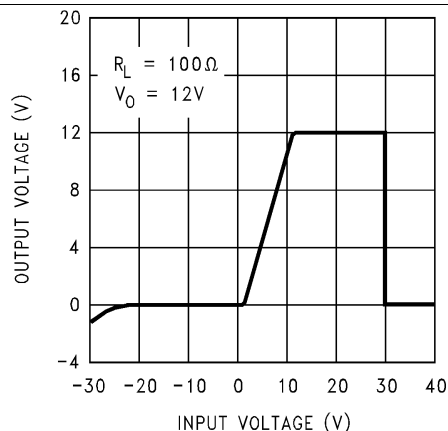

Figure 18. Output at Voltage Extremes

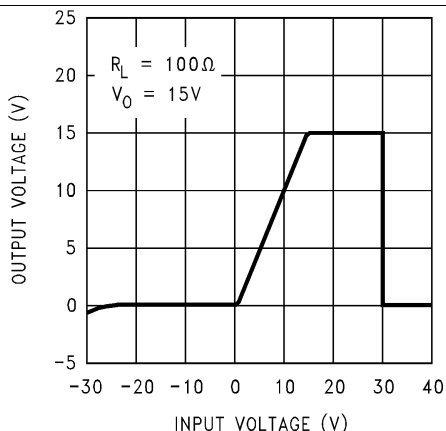

Figure 19. Output at Voltage Extremes

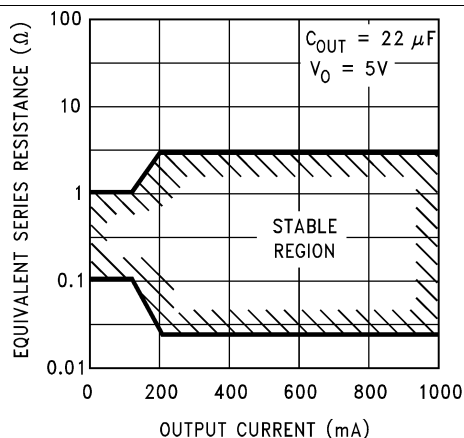

Figure 20. Output Capacitor ESR

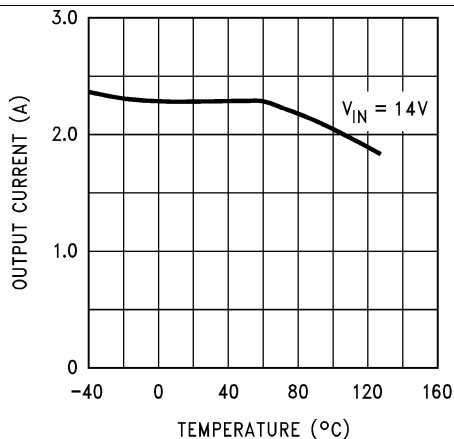

Figure 21. Peak Output Current

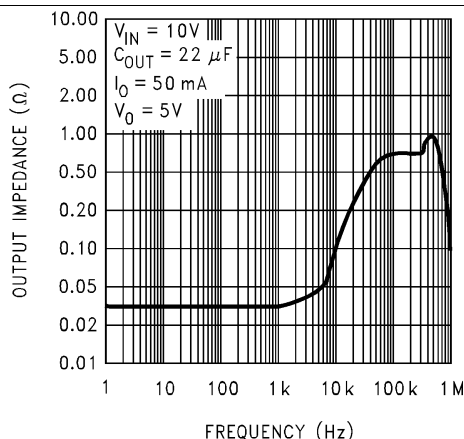

Figure 22. Output Impedance

Typical Characteristics (continued)

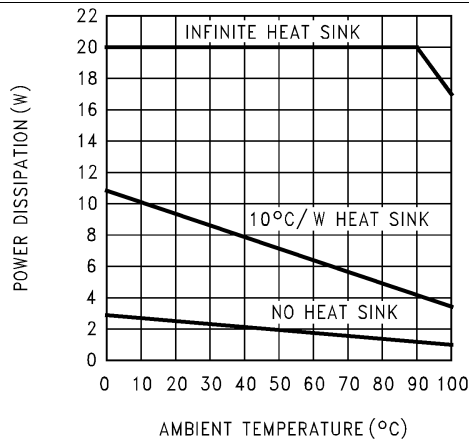

Figure 23. Maximum Power Dissipation (TO-220)

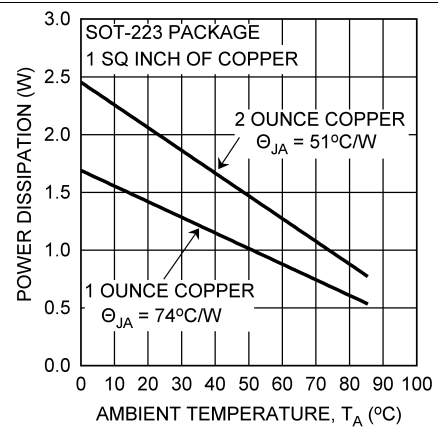

Figure 24. Maximum Power Dissipation (SOT-223)

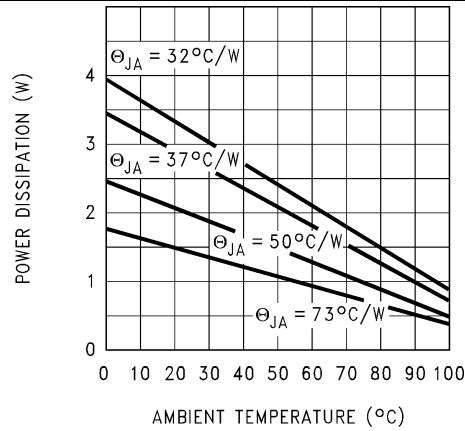

Figure 25. Maximum Power Dissipation (DDPAK/TO-263)

7 Detailed Description

7.1 Overview

The LM2940 positive voltage regulator features the ability to source 1 A of output current with a dropout voltage of typically 0.5 V and a maximum of 1 V over the entire temperature range. Furthermore, a quiescent current reduction circuit has been included which reduces the ground current when the differential between the input voltage and the output voltage exceeds approximately 3 V. The quiescent current with 1 A of output current and an input-output differential of 5 V is therefore only 30 mA. Higher quiescent currents only exist when the regulator is in the dropout mode ($V_{IN} - V_{OUT} \leq 3$ V).

7.2 Functional Block Diagram

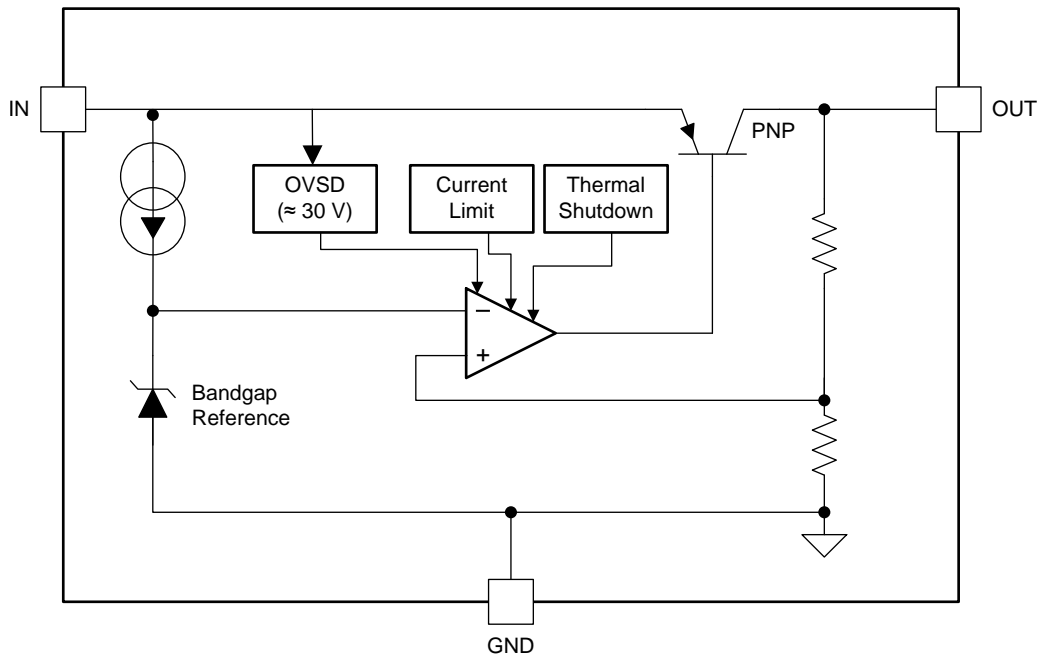

7.3 Feature Description

7.3.1 Short-Circuit Current Limit

The internal current limit circuit is used to protect the LDO against high-load current faults or shorting events. The LDO is not designed to operate in a steady-state current limit. During a current-limit event, the LDO sources constant current. Therefore, the output voltage falls when load impedance decreases. Note, also, that if a current limit occurs and the resulting output voltage is low, excessive power may be dissipated across the LDO, resulting a thermal shutdown of the output.

7.3.2 Overvoltage Shutdown (OVSD)

Input voltage greater than typically 30 V will cause the LM2940 output to be disabled. When operating with the input voltage greater than the maximum recommended input voltage of 26 V, the device performance is not ensured. Continuous operation with the input voltage greater than the maximum recommended input voltage is discouraged.

7.3.3 Thermal Shutdown (TSD)

The LM2940 contains the thermal shutdown circuitry to turn off the output when excessive heat is dissipated in the LDO. The internal protection circuitry of the LM2940 is designed to protect against thermal overload conditions. The TSD circuitry is not intended to replace proper heat sinking. Continuously running the device into thermal shutdown degrades its reliability as the junction temperature will be exceeding the absolute maximum junction temperature rating.

7.4 Device Functional Modes

7.4.1 Operation with Enable Control

The LM2940 design does not include any undervoltage lockout (UVLO), or enable functions. Generally, the output voltage will track the input voltage until the input voltage is greater than $V_{OUT} + 1V$. When the input voltage is greater than $V_{OUT} + 1V$, the LM2940 will be in linear operation, and the output voltage will be regulated. However, the device will be sensitive to any small perturbation of the input voltage. Device dynamic performance is improved when the input voltage is at least 2 V greater than the output voltage.

8 Application and Implementation

NOTE

Information in the following applications sections is not part of the TI component specification, and TI does not warrant its accuracy or completeness. TI's customers are responsible for determining suitability of components for their purposes. Customers should validate and test their design implementation to confirm system functionality.

8.1 Application Information

The LM2940-N and LM2940C positive voltage regulators feature the ability to source 1 A of output current with a dropout voltage of typically 0.5 V and a maximum of 1 V over the entire temperature range. The output capacitor, C_{OUT} , must have a capacitance value of at least 22 μF with an ESR of at least 100 m Ω , but no more than 1 Ω . The minimum capacitance value and the ESR requirements apply across the entire expected operating ambient temperature range.

8.2 Typical Application

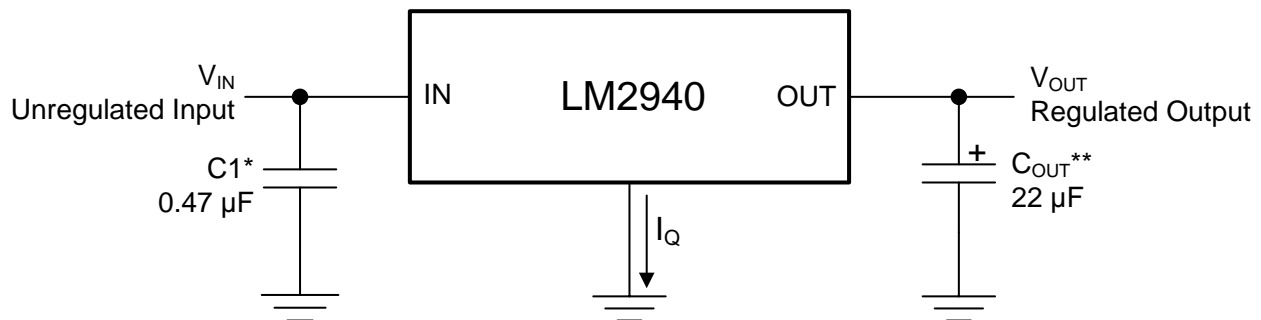

*Required if regulator is located far from power supply filter.

** C_{OUT} must be at least 22 μF to maintain stability. May be increased without bound to maintain regulation during transients. Locate as close as possible to the regulator. This capacitor must be rated over the same operating temperature range as the regulator and the ESR is critical; see curve.

Figure 26. Typical Application

8.2.1 Design Requirements

Table 1. Design Parameters

| DESIGN PARAMETER | EXAMPLE VALUE |
|----------------------------|------------------------------|
| Input voltage range | 6 V to 26 V |
| Output voltage range | 8 V |
| Output current range | 5 mA to 1 A |
| Input capacitor value | 0.47 μF |
| Output capacitor value | 22 μF minimum |
| Output capacitor ESR range | 100 m Ω to 1 Ω |

8.2.2 Detailed Design Procedure

8.2.2.1 External Capacitors

The output capacitor is critical to maintaining regulator stability, and must meet the required conditions for both equivalent series resistance (ESR) and minimum amount of capacitance.

8.2.2.1.1 Minimum Capacitance

The minimum output capacitance required to maintain stability is 22 μF (this value may be increased without limit). Larger values of output capacitance will give improved transient response.

8.2.2.1.2 ESR Limits

The ESR of the output capacitor will cause loop instability if it is too high or too low. The acceptable range of ESR plotted versus load current is shown in the graph below. *It is essential that the output capacitor meet these requirements, or oscillations can result.*

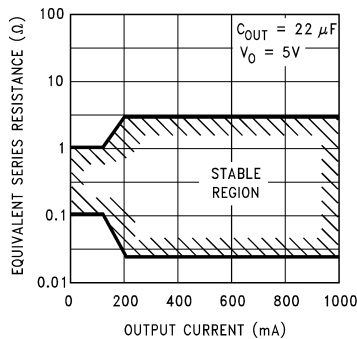

Figure 27. Output Capacitor ESR Limits

It is important to note that for most capacitors, ESR is specified only at room temperature. However, the designer must ensure that the ESR will stay inside the limits shown over the entire operating temperature range for the design.

For aluminum electrolytic capacitors, ESR will increase by about 30X as the temperature is reduced from 25°C to -40°C. This type of capacitor is not well-suited for low temperature operation.

Solid tantalum capacitors have a more stable ESR over temperature, but are more expensive than aluminum electrolytics. A cost-effective approach sometimes used is to parallel an aluminum electrolytic with a solid tantalum, with the total capacitance split about 75/25% with the aluminum being the larger value.

If two capacitors are paralleled, the effective ESR is the parallel of the two individual values. The flatter ESR of the tantalum will keep the effective ESR from rising as quickly at low temperatures.

8.2.3 Application Curves

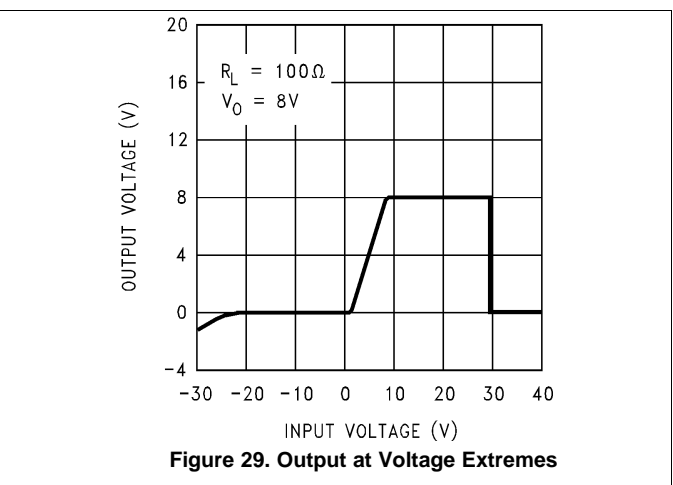
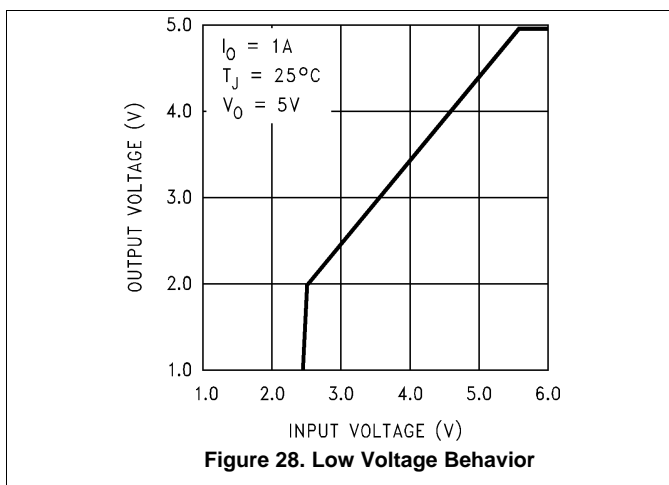

9 Power Supply Recommendations

The device is designed to operate from an input voltage supply range between $V_{OUT} + 1\text{ V}$ up to a maximum of 26 V. This input supply must be well regulated and free of spurious noise. To ensure that the LM2940 output voltage is well regulated, the input supply should be at least $V_{OUT} + 2\text{ V}$.

10 Layout

10.1 Layout Guidelines

The dynamic performance of the LM2940 is dependent on the layout of the PCB. PCB layout practices that are adequate for typical LDOs may degrade the PSRR, noise, or transient performance of the LM2940. Best performance is achieved by placing C_{IN} and C_{OUT} on the same side of the PCB as the LM2940, and as close as is practical to the package. The ground connections for C_{IN} and C_{OUT} should be back to the LM2940 ground pin using as wide and short of a copper trace as is practical.

10.2 Layout Examples

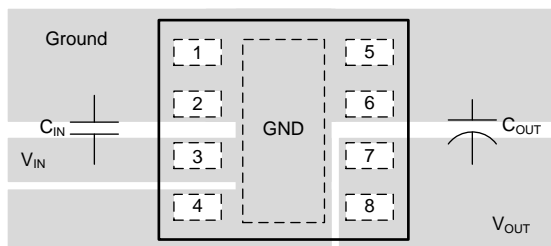

Figure 30. LM2940 WSON Layout

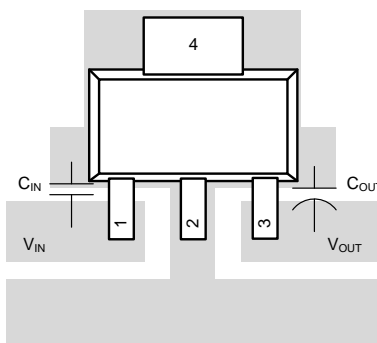

Figure 31. LM2940 SOT-223 Layout

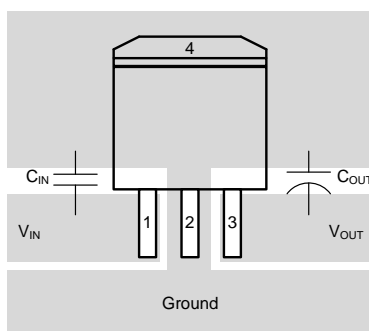

Figure 32. TO-263 Layout

10.3 Heatsinking

A heatsink may be required depending on the maximum power dissipation and maximum ambient temperature of the application. Under all possible operating conditions, the junction temperature must be within the range specified under [Absolute Maximum Ratings](#)⁽¹⁾⁽²⁾.

To determine if a heatsink is required, the power dissipated by the regulator, P_D , must be calculated.

Figure 33 shows the voltages and currents which are present in the circuit, as well as the formula for calculating the power dissipated in the regulator:

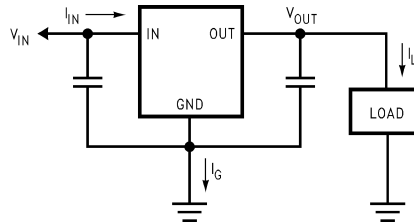

$$I_{IN} = I_L + I_G$$

$$P_D = (V_{IN} - V_{OUT}) I_L + (V_{IN}) I_G$$

Figure 33. Power Dissipation Diagram

The next parameter which must be calculated is the maximum allowable temperature rise, $T_{R(MAX)}$. This is calculated by using the formula:

$$T_{R(MAX)} = T_{J(MAX)} - T_{A(MAX)}$$

where

- $T_{J(MAX)}$ is the maximum allowable junction temperature, which is 125°C for commercial grade parts.
- $T_{A(MAX)}$ is the maximum ambient temperature which will be encountered in the application. (1)

Using the calculated values for $T_{R(MAX)}$ and P_D , the maximum allowable value for the junction-to-ambient thermal resistance, $R_{\theta JA}$, can now be found:

$$R_{\theta JA} = T_{R(MAX)} / P_D \quad (2)$$

NOTE

If the maximum allowable value for $R_{\theta JA}$ is found to be $\geq 23.3^\circ\text{C/W}$ for the TO-220 package (with a heatsink of 21.7°C/W $R_{\theta SA}$), $\geq 40.9^\circ\text{C/W}$ for the DPAK/TO-263 package, or $\geq 59.3^\circ\text{C/W}$ for the SOT-223 package, no heatsink is needed since the package alone will dissipate enough heat to satisfy these requirements.

If the calculated value for $R_{\theta JA}$ falls below these limits, a heatsink is required.

- (1) Absolute Maximum Ratings are limits beyond which damage to the device may occur. [Recommended Operating Conditions](#) are conditions under which the device functions but the specifications might not be ensured. For ensured specifications and test conditions see the [Electrical Characteristics \(5 V and 8 V\)](#).
- (2) If Military/Aerospace specified devices are required, please contact the Texas Instruments Sales Office/ Distributors for availability and specifications.

Heatsinking (continued)

10.3.1 Heatsinking TO-220 Package Parts

The TO-220 can be attached to a typical heatsink, or secured to a copper plane on a PC board.

If a manufactured heatsink is to be selected, the value of heatsink-to-ambient thermal resistance, $R_{\theta SA}$, must first be calculated:

$$R_{\theta SA} = R_{\theta JA} - R_{\theta CS} - R_{\theta JC}$$

where

- $R_{\theta JC}$ is defined as the thermal resistance from the junction to the surface of the case. A value of 3°C/W can be assumed for $R_{\theta JC}$ for this calculation.
- $R_{\theta CS}$ is defined as the thermal resistance between the case and the surface of the heatsink. The value of $R_{\theta CS}$ will vary from about 0.5°C/W to about 2.5°C/W (depending on method of attachment, insulator, etc.). If the exact value is unknown, 2°C/W should be assumed for $R_{\theta CS}$. (3)

When a value for $R_{\theta SA}$ is found using [Equation 3](#), a heatsink must be selected that has a value that is less than or equal to this number.

$R_{\theta SA}$ is specified numerically by the heatsink manufacturer in the catalog, or shown in a curve that plots temperature rise vs power dissipation for the heatsink.

11 Device and Documentation Support

11.1 Documentation Support

11.1.1 Related Documentation

For related documentation see the following:

- Application Note AN-1028 *Maximum Power Enhancement Techniques for Power Packages* ([SNVA036](#)).
- Application Note AN-1187 *Leadless Leadframe Package (LLP)* ([SNOA401](#)).

11.2 Related Links

The table below lists quick access links. Categories include technical documents, support and community resources, tools and software, and quick access to sample or buy.

Table 2. Related Links

| PARTS | PRODUCT FOLDER | SAMPLE & BUY | TECHNICAL DOCUMENTS | TOOLS & SOFTWARE | SUPPORT & COMMUNITY |
|----------|----------------------------|----------------------------|----------------------------|----------------------------|----------------------------|
| LM2940-N | Click here | Click here | Click here | Click here | Click here |
| LM2940C | Click here | Click here | Click here | Click here | Click here |

11.3 Trademarks

All trademarks are the property of their respective owners.

11.4 Electrostatic Discharge Caution



These devices have limited built-in ESD protection. The leads should be shorted together or the device placed in conductive foam during storage or handling to prevent electrostatic damage to the MOS gates.

11.5 Glossary

[SLYZ022](#) — *TI Glossary*.

This glossary lists and explains terms, acronyms, and definitions.

12 Mechanical, Packaging, and Orderable Information

The following pages include mechanical, packaging, and orderable information. This information is the most current data available for the designated devices. This data is subject to change without notice and revision of this document. For browser-based versions of this data sheet, refer to the left-hand navigation.

PACKAGING INFORMATION

| Orderable Device | Status (1) | Package Type | Package Drawing | Pins | Package Qty | Eco Plan (2) | Lead/Ball Finish (6) | MSL Peak Temp (3) | Op Temp (°C) | Device Marking (4/5) | Samples |
|--------------------|---------------|------------------|--------------------|------|----------------|----------------------------|-------------------------|----------------------|--------------|-------------------------|-------------------------|
| LM2940C-12 MWC | ACTIVE | WAFERSALE | YS | 0 | 1 | Green (RoHS & no Sb/Br) | Call TI | Level-1-NA-UNLIM | | | Samples |
| LM2940CS-12 | NRND | DDPAK/ TO-263 | KTT | 3 | 45 | TBD | Call TI | Call TI | 0 to 125 | LM2940CS -12 P+ | |
| LM2940CS-12/NOPB | ACTIVE | DDPAK/ TO-263 | KTT | 3 | 45 | Pb-Free (RoHS Exempt) | CU SN | Level-3-245C-168 HR | 0 to 125 | LM2940CS -12 P+ | Samples |
| LM2940CS-15 | NRND | DDPAK/ TO-263 | KTT | 3 | 45 | TBD | Call TI | Call TI | 0 to 125 | LM2940CS -15 P+ | |
| LM2940CS-15/NOPB | ACTIVE | DDPAK/ TO-263 | KTT | 3 | 45 | Pb-Free (RoHS Exempt) | CU SN | Level-3-245C-168 HR | 0 to 125 | LM2940CS -15 P+ | Samples |
| LM2940CS-5.0 | NRND | DDPAK/ TO-263 | KTT | 3 | 45 | TBD | Call TI | Call TI | 0 to 125 | LM2940CS -5.0 P+ | |
| LM2940CS-5.0/NOPB | ACTIVE | DDPAK/ TO-263 | KTT | 3 | 45 | Pb-Free (RoHS Exempt) | CU SN | Level-3-245C-168 HR | 0 to 125 | LM2940CS -5.0 P+ | Samples |
| LM2940CS-9.0/NOPB | ACTIVE | DDPAK/ TO-263 | KTT | 3 | 45 | Pb-Free (RoHS Exempt) | CU SN | Level-3-245C-168 HR | 0 to 125 | LM2940CS -9.0 P+ | Samples |
| LM2940CSX-12 | NRND | DDPAK/ TO-263 | KTT | 3 | 500 | TBD | Call TI | Call TI | 0 to 125 | LM2940CS -12 P+ | |
| LM2940CSX-12/NOPB | ACTIVE | DDPAK/ TO-263 | KTT | 3 | 500 | Pb-Free (RoHS Exempt) | CU SN | Level-3-245C-168 HR | 0 to 125 | LM2940CS -12 P+ | Samples |
| LM2940CSX-15 | NRND | DDPAK/ TO-263 | KTT | 3 | | TBD | Call TI | Call TI | 0 to 125 | LM2940CS -15 P+ | |
| LM2940CSX-15/NOPB | ACTIVE | DDPAK/ TO-263 | KTT | 3 | 500 | Pb-Free (RoHS Exempt) | CU SN | Level-3-245C-168 HR | 0 to 125 | LM2940CS -15 P+ | Samples |
| LM2940CSX-5.0 | NRND | DDPAK/ TO-263 | KTT | 3 | 500 | TBD | Call TI | Call TI | 0 to 125 | LM2940CS -5.0 P+ | |
| LM2940CSX-5.0/NOPB | ACTIVE | DDPAK/ TO-263 | KTT | 3 | 500 | Pb-Free (RoHS Exempt) | CU SN | Level-3-245C-168 HR | 0 to 125 | LM2940CS -5.0 P+ | Samples |
| LM2940CSX-9.0/NOPB | ACTIVE | DDPAK/ TO-263 | KTT | 3 | 500 | Pb-Free (RoHS Exempt) | CU SN | Level-3-245C-168 HR | 0 to 125 | LM2940CS -9.0 P+ | Samples |
| LM2940CT-12 | NRND | TO-220 | NDE | 3 | 45 | TBD | Call TI | Call TI | 0 to 125 | LM2940CT -12 P+ | |
| LM2940CT-12/NOPB | ACTIVE | TO-220 | NDE | 3 | 45 | Green (RoHS & no Sb/Br) | CU SN | Level-1-NA-UNLIM | 0 to 125 | LM2940CT -12 P+ | Samples |

| Orderable Device | Status (1) | Package Type | Package Drawing | Pins | Package Qty | Eco Plan (2) | Lead/Ball Finish (6) | MSL Peak Temp (3) | Op Temp (°C) | Device Marking (4/5) | Samples |
|---------------------|---------------|--------------|--------------------|------|----------------|----------------------------|-------------------------|----------------------|--------------|-------------------------|-------------------------|
| LM2940CT-15 | NRND | TO-220 | NDE | 3 | 45 | TBD | Call TI | Call TI | 0 to 125 | LM2940CT -15 P+ | |
| LM2940CT-15/NOPB | ACTIVE | TO-220 | NDE | 3 | 45 | Green (RoHS & no Sb/Br) | CU SN | Level-1-NA-UNLIM | 0 to 125 | LM2940CT -15 P+ | Samples |
| LM2940CT-5.0 | NRND | TO-220 | NDE | 3 | 45 | TBD | Call TI | Call TI | 0 to 125 | LM2940CT -5.0 P+ | |
| LM2940CT-5.0/LF01 | ACTIVE | TO-220 | NDG | 3 | 45 | Pb-Free (RoHS Exempt) | CU SN | Level-3-245C-168 HR | | LM2940CT -5.0 P+ | Samples |
| LM2940CT-5.0/NOPB | ACTIVE | TO-220 | NDE | 3 | 45 | Green (RoHS & no Sb/Br) | CU SN | Level-1-NA-UNLIM | 0 to 125 | LM2940CT -5.0 P+ | Samples |
| LM2940CT-9.0/NOPB | ACTIVE | TO-220 | NDE | 3 | 45 | Green (RoHS & no Sb/Br) | CU SN | Level-1-NA-UNLIM | 0 to 125 | LM2940CT -9.0 P+ | Samples |
| LM2940IMP-10 | NRND | SOT-223 | DCY | 4 | | TBD | Call TI | Call TI | -40 to 85 | L55B | |
| LM2940IMP-10/NOPB | ACTIVE | SOT-223 | DCY | 4 | 1000 | Green (RoHS & no Sb/Br) | CU SN | Level-1-260C-UNLIM | -40 to 85 | L55B | Samples |
| LM2940IMP-12 | NRND | SOT-223 | DCY | 4 | 1000 | TBD | Call TI | Call TI | -40 to 85 | L56B | |
| LM2940IMP-12/NOPB | ACTIVE | SOT-223 | DCY | 4 | 1000 | Green (RoHS & no Sb/Br) | CU SN | Level-1-260C-UNLIM | -40 to 85 | L56B | Samples |
| LM2940IMP-15 | NRND | SOT-223 | DCY | 4 | 1000 | TBD | Call TI | Call TI | -40 to 85 | L70B | |
| LM2940IMP-15/NOPB | ACTIVE | SOT-223 | DCY | 4 | 1000 | Green (RoHS & no Sb/Br) | CU SN | Level-1-260C-UNLIM | -40 to 85 | L70B | Samples |
| LM2940IMP-5.0 | NRND | SOT-223 | DCY | 4 | 1000 | TBD | Call TI | Call TI | -40 to 85 | L53B | |
| LM2940IMP-5.0/NOPB | ACTIVE | SOT-223 | DCY | 4 | 1000 | Green (RoHS & no Sb/Br) | CU SN | Level-1-260C-UNLIM | -40 to 85 | L53B | Samples |
| LM2940IMP-9.0/NOPB | ACTIVE | SOT-223 | DCY | 4 | 1000 | Green (RoHS & no Sb/Br) | CU SN | Level-1-260C-UNLIM | -40 to 85 | L0EB | Samples |
| LM2940IMPX-10/NOPB | ACTIVE | SOT-223 | DCY | 4 | 2000 | Green (RoHS & no Sb/Br) | CU SN | Level-1-260C-UNLIM | -40 to 85 | L55B | Samples |
| LM2940IMPX-12/NOPB | ACTIVE | SOT-223 | DCY | 4 | 2000 | Green (RoHS & no Sb/Br) | CU SN | Level-1-260C-UNLIM | -40 to 85 | L56B | Samples |
| LM2940IMPX-5.0/NOPB | ACTIVE | SOT-223 | DCY | 4 | 2000 | Green (RoHS & no Sb/Br) | CU SN | Level-1-260C-UNLIM | -40 to 85 | L53B | Samples |
| LM2940IMPX-8.0/NOPB | ACTIVE | SOT-223 | DCY | 4 | 2000 | Green (RoHS & no Sb/Br) | CU SN | Level-1-260C-UNLIM | -40 to 85 | L54B | Samples |
| LM2940LD-12 | NRND | WSO | NGN | 8 | 1000 | TBD | Call TI | Call TI | -40 to 125 | L00018B | |

| Orderable Device | Status (1) | Package Type | Package Drawing | Pins | Package Qty | Eco Plan (2) | Lead/Ball Finish (6) | MSL Peak Temp (3) | Op Temp (°C) | Device Marking (4/5) | Samples |
|-------------------|---------------|------------------|-----------------|------|-------------|-------------------------|-------------------------|----------------------|--------------|-------------------------|-------------------------|
| LM2940LD-12/NOPB | ACTIVE | WSON | NGN | 8 | 1000 | Green (RoHS & no Sb/Br) | CU SN | Level-3-260C-168 HR | -40 to 125 | L00018B | Samples |
| LM2940LD-5.0 | NRND | WSON | NGN | 8 | | TBD | Call TI | Call TI | -40 to 125 | L00014B | |
| LM2940LD-5.0/NOPB | ACTIVE | WSON | NGN | 8 | 1000 | Green (RoHS & no Sb/Br) | CU SN | Level-3-260C-168 HR | -40 to 125 | L00014B | Samples |
| LM2940S-10 | NRND | DDPAK/ TO-263 | KTT | 3 | 45 | TBD | Call TI | Call TI | -40 to 125 | LM2940S -10 P+ | |
| LM2940S-10/NOPB | ACTIVE | DDPAK/ TO-263 | KTT | 3 | 45 | Pb-Free (RoHS Exempt) | CU SN | Level-3-245C-168 HR | -40 to 125 | LM2940S -10 P+ | Samples |
| LM2940S-12 | NRND | DDPAK/ TO-263 | KTT | 3 | 45 | TBD | Call TI | Call TI | -40 to 125 | LM2940S -12 P+ | |
| LM2940S-12/NOPB | ACTIVE | DDPAK/ TO-263 | KTT | 3 | 45 | Pb-Free (RoHS Exempt) | CU SN | Level-3-245C-168 HR | -40 to 125 | LM2940S -12 P+ | Samples |
| LM2940S-5.0 | NRND | DDPAK/ TO-263 | KTT | 3 | 45 | TBD | Call TI | Call TI | -40 to 125 | LM2940S -5.0 P+ | |
| LM2940S-5.0/NOPB | ACTIVE | DDPAK/ TO-263 | KTT | 3 | 45 | Pb-Free (RoHS Exempt) | CU SN | Level-3-245C-168 HR | -40 to 125 | LM2940S -5.0 P+ | Samples |
| LM2940S-8.0/NOPB | ACTIVE | DDPAK/ TO-263 | KTT | 3 | 45 | Pb-Free (RoHS Exempt) | CU SN | Level-3-245C-168 HR | -40 to 125 | LM2940S -8.0 P+ | Samples |
| LM2940S-9.0/NOPB | ACTIVE | DDPAK/ TO-263 | KTT | 3 | 45 | Pb-Free (RoHS Exempt) | CU SN | Level-3-245C-168 HR | -40 to 125 | LM2940S -9.0 P+ | Samples |
| LM2940SX-10 | NRND | DDPAK/ TO-263 | KTT | 3 | 500 | TBD | Call TI | Call TI | -40 to 125 | LM2940S -10 P+ | |
| LM2940SX-10/NOPB | ACTIVE | DDPAK/ TO-263 | KTT | 3 | 500 | Pb-Free (RoHS Exempt) | CU SN | Level-3-245C-168 HR | -40 to 125 | LM2940S -10 P+ | Samples |
| LM2940SX-12 | NRND | DDPAK/ TO-263 | KTT | 3 | 500 | TBD | Call TI | Call TI | -40 to 125 | LM2940S -12 P+ | |
| LM2940SX-12/NOPB | ACTIVE | DDPAK/ TO-263 | KTT | 3 | 500 | Pb-Free (RoHS Exempt) | CU SN | Level-3-245C-168 HR | -40 to 125 | LM2940S -12 P+ | Samples |
| LM2940SX-5.0 | NRND | DDPAK/ TO-263 | KTT | 3 | 500 | TBD | Call TI | Call TI | -40 to 125 | LM2940S -5.0 P+ | |
| LM2940SX-5.0/NOPB | ACTIVE | DDPAK/ TO-263 | KTT | 3 | 500 | Pb-Free (RoHS Exempt) | CU SN | Level-3-245C-168 HR | -40 to 125 | LM2940S -5.0 P+ | Samples |
| LM2940SX-8.0/NOPB | ACTIVE | DDPAK/ TO-263 | KTT | 3 | 500 | Pb-Free (RoHS Exempt) | CU SN | Level-3-245C-168 HR | -40 to 125 | LM2940S -8.0 P+ | Samples |

| Orderable Device | Status (1) | Package Type | Package Drawing | Pins | Package Qty | Eco Plan (2) | Lead/Ball Finish (6) | MSL Peak Temp (3) | Op Temp (°C) | Device Marking (4/5) | Samples |
|-------------------|---------------|------------------|-----------------|------|-------------|----------------------------|-------------------------|----------------------|--------------|-------------------------|-------------------------|
| LM2940SX-9.0/NOPB | ACTIVE | DDPAK/ TO-263 | KTT | 3 | 500 | Pb-Free (RoHS Exempt) | CU SN | Level-3-245C-168 HR | -40 to 125 | LM2940S -9.0 P+ | Samples |
| LM2940T-10.0 | NRND | TO-220 | NDE | 3 | 45 | TBD | Call TI | Call TI | -40 to 125 | LM2940T 10.0 P+ | |
| LM2940T-10.0/NOPB | ACTIVE | TO-220 | NDE | 3 | 45 | Green (RoHS & no Sb/Br) | CU SN | Level-1-NA-UNLIM | -40 to 125 | LM2940T 10.0 P+ | Samples |
| LM2940T-12.0 | NRND | TO-220 | NDE | 3 | 45 | TBD | Call TI | Call TI | -40 to 125 | LM2940T 12.0 P+ | |
| LM2940T-12.0/NOPB | ACTIVE | TO-220 | NDE | 3 | 45 | Green (RoHS & no Sb/Br) | CU SN | Level-1-NA-UNLIM | -40 to 125 | LM2940T 12.0 P+ | Samples |
| LM2940T-5.0 | NRND | TO-220 | NDE | 3 | 45 | TBD | Call TI | Call TI | -40 to 125 | LM2940T -5.0 P+ | |
| LM2940T-5.0/LF08 | ACTIVE | TO-220 | NEB | 3 | 45 | Green (RoHS & no Sb/Br) | CU SN | Level-3-245C-168 HR | | LM2940T -5.0 P+ | Samples |
| LM2940T-5.0/NOPB | ACTIVE | TO-220 | NDE | 3 | 45 | Green (RoHS & no Sb/Br) | CU SN | Level-1-NA-UNLIM | -40 to 125 | LM2940T -5.0 P+ | Samples |
| LM2940T-8.0 | NRND | TO-220 | NDE | 3 | 45 | TBD | Call TI | Call TI | -40 to 125 | LM2940T -8.0 P+ | |
| LM2940T-8.0/NOPB | ACTIVE | TO-220 | NDE | 3 | 45 | Green (RoHS & no Sb/Br) | CU SN | Level-1-NA-UNLIM | -40 to 125 | LM2940T -8.0 P+ | Samples |
| LM2940T-9.0 | NRND | TO-220 | NDE | 3 | 45 | TBD | Call TI | Call TI | -40 to 125 | LM2940T -9.0 P+ | |
| LM2940T-9.0/NOPB | ACTIVE | TO-220 | NDE | 3 | 45 | Green (RoHS & no Sb/Br) | CU SN | Level-1-NA-UNLIM | -40 to 125 | LM2940T -9.0 P+ | Samples |

(1) The marketing status values are defined as follows:

ACTIVE: Product device recommended for new designs.

LIFEBUY: TI has announced that the device will be discontinued, and a lifetime-buy period is in effect.

NRND: Not recommended for new designs. Device is in production to support existing customers, but TI does not recommend using this part in a new design.

PREVIEW: Device has been announced but is not in production. Samples may or may not be available.

OBSOLETE: TI has discontinued the production of the device.

(2) Eco Plan - The planned eco-friendly classification: Pb-Free (RoHS), Pb-Free (RoHS Exempt), or Green (RoHS & no Sb/Br) - please check <http://www.ti.com/productcontent> for the latest availability information and additional product content details.

TBD: The Pb-Free/Green conversion plan has not been defined.

Pb-Free (RoHS): TI's terms "Lead-Free" or "Pb-Free" mean semiconductor products that are compatible with the current RoHS requirements for all 6 substances, including the requirement that lead not exceed 0.1% by weight in homogeneous materials. Where designed to be soldered at high temperatures, TI Pb-Free products are suitable for use in specified lead-free processes.

Pb-Free (RoHS Exempt): This component has a RoHS exemption for either 1) lead-based flip-chip solder bumps used between the die and package, or 2) lead-based die adhesive used between the die and leadframe. The component is otherwise considered Pb-Free (RoHS compatible) as defined above.

Green (RoHS & no Sb/Br): TI defines "Green" to mean Pb-Free (RoHS compatible), and free of Bromine (Br) and Antimony (Sb) based flame retardants (Br or Sb do not exceed 0.1% by weight in homogeneous material)

⁽³⁾ MSL, Peak Temp. - The Moisture Sensitivity Level rating according to the JEDEC industry standard classifications, and peak solder temperature.

⁽⁴⁾ There may be additional marking, which relates to the logo, the lot trace code information, or the environmental category on the device.

⁽⁵⁾ Multiple Device Markings will be inside parentheses. Only one Device Marking contained in parentheses and separated by a "~" will appear on a device. If a line is indented then it is a continuation of the previous line and the two combined represent the entire Device Marking for that device.

⁽⁶⁾ Lead/Ball Finish - Orderable Devices may have multiple material finish options. Finish options are separated by a vertical ruled line. Lead/Ball Finish values may wrap to two lines if the finish value exceeds the maximum column width.

Important Information and Disclaimer: The information provided on this page represents TI's knowledge and belief as of the date that it is provided. TI bases its knowledge and belief on information provided by third parties, and makes no representation or warranty as to the accuracy of such information. Efforts are underway to better integrate information from third parties. TI has taken and continues to take reasonable steps to provide representative and accurate information but may not have conducted destructive testing or chemical analysis on incoming materials and chemicals. TI and TI suppliers consider certain information to be proprietary, and thus CAS numbers and other limited information may not be available for release.

In no event shall TI's liability arising out of such information exceed the total purchase price of the TI part(s) at issue in this document sold by TI to Customer on an annual basis.

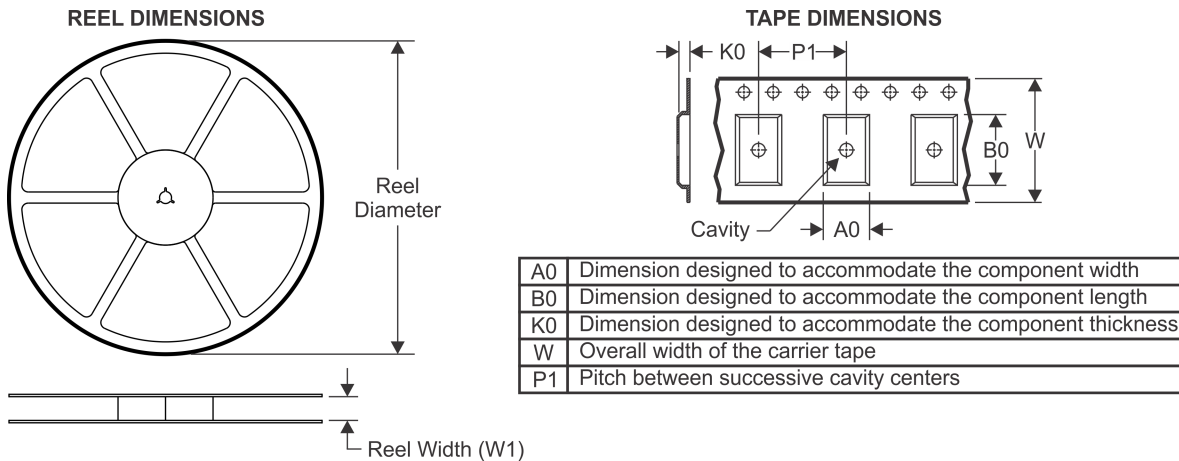
TAPE AND REEL INFORMATION

QUADRANT ASSIGNMENTS FOR PIN 1 ORIENTATION IN TAPE

*All dimensions are nominal

| Device | Package Type | Package Drawing | Pins | SPQ | Reel Diameter (mm) | Reel Width W1 (mm) | A0 (mm) | B0 (mm) | K0 (mm) | P1 (mm) | W (mm) | Pin1 Quadrant |
|--------------------|--------------|-----------------|------|------|--------------------|--------------------|---------|---------|---------|---------|--------|---------------|
| LM2940CSX-12 | DDPAK/TO-263 | KTT | 3 | 500 | 330.0 | 24.4 | 10.75 | 14.85 | 5.0 | 16.0 | 24.0 | Q2 |
| LM2940CSX-12/NOPB | DDPAK/TO-263 | KTT | 3 | 500 | 330.0 | 24.4 | 10.75 | 14.85 | 5.0 | 16.0 | 24.0 | Q2 |
| LM2940CSX-15/NOPB | DDPAK/TO-263 | KTT | 3 | 500 | 330.0 | 24.4 | 10.75 | 14.85 | 5.0 | 16.0 | 24.0 | Q2 |
| LM2940CSX-5.0 | DDPAK/TO-263 | KTT | 3 | 500 | 330.0 | 24.4 | 10.75 | 14.85 | 5.0 | 16.0 | 24.0 | Q2 |
| LM2940CSX-5.0/NOPB | DDPAK/TO-263 | KTT | 3 | 500 | 330.0 | 24.4 | 10.75 | 14.85 | 5.0 | 16.0 | 24.0 | Q2 |
| LM2940CSX-9.0/NOPB | DDPAK/TO-263 | KTT | 3 | 500 | 330.0 | 24.4 | 10.75 | 14.85 | 5.0 | 16.0 | 24.0 | Q2 |
| LM2940IMP-10/NOPB | SOT-223 | DCY | 4 | 1000 | 330.0 | 16.4 | 7.0 | 7.5 | 2.2 | 12.0 | 16.0 | Q3 |
| LM2940IMP-12 | SOT-223 | DCY | 4 | 1000 | 330.0 | 16.4 | 7.0 | 7.5 | 2.2 | 12.0 | 16.0 | Q3 |
| LM2940IMP-12/NOPB | SOT-223 | DCY | 4 | 1000 | 330.0 | 16.4 | 7.0 | 7.5 | 2.2 | 12.0 | 16.0 | Q3 |
| LM2940IMP-15 | SOT-223 | DCY | 4 | 1000 | 330.0 | 16.4 | 7.0 | 7.5 | 2.2 | 12.0 | 16.0 | Q3 |
| LM2940IMP-15/NOPB | SOT-223 | DCY | 4 | 1000 | 330.0 | 16.4 | 7.0 | 7.5 | 2.2 | 12.0 | 16.0 | Q3 |
| LM2940IMP-5.0 | SOT-223 | DCY | 4 | 1000 | 330.0 | 16.4 | 7.0 | 7.5 | 2.2 | 12.0 | 16.0 | Q3 |
| LM2940IMP-5.0/NOPB | SOT-223 | DCY | 4 | 1000 | 330.0 | 16.4 | 7.0 | 7.5 | 2.2 | 12.0 | 16.0 | Q3 |
| LM2940IMP-9.0/NOPB | SOT-223 | DCY | 4 | 1000 | 330.0 | 16.4 | 7.0 | 7.5 | 2.2 | 12.0 | 16.0 | Q3 |

| Device | Package Type | Package Drawing | Pins | SPQ | Reel Diameter (mm) | Reel Width W1 (mm) | A0 (mm) | B0 (mm) | K0 (mm) | P1 (mm) | W (mm) | Pin1 Quadrant |
|---------------------|------------------|-----------------|------|------|--------------------|--------------------|---------|---------|---------|---------|--------|---------------|
| LM2940IMPX-10/NOPB | SOT-223 | DCY | 4 | 2000 | 330.0 | 16.4 | 7.0 | 7.5 | 2.2 | 12.0 | 16.0 | Q3 |
| LM2940IMPX-12/NOPB | SOT-223 | DCY | 4 | 2000 | 330.0 | 16.4 | 7.0 | 7.5 | 2.2 | 12.0 | 16.0 | Q3 |
| LM2940IMPX-5.0/NOPB | SOT-223 | DCY | 4 | 2000 | 330.0 | 16.4 | 7.0 | 7.5 | 2.2 | 12.0 | 16.0 | Q3 |
| LM2940IMPX-8.0/NOPB | SOT-223 | DCY | 4 | 2000 | 330.0 | 16.4 | 7.0 | 7.5 | 2.2 | 12.0 | 16.0 | Q3 |
| LM2940LD-12 | WSON | NGN | 8 | 1000 | 178.0 | 12.4 | 4.3 | 4.3 | 1.3 | 8.0 | 12.0 | Q1 |
| LM2940LD-12/NOPB | WSON | NGN | 8 | 1000 | 178.0 | 12.4 | 4.3 | 4.3 | 1.3 | 8.0 | 12.0 | Q1 |
| LM2940LD-5.0/NOPB | WSON | NGN | 8 | 1000 | 178.0 | 12.4 | 4.3 | 4.3 | 1.3 | 8.0 | 12.0 | Q1 |
| LM2940SX-10 | DDPAK/ TO-263 | KTT | 3 | 500 | 330.0 | 24.4 | 10.75 | 14.85 | 5.0 | 16.0 | 24.0 | Q2 |
| LM2940SX-10/NOPB | DDPAK/ TO-263 | KTT | 3 | 500 | 330.0 | 24.4 | 10.75 | 14.85 | 5.0 | 16.0 | 24.0 | Q2 |
| LM2940SX-12 | DDPAK/ TO-263 | KTT | 3 | 500 | 330.0 | 24.4 | 10.75 | 14.85 | 5.0 | 16.0 | 24.0 | Q2 |
| LM2940SX-12/NOPB | DDPAK/ TO-263 | KTT | 3 | 500 | 330.0 | 24.4 | 10.75 | 14.85 | 5.0 | 16.0 | 24.0 | Q2 |
| LM2940SX-5.0 | DDPAK/ TO-263 | KTT | 3 | 500 | 330.0 | 24.4 | 10.75 | 14.85 | 5.0 | 16.0 | 24.0 | Q2 |
| LM2940SX-5.0/NOPB | DDPAK/ TO-263 | KTT | 3 | 500 | 330.0 | 24.4 | 10.75 | 14.85 | 5.0 | 16.0 | 24.0 | Q2 |
| LM2940SX-8.0/NOPB | DDPAK/ TO-263 | KTT | 3 | 500 | 330.0 | 24.4 | 10.75 | 14.85 | 5.0 | 16.0 | 24.0 | Q2 |
| LM2940SX-9.0/NOPB | DDPAK/ TO-263 | KTT | 3 | 500 | 330.0 | 24.4 | 10.75 | 14.85 | 5.0 | 16.0 | 24.0 | Q2 |

TAPE AND REEL BOX DIMENSIONS

*All dimensions are nominal

| Device | Package Type | Package Drawing | Pins | SPQ | Length (mm) | Width (mm) | Height (mm) |
|---------------------|--------------|-----------------|------|------|-------------|------------|-------------|
| LM2940CSX-12 | DDPAK/TO-263 | KTT | 3 | 500 | 367.0 | 367.0 | 45.0 |
| LM2940CSX-12/NOPB | DDPAK/TO-263 | KTT | 3 | 500 | 367.0 | 367.0 | 45.0 |
| LM2940CSX-15/NOPB | DDPAK/TO-263 | KTT | 3 | 500 | 367.0 | 367.0 | 45.0 |
| LM2940CSX-5.0 | DDPAK/TO-263 | KTT | 3 | 500 | 367.0 | 367.0 | 45.0 |
| LM2940CSX-5.0/NOPB | DDPAK/TO-263 | KTT | 3 | 500 | 367.0 | 367.0 | 45.0 |
| LM2940CSX-9.0/NOPB | DDPAK/TO-263 | KTT | 3 | 500 | 367.0 | 367.0 | 45.0 |
| LM2940IMP-10/NOPB | SOT-223 | DCY | 4 | 1000 | 367.0 | 367.0 | 35.0 |
| LM2940IMP-12 | SOT-223 | DCY | 4 | 1000 | 367.0 | 367.0 | 35.0 |
| LM2940IMP-12/NOPB | SOT-223 | DCY | 4 | 1000 | 367.0 | 367.0 | 35.0 |
| LM2940IMP-15 | SOT-223 | DCY | 4 | 1000 | 367.0 | 367.0 | 35.0 |
| LM2940IMP-15/NOPB | SOT-223 | DCY | 4 | 1000 | 367.0 | 367.0 | 35.0 |
| LM2940IMP-5.0 | SOT-223 | DCY | 4 | 1000 | 367.0 | 367.0 | 35.0 |
| LM2940IMP-5.0/NOPB | SOT-223 | DCY | 4 | 1000 | 367.0 | 367.0 | 35.0 |
| LM2940IMP-9.0/NOPB | SOT-223 | DCY | 4 | 1000 | 367.0 | 367.0 | 35.0 |
| LM2940IMPX-10/NOPB | SOT-223 | DCY | 4 | 2000 | 367.0 | 367.0 | 35.0 |
| LM2940IMPX-12/NOPB | SOT-223 | DCY | 4 | 2000 | 367.0 | 367.0 | 35.0 |
| LM2940IMPX-5.0/NOPB | SOT-223 | DCY | 4 | 2000 | 367.0 | 367.0 | 35.0 |
| LM2940IMPX-8.0/NOPB | SOT-223 | DCY | 4 | 2000 | 367.0 | 367.0 | 35.0 |
| LM2940LD-12 | WSON | NGN | 8 | 1000 | 210.0 | 185.0 | 35.0 |
| LM2940LD-12/NOPB | WSON | NGN | 8 | 1000 | 213.0 | 191.0 | 55.0 |

| Device | Package Type | Package Drawing | Pins | SPQ | Length (mm) | Width (mm) | Height (mm) |
|-------------------|--------------|-----------------|------|------|-------------|------------|-------------|
| LM2940LD-5.0/NOPB | WSON | NGN | 8 | 1000 | 213.0 | 191.0 | 55.0 |
| LM2940SX-10 | DDPAK/TO-263 | KTT | 3 | 500 | 367.0 | 367.0 | 45.0 |
| LM2940SX-10/NOPB | DDPAK/TO-263 | KTT | 3 | 500 | 367.0 | 367.0 | 45.0 |
| LM2940SX-12 | DDPAK/TO-263 | KTT | 3 | 500 | 367.0 | 367.0 | 45.0 |
| LM2940SX-12/NOPB | DDPAK/TO-263 | KTT | 3 | 500 | 367.0 | 367.0 | 45.0 |
| LM2940SX-5.0 | DDPAK/TO-263 | KTT | 3 | 500 | 367.0 | 367.0 | 45.0 |
| LM2940SX-5.0/NOPB | DDPAK/TO-263 | KTT | 3 | 500 | 367.0 | 367.0 | 45.0 |
| LM2940SX-8.0/NOPB | DDPAK/TO-263 | KTT | 3 | 500 | 367.0 | 367.0 | 45.0 |
| LM2940SX-9.0/NOPB | DDPAK/TO-263 | KTT | 3 | 500 | 367.0 | 367.0 | 45.0 |

NDE0003B



NDG0003F

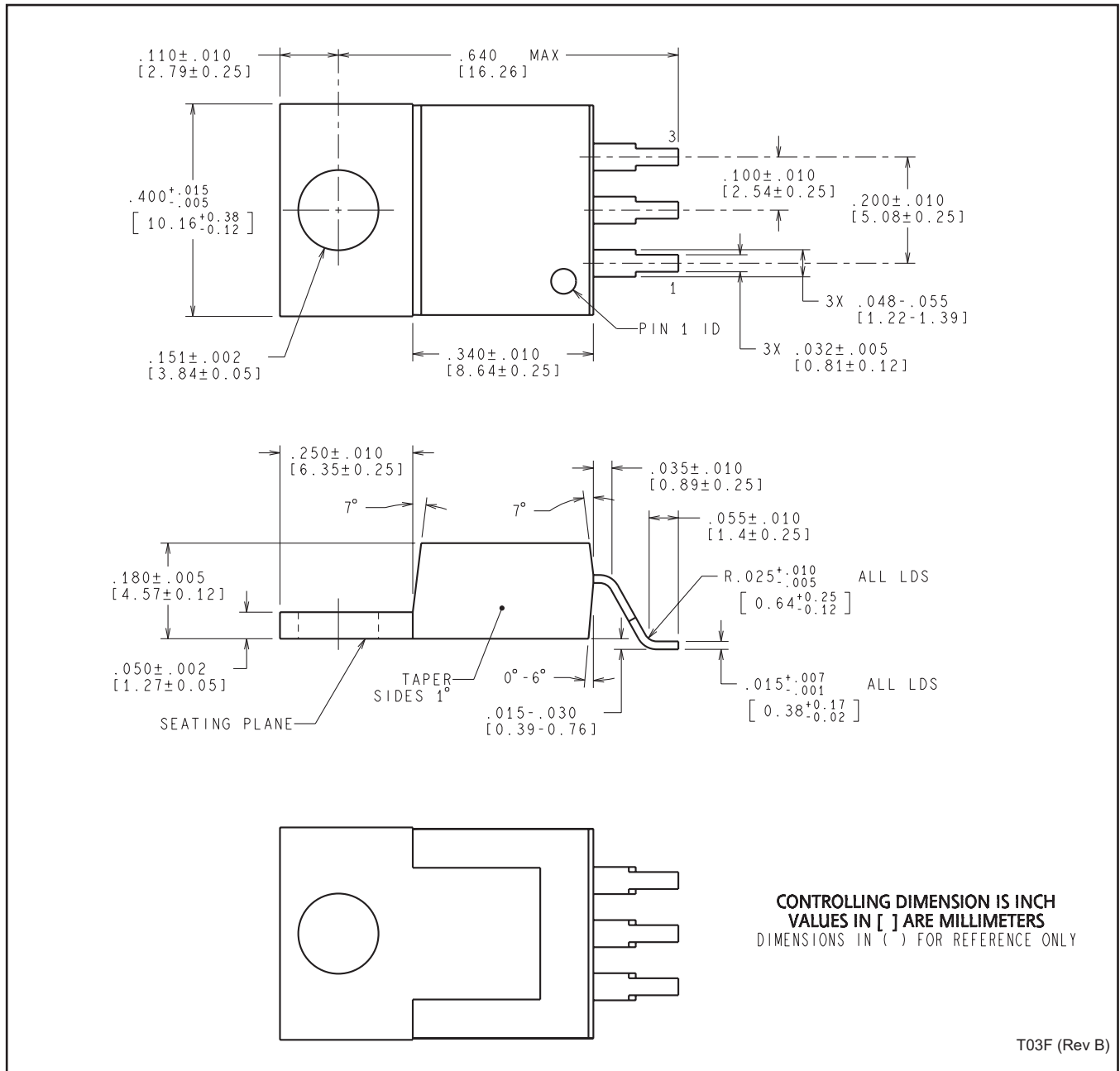

DCY (R-PDSO-G4)

PLASTIC SMALL-OUTLINE



- NOTES: A. All linear dimensions are in millimeters (inches).
 B. This drawing is subject to change without notice.
 C. Body dimensions do not include mold flash or protrusion.
 D. Falls within JEDEC TO-261 Variation AA.

DCY (R-PDSO-G4)

PLASTIC SMALL OUTLINE

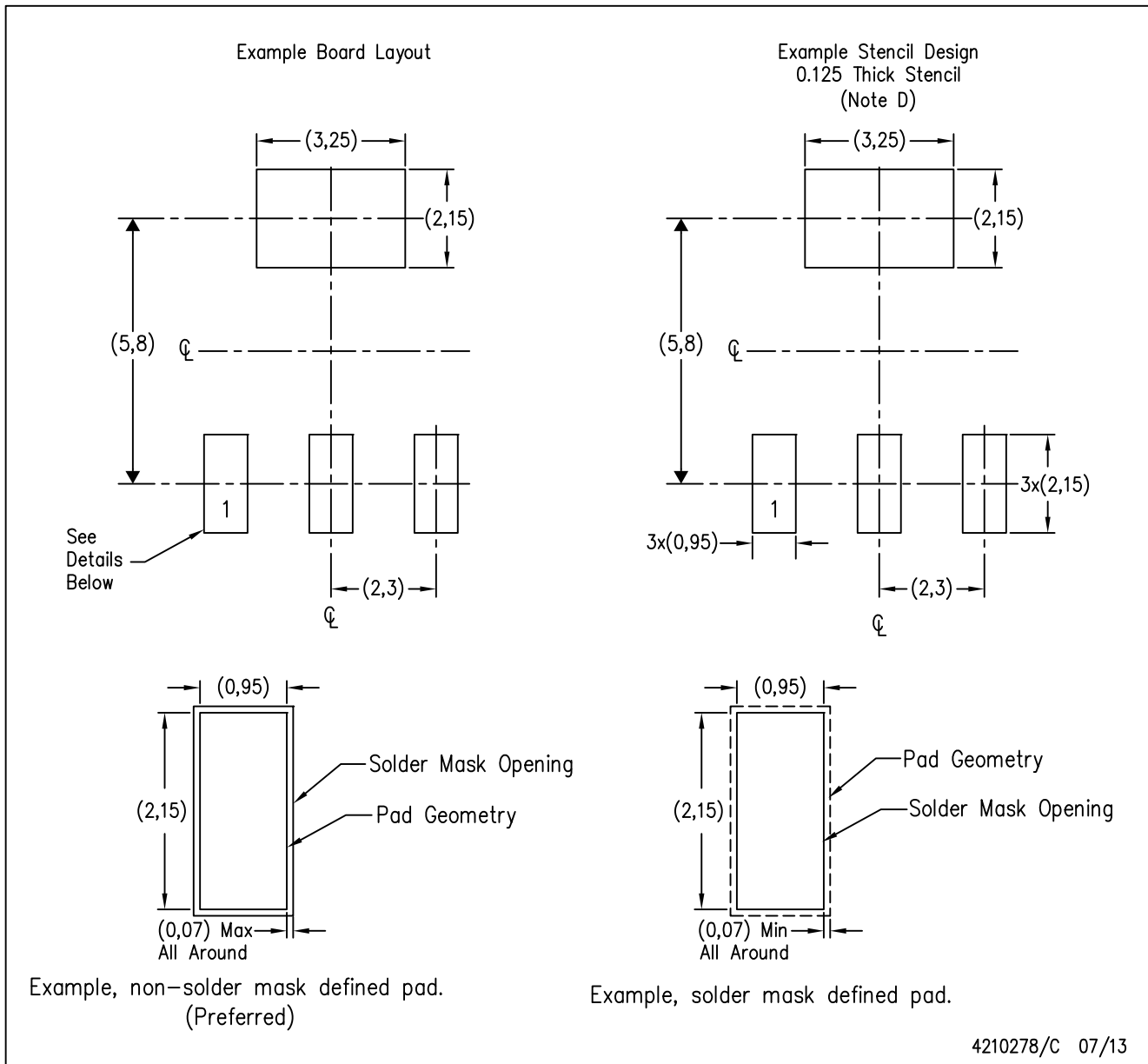

- NOTES:
- A. All linear dimensions are in millimeters.
 - B. This drawing is subject to change without notice.
 - C. Publication IPC-7351 is recommended for alternate designs.
 - D. Laser cutting apertures with trapezoidal walls and also rounding corners will offer better paste release. Customers should contact their board assembly site for stencil recommendations. Refer to IPC 7525 for stencil design considerations.

NGN0008A

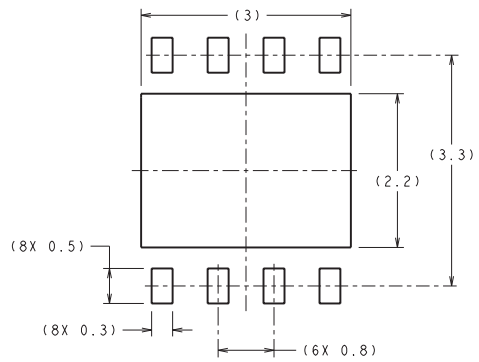

RECOMMENDED LAND PATTERN
1:1 RATION WITH PKG SOLDER PADS

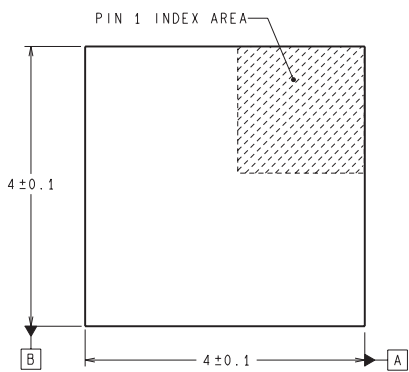

DIMENSIONS ARE IN MILLIMETERS
DIMENSIONS IN () FOR REFERENCE ONLY

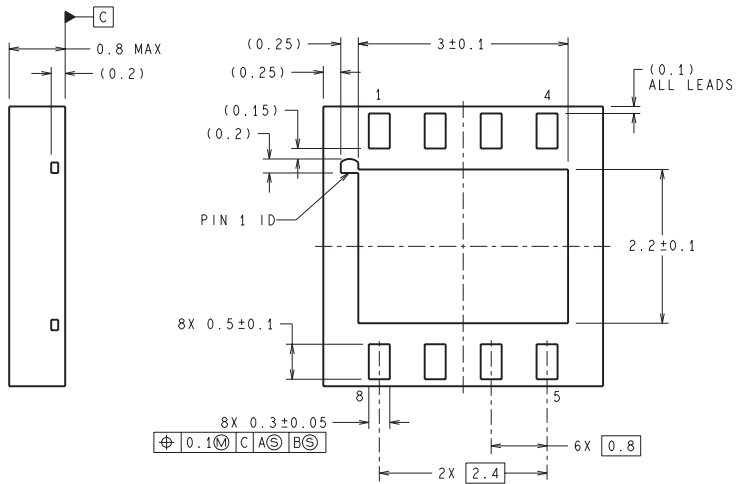

LDC08A (Rev B)

KTT0003B

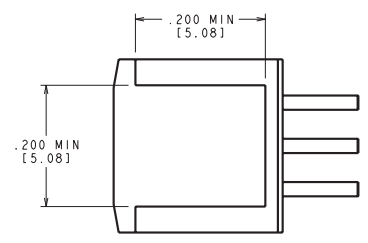
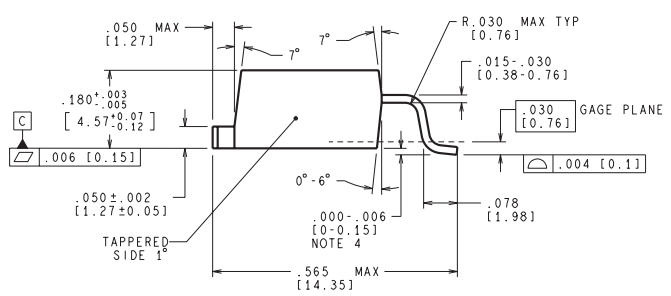
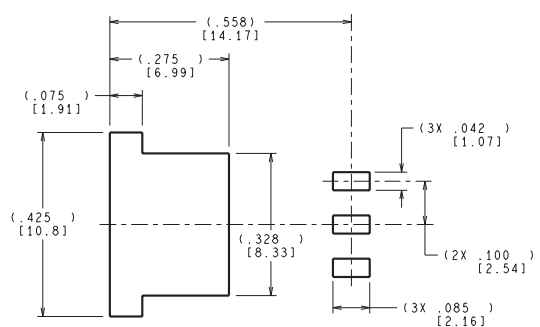
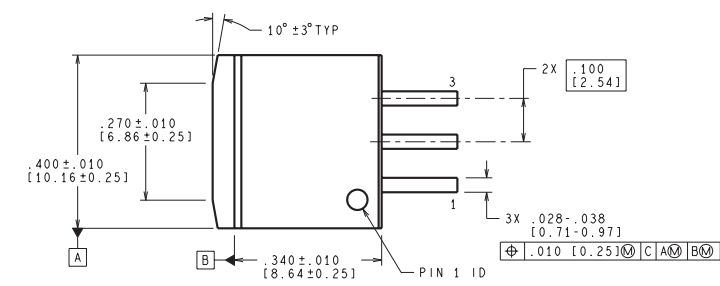

BOTTOM SIDE OF PACKAGE

CONTROLLING DIMENSION IS INCH
 VALUES IN [] ARE MILLIMETERS
 DIMENSIONS IN () FOR REFERENCE ONLY

TS3B (Rev F)

NEB0003G

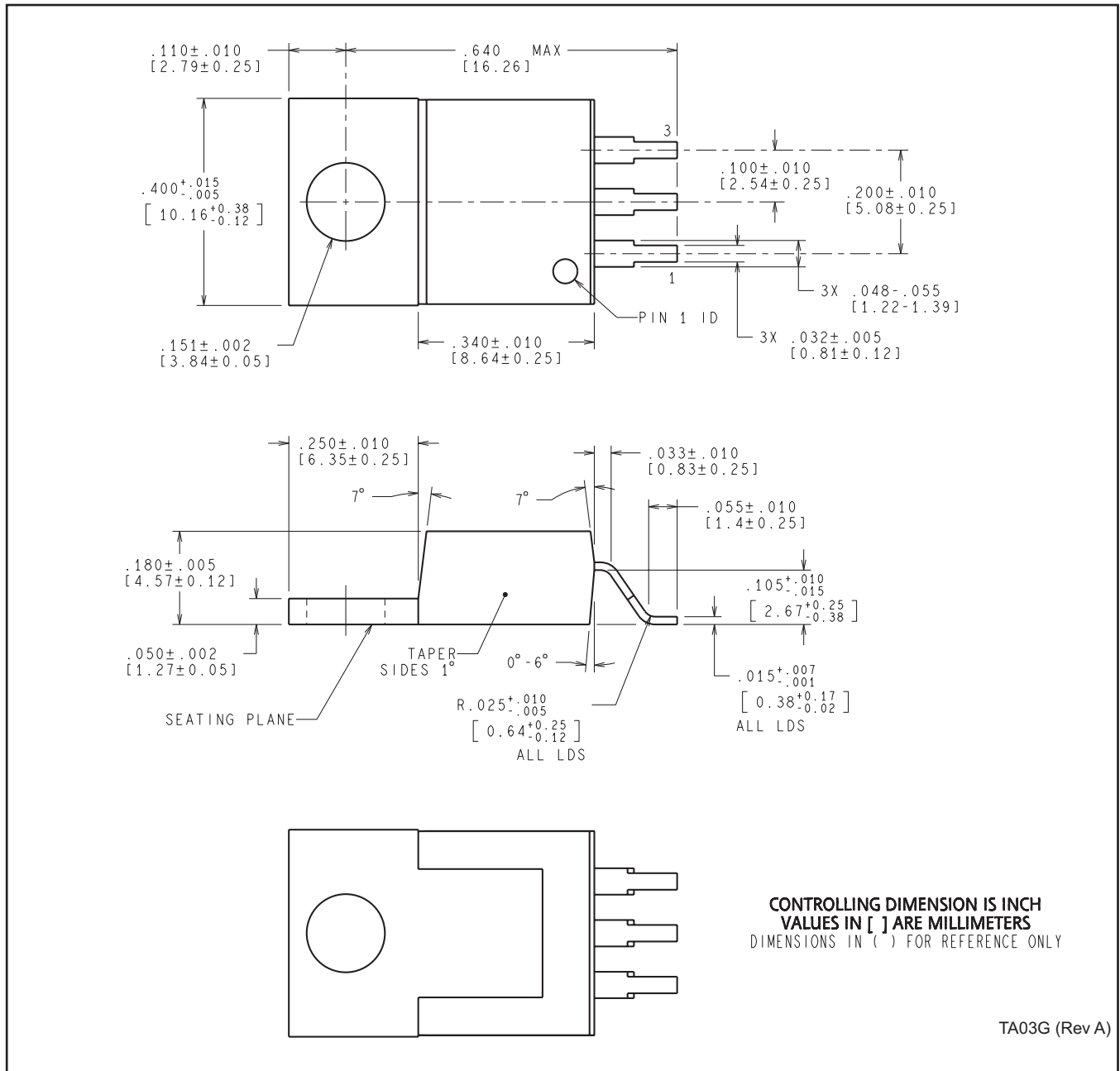

TA03G (Rev A)

IMPORTANT NOTICE

Texas Instruments Incorporated and its subsidiaries (TI) reserve the right to make corrections, enhancements, improvements and other changes to its semiconductor products and services per JESD46, latest issue, and to discontinue any product or service per JESD48, latest issue. Buyers should obtain the latest relevant information before placing orders and should verify that such information is current and complete. All semiconductor products (also referred to herein as "components") are sold subject to TI's terms and conditions of sale supplied at the time of order acknowledgment.

TI warrants performance of its components to the specifications applicable at the time of sale, in accordance with the warranty in TI's terms and conditions of sale of semiconductor products. Testing and other quality control techniques are used to the extent TI deems necessary to support this warranty. Except where mandated by applicable law, testing of all parameters of each component is not necessarily performed.

TI assumes no liability for applications assistance or the design of Buyers' products. Buyers are responsible for their products and applications using TI components. To minimize the risks associated with Buyers' products and applications, Buyers should provide adequate design and operating safeguards.

TI does not warrant or represent that any license, either express or implied, is granted under any patent right, copyright, mask work right, or other intellectual property right relating to any combination, machine, or process in which TI components or services are used. Information published by TI regarding third-party products or services does not constitute a license to use such products or services or a warranty or endorsement thereof. Use of such information may require a license from a third party under the patents or other intellectual property of the third party, or a license from TI under the patents or other intellectual property of TI.

Reproduction of significant portions of TI information in TI data books or data sheets is permissible only if reproduction is without alteration and is accompanied by all associated warranties, conditions, limitations, and notices. TI is not responsible or liable for such altered documentation. Information of third parties may be subject to additional restrictions.

Resale of TI components or services with statements different from or beyond the parameters stated by TI for that component or service voids all express and any implied warranties for the associated TI component or service and is an unfair and deceptive business practice. TI is not responsible or liable for any such statements.

Buyer acknowledges and agrees that it is solely responsible for compliance with all legal, regulatory and safety-related requirements concerning its products, and any use of TI components in its applications, notwithstanding any applications-related information or support that may be provided by TI. Buyer represents and agrees that it has all the necessary expertise to create and implement safeguards which anticipate dangerous consequences of failures, monitor failures and their consequences, lessen the likelihood of failures that might cause harm and take appropriate remedial actions. Buyer will fully indemnify TI and its representatives against any damages arising out of the use of any TI components in safety-critical applications.

In some cases, TI components may be promoted specifically to facilitate safety-related applications. With such components, TI's goal is to help enable customers to design and create their own end-product solutions that meet applicable functional safety standards and requirements. Nonetheless, such components are subject to these terms.

No TI components are authorized for use in FDA Class III (or similar life-critical medical equipment) unless authorized officers of the parties have executed a special agreement specifically governing such use.

Only those TI components which TI has specifically designated as military grade or "enhanced plastic" are designed and intended for use in military/aerospace applications or environments. Buyer acknowledges and agrees that any military or aerospace use of TI components which have **not** been so designated is solely at the Buyer's risk, and that Buyer is solely responsible for compliance with all legal and regulatory requirements in connection with such use.

TI has specifically designated certain components as meeting ISO/TS16949 requirements, mainly for automotive use. In any case of use of non-designated products, TI will not be responsible for any failure to meet ISO/TS16949.

Products

| | |
|------------------------------|--|
| Audio | www.ti.com/audio |
| Amplifiers | amplifier.ti.com |
| Data Converters | dataconverter.ti.com |
| DLP® Products | www.dlp.com |
| DSP | dsp.ti.com |
| Clocks and Timers | www.ti.com/clocks |
| Interface | interface.ti.com |
| Logic | logic.ti.com |
| Power Mgmt | power.ti.com |
| Microcontrollers | microcontroller.ti.com |
| RFID | www.ti-rfid.com |
| OMAP Applications Processors | www.ti.com/omap |
| Wireless Connectivity | www.ti.com/wirelessconnectivity |

Applications

| | |
|-------------------------------|--|
| Automotive and Transportation | www.ti.com/automotive |
| Communications and Telecom | www.ti.com/communications |
| Computers and Peripherals | www.ti.com/computers |
| Consumer Electronics | www.ti.com/consumer-apps |
| Energy and Lighting | www.ti.com/energy |
| Industrial | www.ti.com/industrial |
| Medical | www.ti.com/medical |
| Security | www.ti.com/security |
| Space, Avionics and Defense | www.ti.com/space-avionics-defense |
| Video and Imaging | www.ti.com/video |

TI E2E Community

e2e.ti.com