

DIP SWITCH D(M)(J)(L) SERIES

SMT Type

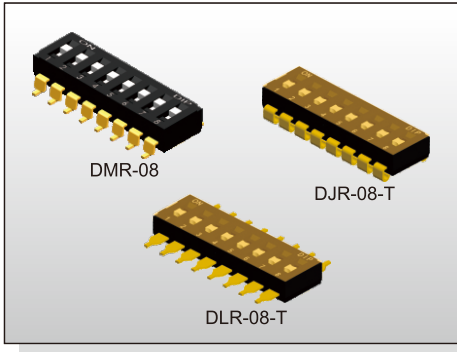

FEATURES

- ※Low profile for space saving
- ※Gold contact for high reliability
- ※Top tape type for washing process

APPLICATION

- ※Industrial control
- ※Automatic machines control
- ※Telecommunication

SPECIFICATION

| | |
|-----------------------|--------------------|
| Contact Rating | 25mA, 24V DC |
| Contact Resistance | 50mΩ max. |
| Insulation Resistance | 100MΩ min. 500V DC |
| Dielectric Strength | 500V AC/1 minute |
| Operating Force | 1,000gf max. |
| Travel | 1mm |
| Operating Life | 2,000 cycles |
| Operating Temp. | -20°C ~ +85°C |
| Storage Temp. | -40°C ~ +85°C |

CIRCUIT

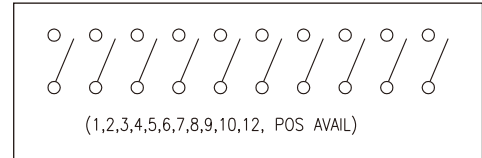

PACKAGE

<Tube>

DM(R), DJ(R):

- 01: 130 pcs 02: 76 pcs 03: 55 pcs 04: 42 pcs
- 05: 35 pcs 06: 28 pcs 07: 25 pcs 08: 22 pcs
- 09: 20 pcs 10: 18 pcs 12: 15 pcs

<Tape & Reel>

- DM(R)-01: 800 pcs
- DMR-02~DMR-12: 900 pcs
- DM-(01)(05)(07): 800 pcs
- DM-(02)(03)(04)(06)(08)(09)(10)(12): 700 pcs
- DJR-(02)(03)(04)(08)(09)(10): 1000 pcs

<Bag>

DL(R): 1000 pcs

HOW TO ORDER

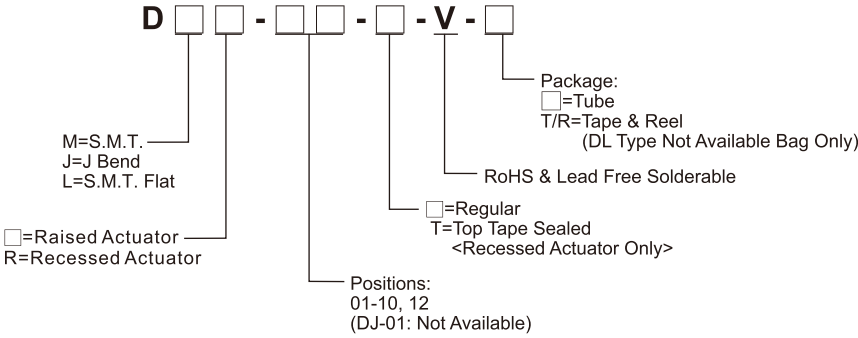

DM(R)

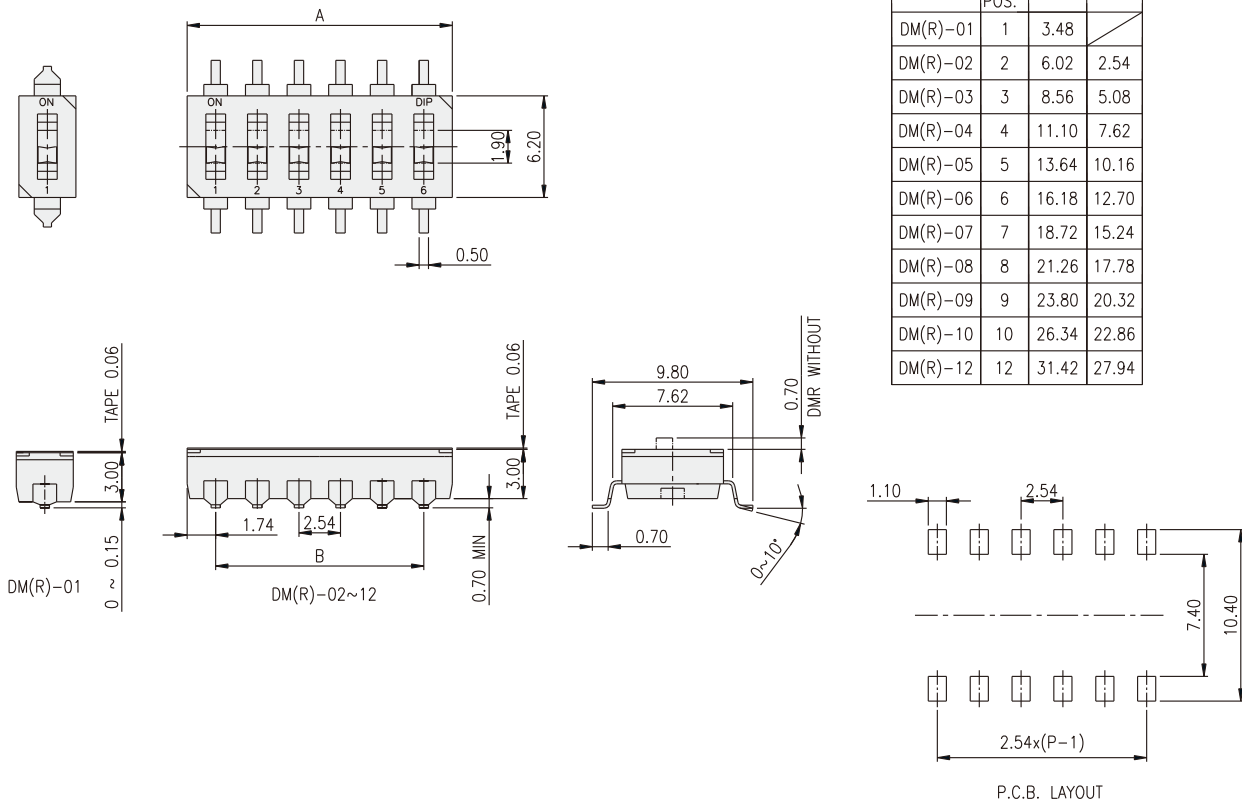

DJ(R)

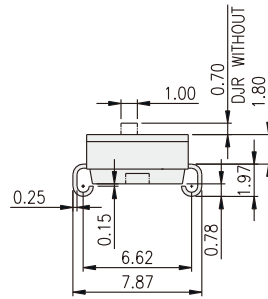
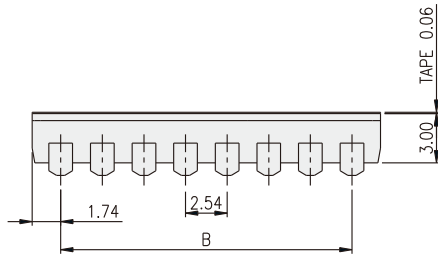
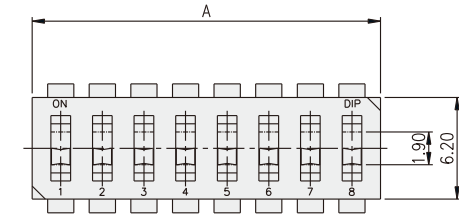

| PART NO. | NO.OF POS. | DIM.A | DIM.B |
|----------|------------|-------|-------|
| DJ(R)-02 | 2 | 6.02 | 2.54 |
| DJ(R)-03 | 3 | 8.56 | 5.08 |
| DJ(R)-04 | 4 | 11.10 | 7.62 |
| DJ(R)-05 | 5 | 13.64 | 10.16 |
| DJ(R)-06 | 6 | 16.18 | 12.70 |
| DJ(R)-07 | 7 | 18.72 | 15.24 |
| DJ(R)-08 | 8 | 21.26 | 17.78 |
| DJ(R)-09 | 9 | 23.80 | 20.32 |
| DJ(R)-10 | 10 | 26.34 | 22.86 |
| DJ(R)-12 | 12 | 31.42 | 27.94 |

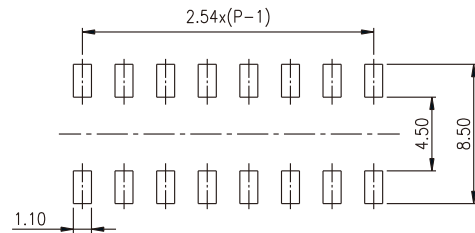

P.C.B. LAYOUT

DL(R)

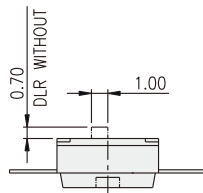
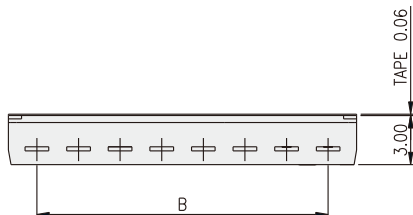
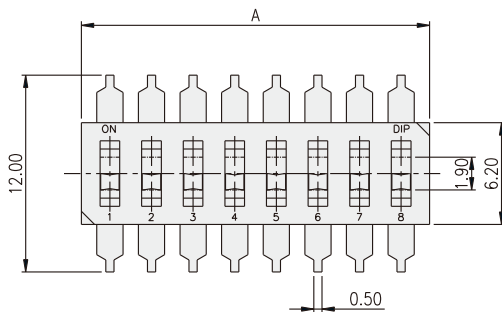

| PART NO. | NO.OF POS. | DIM.A | DIM.B |
|----------|------------|-------|-------|
| DL(R)-01 | 1 | 3.48 | |
| DL(R)-02 | 2 | 6.02 | 2.54 |
| DL(R)-03 | 3 | 8.56 | 5.08 |
| DL(R)-04 | 4 | 11.10 | 7.62 |
| DL(R)-05 | 5 | 13.64 | 10.16 |
| DL(R)-06 | 6 | 16.18 | 12.70 |
| DL(R)-07 | 7 | 18.72 | 15.24 |
| DL(R)-08 | 8 | 21.26 | 17.78 |
| DL(R)-09 | 9 | 23.80 | 20.32 |
| DL(R)-10 | 10 | 26.34 | 22.86 |
| DL(R)-12 | 12 | 31.42 | 27.94 |

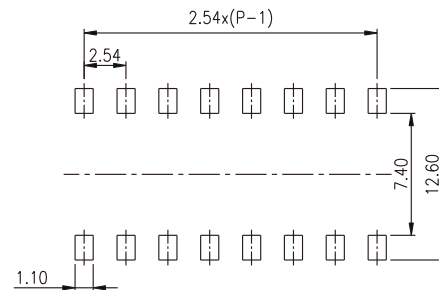

P.C.B. LAYOUT