

MBRA320T3G

Surface Mount Schottky Power Rectifier SMA Power Surface Mount Package

Employing the Schottky Barrier principle in a large area metal-to-silicon power diode. State of the art geometry features epitaxial construction with oxide passivation and metal overlay contact. Ideally suited for low voltage, high frequency rectification, or as free wheeling and polarity diodes in surface mount applications where compact size and weight are critical to the system.

Features

- Small Compact Surface Mountable Package with J-Bent Leads
- Rectangular Package for Automated Handling
- Highly Stable Oxide Passivated Junction
- Very Low Forward Voltage Drop
- Guardring for Stress Protection
- NRVBA Prefix for Automotive and Other Applications Requiring Unique Site and Control Change Requirements; AEC-Q101 Qualified and PPAP Capable
- These are Pb-Free Devices

Mechanical Characteristics:

- Case: Epoxy, Molded
- Weight: 70 mg (approximately)
- Finish: All External Surfaces Corrosion Resistant and Terminal Leads are Readily Solderable
- Lead and Mounting Surface Temperature for Soldering Purposes: 260°C Max. for 10 Seconds
- Shipped in 12 mm tape, 5000 units per 13 inch reel
- Polarity: Cathode Lead Indicated by Polarity Band
- ESD Ratings: Machine Model = C
Human Body Model = 3B
- Device Meets MSL 1 Requirements

MAXIMUM RATINGS

Rating	Symbol	Value	Unit
Peak Repetitive Reverse Voltage Working Peak Reverse Voltage DC Blocking Voltage	V_{RRM} V_{RWM} V_R	20	V
Average Rectified Forward Current (At Rated V_R , $T_L = 100^\circ\text{C}$)	I_O	3.0	A
Non-Repetitive Peak Surge Current (Surge Applied at Rated Load Conditions Halfwave, Single Phase, 60 Hz)	I_{FSM}	80	A
Storage Temperature	T_{stg}	-65 to +150	°C
Operating Junction Temperature	T_J	-65 to +125	°C
Voltage Rate of Change (Rated V_R , $T_J = 25^\circ\text{C}$)	dv/dt	10,000	V/ μs

Stresses exceeding those listed in the Maximum Ratings table may damage the device. If any of these limits are exceeded, device functionality should not be assumed, damage may occur and reliability may be affected.



ON Semiconductor®

<http://onsemi.com>

SCHOTTKY BARRIER RECTIFIER 3.0 AMPERES 20 VOLTS

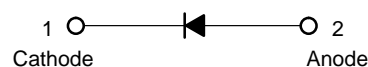

SMA
CASE 403D

MARKING DIAGRAM

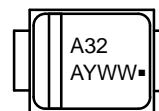

- A32 = Device Code
- A = Assembly Location
- Y = Year
- WW = Work Week
- = Pb-Free Package

ORDERING INFORMATION

Device	Package	Shipping†
MBRA320T3G	SMA (Pb-Free)	5000/Tape & Reel
NRVBA320T3G	SMA (Pb-Free)	5000/Tape & Reel

†For information on tape and reel specifications, including part orientation and tape sizes, please refer to our Tape and Reel Packaging Specification Brochure, BRD8011/D.

MBRA320T3G

THERMAL CHARACTERISTICS

Characteristic	Symbol	Value	Unit
Thermal Resistance – Junction–to–Lead (Note 1)	$R_{\theta JL}$	15	$^{\circ}\text{C}/\text{W}$
Thermal Resistance – Junction–to–Ambient (Note 1)	$R_{\theta JA}$	80	$^{\circ}\text{C}/\text{W}$

ELECTRICAL CHARACTERISTICS

Maximum Instantaneous Forward Voltage (Note 2)	($I_F = 3.0 \text{ A}$, $T_J = 25^{\circ}\text{C}$)	V_F	0.50	Volts
Maximum Instantaneous Reverse Current (Note 2)	(V _R = 20 V)	I_R	$T_J = 25^{\circ}\text{C}$	mA
			$T_J = 100^{\circ}\text{C}$	
			2.0	20

Product parametric performance is indicated in the Electrical Characteristics for the listed test conditions, unless otherwise noted. Product performance may not be indicated by the Electrical Characteristics if operated under different conditions.

1. Mounted on 2" Square PC Board with 1" Square Total Pad Size, PC Board FR4.
2. Pulse Test: Pulse Width = 300 s, Duty Cycle $\leq 2.0\%$.

TYPICAL CHARACTERISTICS

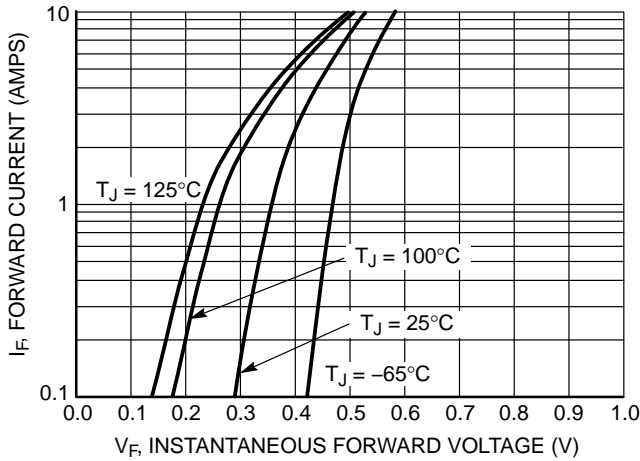

Figure 1. Typical Forward Voltage

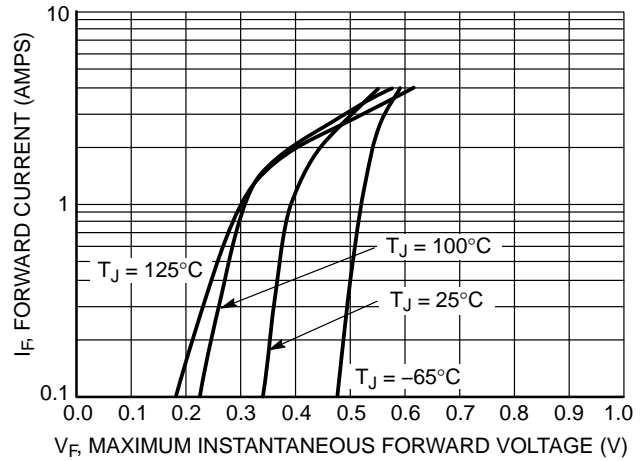

Figure 2. Maximum Forward Voltage

MBRA320T3G

TYPICAL CHARACTERISTICS

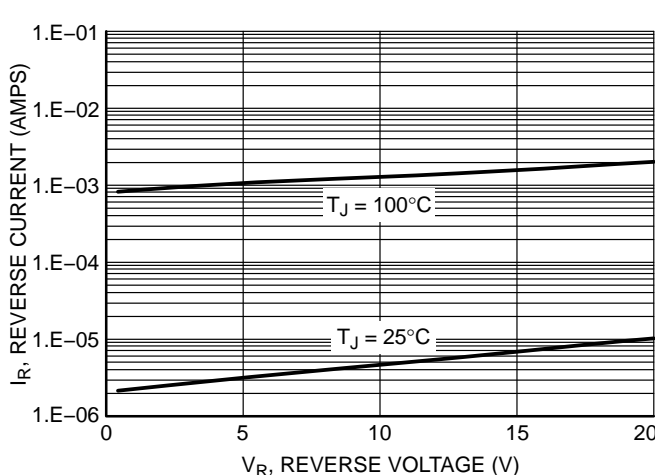

Figure 3. Typical Reverse Current

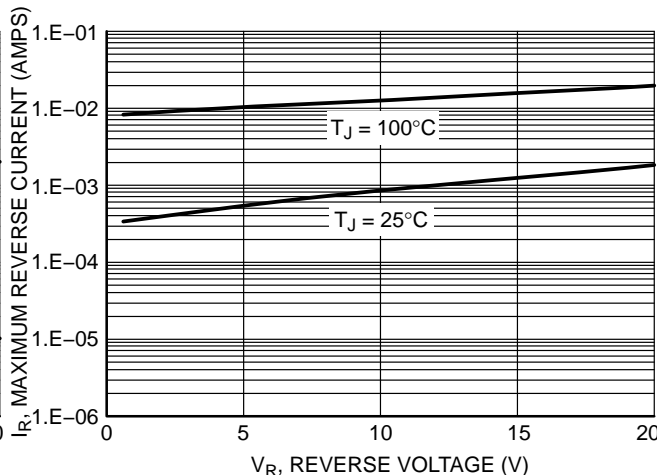

Figure 4. Maximum Reverse Current

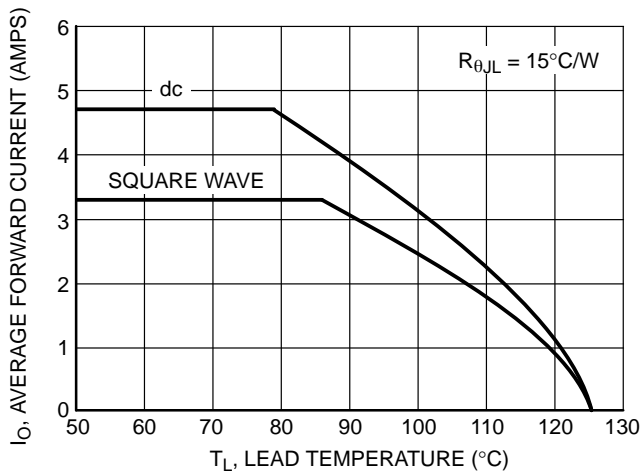

Figure 5. Current Derating

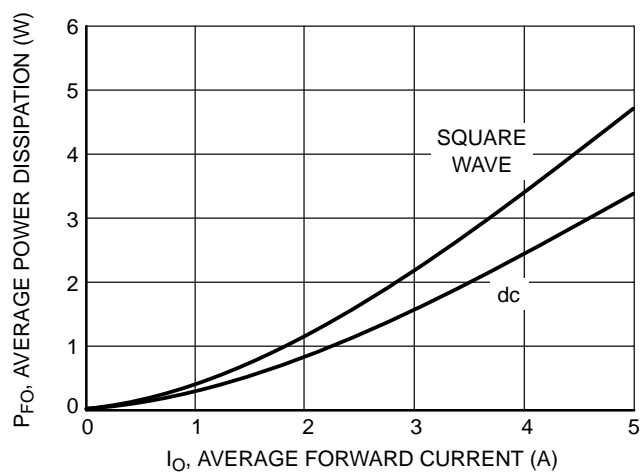

Figure 6. Forward Power Dissipation

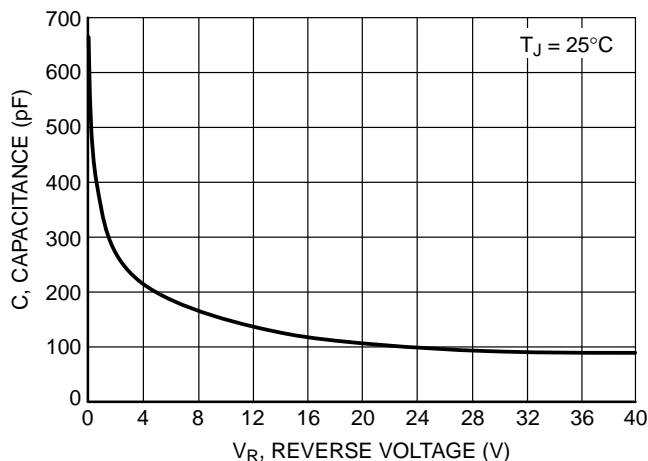

Figure 7. Typical Capacitance

MBRA320T3G

TYPICAL CHARACTERISTICS

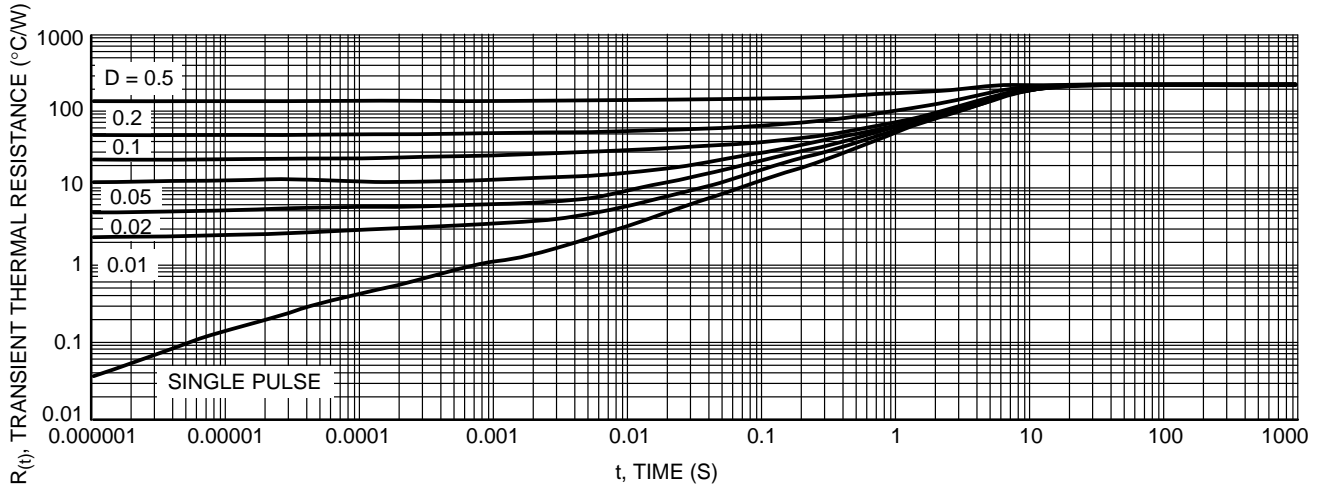

Figure 8. Thermal Response, Junction-to-Ambient (min pad)

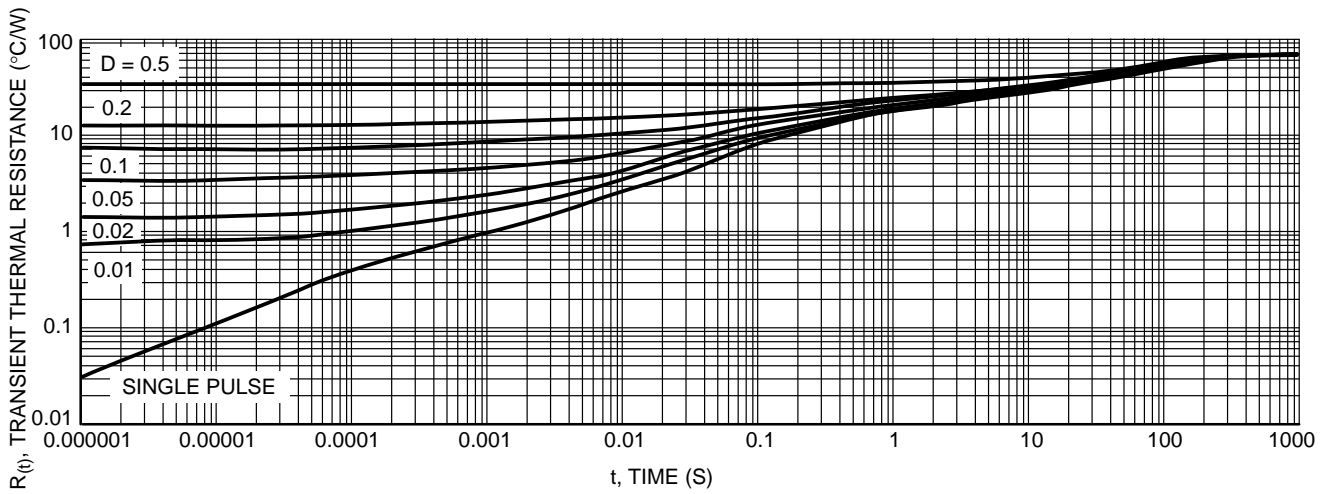
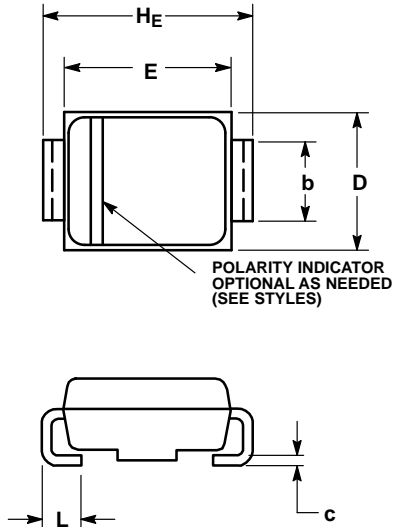

Figure 9. Thermal Response, Junction to Ambient (1 inch pad)

MBRA320T3G

PACKAGE DIMENSIONS

SMA
CASE 403D-02
ISSUE G



- NOTES:
1. DIMENSIONING AND TOLERANCING PER ANSI Y14.5M, 1982.
 2. CONTROLLING DIMENSION: INCH.
 3. DIMENSION b SHALL BE MEASURED WITHIN DIMENSION L.

DIM	MILLIMETERS			INCHES		
	MIN	NOM	MAX	MIN	NOM	MAX
A	1.97	2.10	2.20	0.078	0.083	0.087
A1	0.05	0.10	0.20	0.002	0.004	0.008
b	1.27	1.45	1.63	0.050	0.057	0.064
c	0.15	0.28	0.41	0.006	0.011	0.016
D	2.29	2.60	2.92	0.090	0.103	0.115
E	4.06	4.32	4.57	0.160	0.170	0.180
HE	4.83	5.21	5.59	0.190	0.205	0.220
L	0.76	1.14	1.52	0.030	0.045	0.060

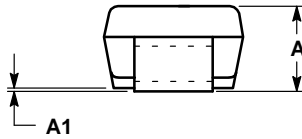

SOLDERING FOOTPRINT*

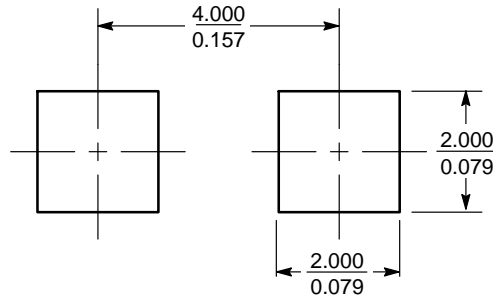

SCALE 8:1 ($\frac{\text{mm}}{\text{inches}}$)

*For additional information on our Pb-Free strategy and soldering details, please download the ON Semiconductor Soldering and Mounting Techniques Reference Manual, SOLDERRM/D.

ON Semiconductor and  are registered trademarks of Semiconductor Components Industries, LLC (SCILLC). SCILLC owns the rights to a number of patents, trademarks, copyrights, trade secrets, and other intellectual property. A listing of SCILLC's product/patent coverage may be accessed at www.onsemi.com/site/pdf/Patent-Marking.pdf. SCILLC reserves the right to make changes without further notice to any products herein. SCILLC makes no warranty, representation or guarantee regarding the suitability of its products for any particular purpose, nor does SCILLC assume any liability arising out of the application or use of any product or circuit, and specifically disclaims any and all liability, including without limitation special, consequential or incidental damages. "Typical" parameters which may be provided in SCILLC data sheets and/or specifications can and do vary in different applications and actual performance may vary over time. All operating parameters, including "Typicals" must be validated for each customer application by customer's technical experts. SCILLC does not convey any license under its patent rights nor the rights of others. SCILLC products are not designed, intended, or authorized for use as components in systems intended for surgical implant into the body, or other applications intended to support or sustain life, or for any other application in which the failure of the SCILLC product could create a situation where personal injury or death may occur. Should Buyer purchase or use SCILLC products for any such unintended or unauthorized application, Buyer shall indemnify and hold SCILLC and its officers, employees, subsidiaries, affiliates, and distributors harmless against all claims, costs, damages, and expenses, and reasonable attorney fees arising out of, directly or indirectly, any claim of personal injury or death associated with such unintended or unauthorized use, even if such claim alleges that SCILLC was negligent regarding the design or manufacture of the part. SCILLC is an Equal Opportunity/Affirmative Action Employer. This literature is subject to all applicable copyright laws and is not for resale in any manner.

PUBLICATION ORDERING INFORMATION

LITERATURE FULFILLMENT:
Literature Distribution Center for ON Semiconductor
P.O. Box 5163, Denver, Colorado 80217 USA
Phone: 303-675-2175 or 800-344-3860 Toll Free USA/Canada
Fax: 303-675-2176 or 800-344-3867 Toll Free USA/Canada
Email: orderlit@onsemi.com

N. American Technical Support: 800-282-9855 Toll Free
USA/Canada
Europe, Middle East and Africa Technical Support:
Phone: 421 33 790 2910
Japan Customer Focus Center
Phone: 81-3-5817-1050

ON Semiconductor Website: www.onsemi.com
Order Literature: <http://www.onsemi.com/orderlit>
For additional information, please contact your local Sales Representative