



Thin Film Chip Fuse

Document No	TCFS-XX0S004I
Issued date	2012/11/26
Page	1/20

1. Scope

This specification applies for the fuse series of thin film chip fuse made by TA-I.

2. Construction

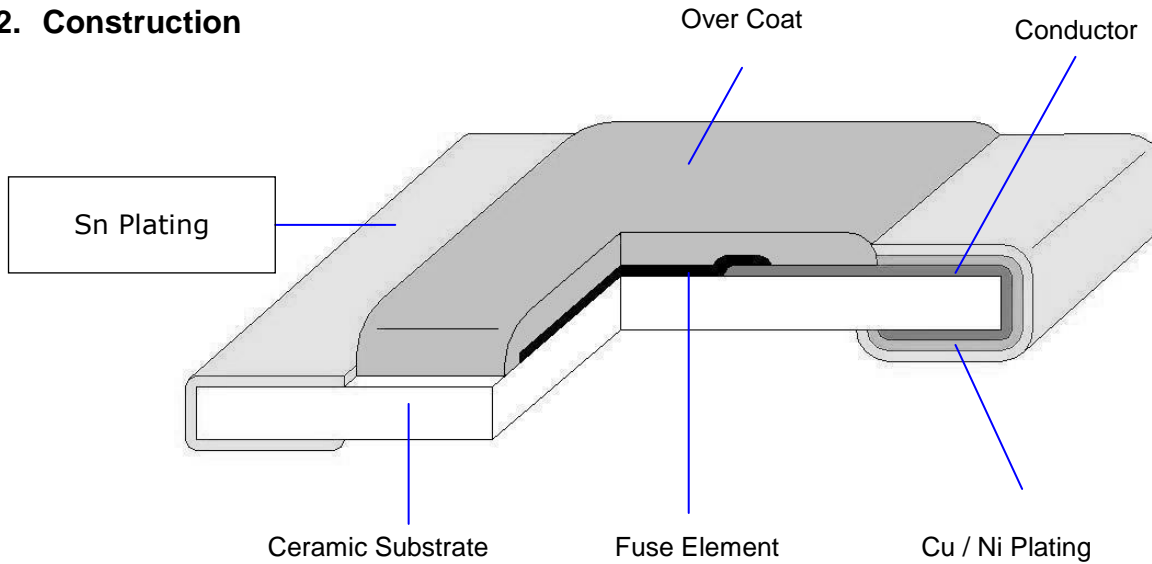

3. Type Designation





Thin Film Chip Fuse

Document No	TCFS-XX0S004I
Issued date	2012/11/26
Page	2/20

4. Dimensions

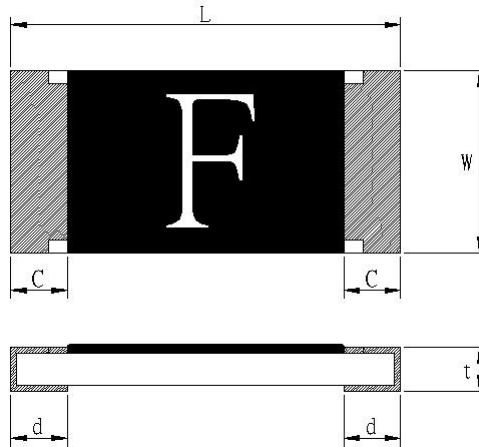

Unit: mm

Type (Inch Size code)	Dimensions (mm)				
	L	W	C	d	t
CFS04 (0402)	1.0±0.1	0.52±0.05	0.2±0.1	0.25±0.1	0.35±0.05
CFS06 (0603)	1.6±0.1	0.8±0.10	0.3±0.2	0.35±0.2	0.45±0.10
CFS12 (1206)	3.1±0.1	1.55±0.10	0.5±0.3	0.50±0.2	0.60±0.10

5. Applications and ratings

Part Designation	Marking	Rated Current	Fusing Time	Resistance (mΩ) Tolerance±25%	Rated Voltage	Breaking Capacity	Body Temperature rising
CFS04V3TR50	F	0.50A	Open within 5sec.at250% rated current	300	DC 32V	DC32V 35A	<75°C at 100% rated current
CFS04V3TR80	K	0.80A		78			
CFS04V3T1R0	L	1.00A		75			
CFS04V3T1R25	M	1.25A		44			
CFS04V3T1R50	P	1.50A		34.5			
CFS04V3T1R60	N	1.60A		29.5			
CFS04V3T2R0	S	2.00A		23			
CFS04V3T2R50	T	2.50A		18			
CFS04V3T3R0	3	3.00A		15			
CFS04V3T3R15	U	3.15A		14			
CFS04V3T4R0	W	4.00A		10			

*Resistance value was measured with less than 10% of rated current



Thin Film Chip Fuse

Document No	TCFS-XX0S004I
Issued date	2012/11/26
Page	3/20

Part Designation	Marking	Rated Current	Fusing Time	Resistance (mΩ) Tolerance±25%	Rated Voltage	Breaking Capacity	Body Temperature rising
CFS06V5TR40	<u>E</u>	0.4A	Open within 5sec.at250% rated current	350	DC 50V	50A DC50V/ AC35V	<75°C at 100% rated current
CFS06V5TR50	F	0.50A		232			
CFS06V3TR63	I	0.63A		150	DC 32V	50A DC32V/ AC35V	
CFS06V3TR70	J	0.70A		148			
CFS06V3TR80	K	0.80A		113			
CFS06V3T1R0	L	1.00A		67			
CFS06V3T1R25	<u>M</u>	1.25A		50			
CFS06V3T1R50	P	1.50A		42			
CFS06V3T1R60	N	1.60A		40			
CFS06V3T2R0	S	2.00A		27			
CFS06V3T2R50	T	2.50A		19.5			
CFS06V3T3R00	3	3.00A		16			
CFS06V3T3R15	U	3.15A		15			
CFS06V3T4R0	W	4.00A		11			
CFS06V3T5R0	Y	5.00A		8			
CFS06V3T6R0	<u>6</u>	6.00A		6			

*Resistance value was measured with less than 10% of rated current

Part Designation	Marking	Rated Current	Fusing Time	Resistance (mΩ) Tolerance±25%	Rated Voltage	Breaking Capacity	Body Temperature rising
CFS12V6TR50	F	0.50A	Open within 5sec.at250% rated current	596	DC 63V	DC63V 50A	<75°C at 100% rated current
CFS12V6TR80	K	0.80A		165			
CFS12V6T1R0	L	1.00A		132			
CFS12V6T1R25	<u>M</u>	1.25A		90			
CFS12V6T1R50	P	1.50A		79			
CFS12V6T2R0	S	2.00A		41			
CFS12V3T2R50	T	2.50A		33	DC 32V	DC32V 50A	
CFS12V3T3R00	3	3.00A		23			
CFS12V3T4R0	W	4.00A		15.5			
CFS12V3T5R0	Y	5.00A		13			
CFS12V3T7R0	Z	7.00A		7			

*Resistance value was measured with less than 10% of rated current



Thin Film Chip Fuse

Document No	TCFS-XX0S004I
Issued date	2012/11/26
Page	4/20

6. Temperature Derating Curve

6.1 Normal Ambient Temperature: 25°C

6.2 Operating Temperature: -20°C~105°C,whit proper Derating factor as below:

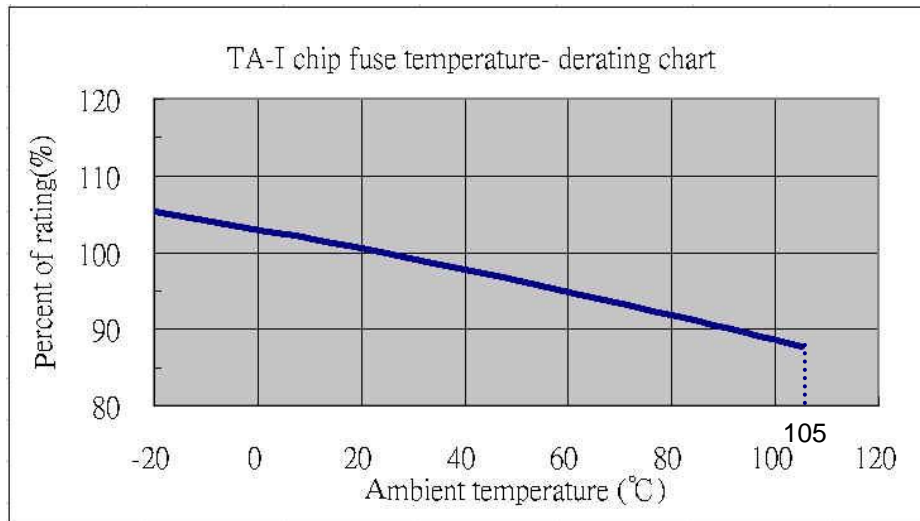

7. Reliability Tests

Parameter	Requirement	Test Method
Carrying capacity	No fusing	Rated current ,4hr
Fusing Time	Within 5sec	250% of its rated current
Interrupting Ability	No mechanical damages	After the fuse is interrupted ,rated voltage applied for 30sec again
Bending Test	No mechanical damages	Distance between holding points: 90mm, Bending:3mm,1time ,30sec
Resistance to solder Heat	±20%	260°C±5°C,10±1second
Solder ability	95% coverage minimum	235°C±5°C, 2±0.5second 245°C±5°C, 2±0.5second (Lead Free)
Temperature Rise	<75°C	100% of its rated current, Measure of surface temperature
Resistance to Dry Heat	±20%	105°C±5°C,1000 hrs
Resistance to Solvent	No evident damages on protective coating and marking	23°C±5°C of Isopropyl alcohol 90second
Residual Resistance	10kΩ and more	Measure DC resistance after fusing
Thermal Shock	ΔR< 10 %	-20°C/+25°C/+125°C/+25°C, 10 cycles



Thin Film Chip Fuse

Document No	TCFS-XX0S004I
Issued date	2012/11/26
Page	5/20

8. Marking

Symbol for Rating Current

Symbol	E	F	I	J	K	L	M	P	N	S	T	3	U	W	Y	Z
Rating Current(A)	0.4	0.5	0.63	0.7	0.8	1	1.25	1.5	1.6	2	2.5	3	3.15	4	5	7

9. Taping & Reel

9.1 Taping Dimensions

4mm pitch paper

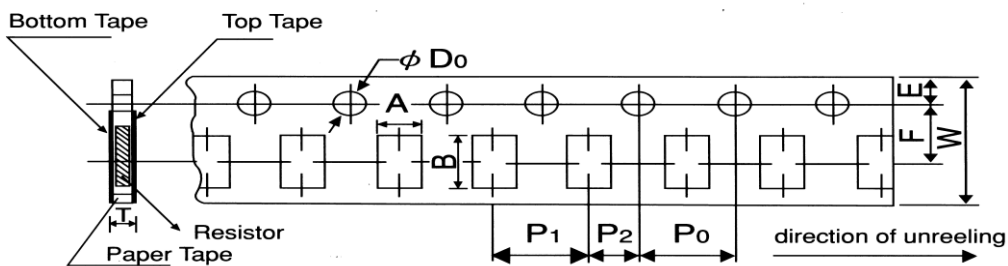

Packing	Type	A	B	W	F	E	P ₁	P ₂	P ₀	D ₀	T
Paper Tape	CFS04	0.7±0.05	1.2±0.05	8.0±0.2	3.5±0.05	1.75±0.1	2.0±0.1	2.0±0.05	4.0±0.1	$\phi 1.5^{+0.1}_0$	0.45±0.1
Paper Tape	CFS06	1.1±0.1	1.9±0.1	8.0±0.2	3.5±0.05	1.75±0.1	4.0±0.1	2.0±0.05	4.0±0.1	$\phi 1.5^{+0.1}_0$	0.64±0.1
Paper Tape	CFS12	2.0±0.15	3.6±0.2	8.0±0.2	3.5±0.05	1.75±0.1	4.0±0.1	2.0±0.05	4.0±0.1	$\phi 1.5^{+0.1}_0$	0.84±0.1

Unit: mm

Type	Size	Paper Tape
		2 mm pitch
		180mm/R
CFS	04	10000

Type series		Paper Tape
		4 mm pitch
		180mm/R
CFS	06	5000
CFS	12	5000



Thin Film Chip Fuse

Document No	TCFS-XX0S004I
Issued date	2012/11/26
Page	6/20

9.2 Reel Specifications

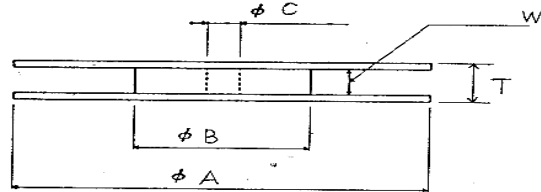
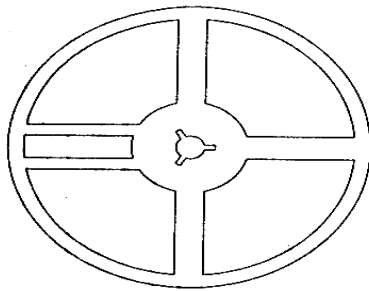

Unit: mm

Series	ϕA	ϕB	ϕC	W	T
CFS04	178 ±2.0	60.0±1.0	13.0±1.0	9.0±1.0	11.4±2.0
CFS06					
CFS12					

9.3 Peel –off force :

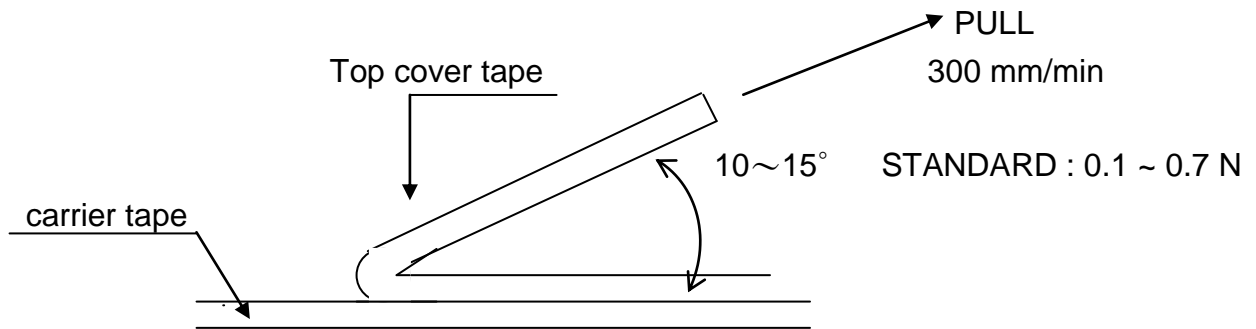

10. Storage Conditions:

Temperature: 5°C ~35°C, Humidity:40%~75%

11. Shelf Life:

2 years from manufacturing date



Thin Film Chip Fuse

Document No	TCFS-XX0S004I
Issued date	2012/11/26
Page	7/20

12. Label

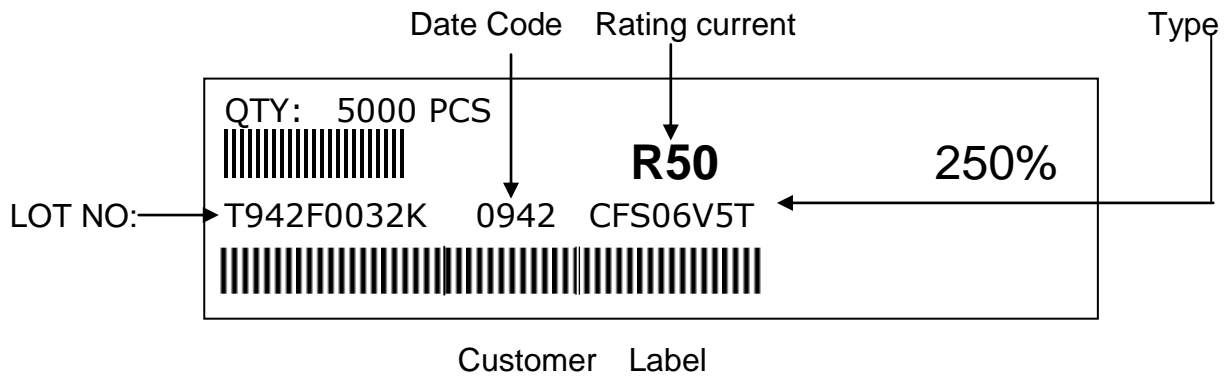

13. Recommended land patterns



Type	Land pattern Size	Dimension		
		a	b	c
CFS	04 (0402)	0.5~0.6	1.4~1.6	0.4~0.6
CFS	06 (0603)	0.7~0.9	2.0~2.2	0.8~1.0
CFS	12 (1206)	2.0~2.4	4.4~5.0	1.5~1.8



Thin Film Chip Fuse

Document No	TCFS-XX0S004I
Issued date	2012/11/26
Page	8/20

14. Recommend IR – Reflow profile : (solder : Sn96.5 / Ag3 / Cu0.5)

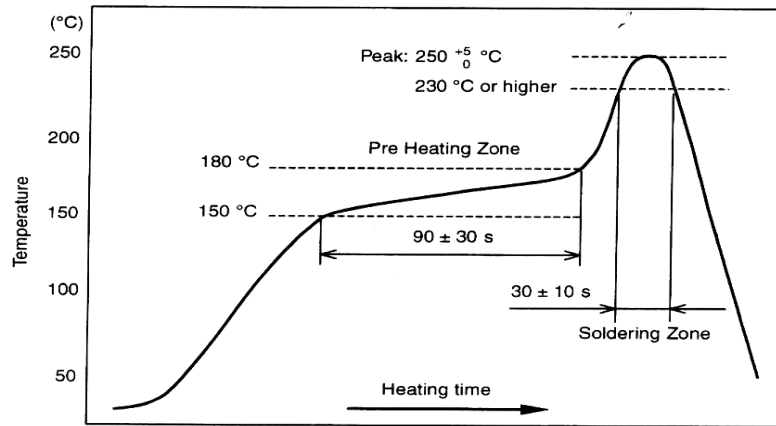

Peak : $250 \begin{matrix} +5 \\ -0 \end{matrix} ^\circ\text{C}$, 5 sec

Pre – heat Zone : 150 to 180 °C , 90±30 sec
Soldering Zone : 230°C or higher , 30±10 sec

15. Approval by UL248-14

The fuses have been approved by UL.
File No. of UL Recognition is E241710

16. ECN

Engineering Change Notice: The customer will be informed with ECN if there is significant modification on the characteristics and materials described in Approval Sheet.

17. Manufacturing Country & City :

TA-I TECHNOLOGY CO., LTD. (Taiwan– Tao Yuan)

Tel: (+886) 3-3246169 Fax : (+886) 3-3246167

Associated companies :

(1)TA-I TECHNOLOGY (SU ZHOU) CO., LTD. (China – Su Zhou)

Tel : (+86) 512-63457879 Fax : (+86) 512-63457869

(2) TA-I TECHNOLOGY ELECTRONIC (DONGGUAN) CO., LTD. (China –Dongguan)

Tel : (+86) 769-8339-4790~3 Fax : (+86) 769-8339-4794

(3) FORTUNE TASK RESISTOR FACTORY (China – Dongguan)

Tel : (+86) 769-8339-4790~3 Fax : (+86) 769-8339-4794

(4) TAI OHM ELECTRONICS (M) SDN. BHD. (Malaysia – Penang)

Tel : (+60) 4- 3900480 Fax : (+60) 4-3901481

(5) P.T.TAI ELECTRONIC Indonesia (Indonesia – Jakarta)

Tel : (+62) 21-44820254 Fax : (+62) 21-44820256



Document No	TCFS-XX0S004I
Issued date	2012/11/26
Page	9/20

★ Selection Guideline of Fuse:

■ Checklist of selection factors

- ⊙ Normal operating current
- ⊙ Normal operating voltage (AC or DC)
- ⊙ Ambient Temperature
- ⊙ Overload current and length of time in which the fuse must open .
- ⊙ Type of fuse (SMD or Tube) and physical size limitation (0603 or 1206)
- ⊙ Agency Approval required (e.g., UL248-14)

■ Normal operating current

e.g., Rectangular Wave, If $I_p = 1.5 A$, Normal operating current = 1.5 A

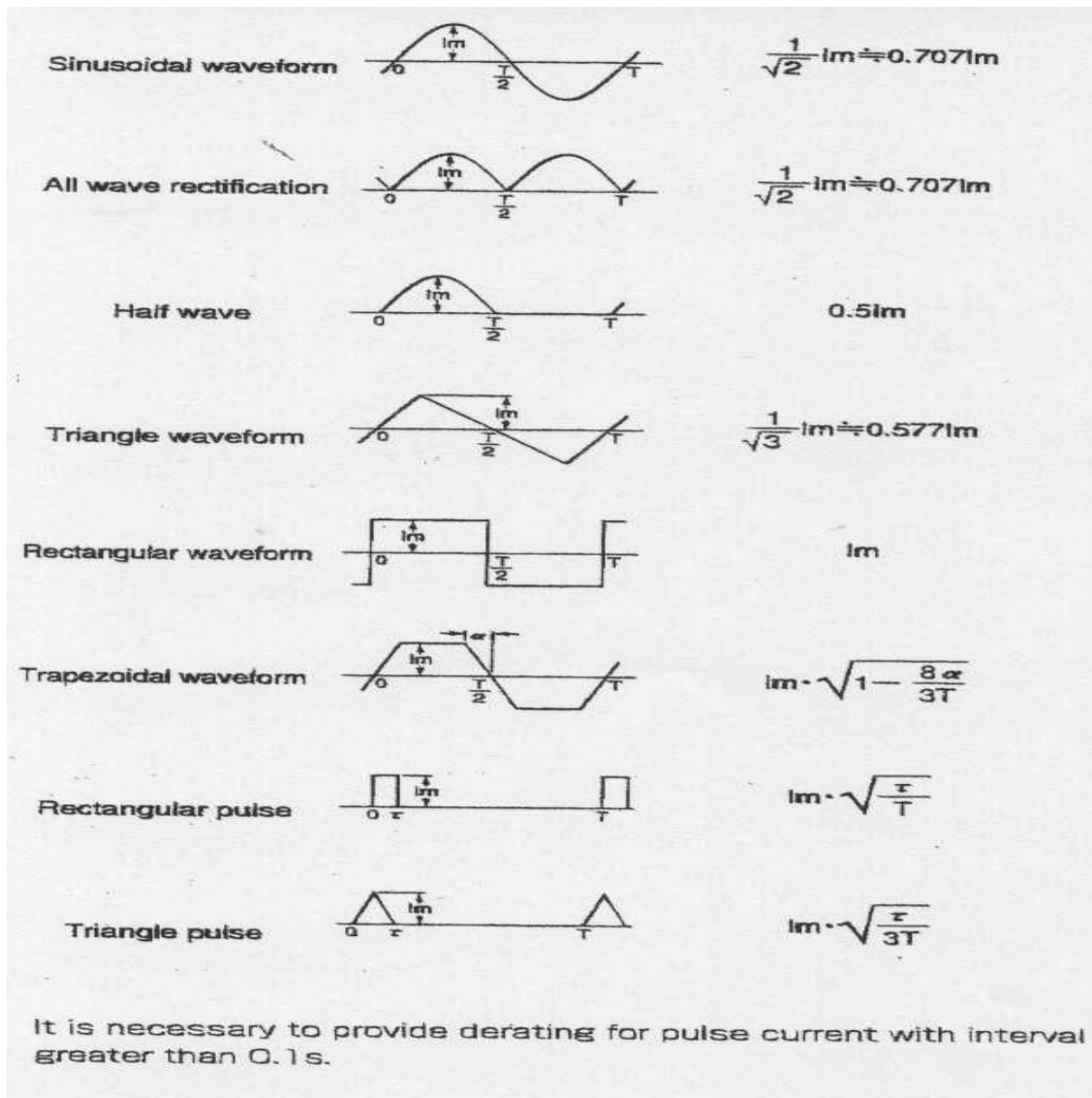



Thin Film Chip Fuse

Document No	TCFS-XX0S004I
Issued date	2012/11/26
Page	10/20

Derating ratio for different ambient Temperature

- Referring to bottom figure and select the appropriate derating ratio :
 e.g., Ambient temperature is 60 degree C
 the derating ratio \approx 0.95

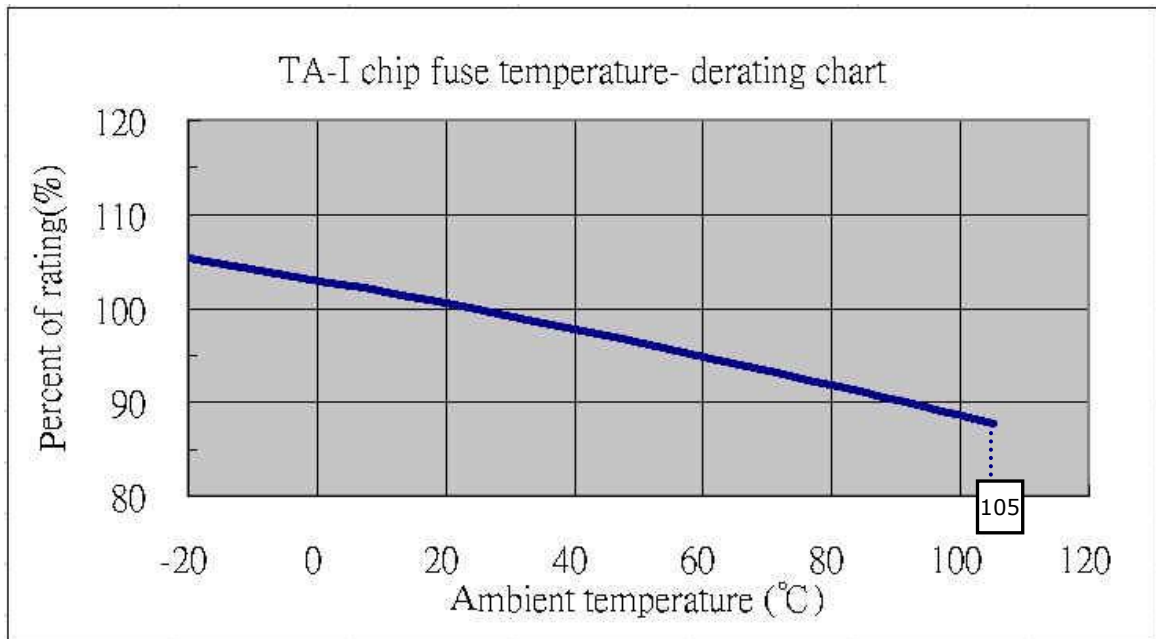

Calculating the required rating of fuse needed .

- Safety coefficient : 70 % is safety coefficient from practical experience

$$\frac{\text{Normal Operating Current}}{0.7 \times \text{derating ratio}} < \text{rating current of fuse}$$

\swarrow Safety coefficient
 \searrow Ambient temperature

e.g.,

Condition : Normal operating current =1.5 A
 Ambient temperature 40 °C : Derating ratio \approx 0.95

$$\frac{1.5}{0.7 \times 0.95} < \text{rating current of fuse}$$

2.255 < rating current of fuse



Thin Film Chip Fuse

Document No	TCFS-XX0S004I
Issued date	2012/11/26
Page	11/20

■ Determination of the type of fuse

e.g., Condition :

- ◆ Calculating value = 2.255 A , 2.255A < rating current of fuse
- ◆ Normal operating voltage : DC 12 V
- ◆ Following bottom index-table :

Suggesting use CFS06V3T2R50 .

Part Designation	Marking	Rated Current	Rated Voltage	Part Designation	Marking	Rated Current	Rated Voltage	Part Designation	Marking	Rated Current	Rated Voltage
CFS04V3TR50	F	0.5A	32V	CFS06V5TR40	E	0.40A	50V	CFS12V6TR50	F	0.50A	63V
CFS04V3TR80	K	0.80A	32V	CFS06V5TR50	F	0.5A	50V	CFS12V6TR80	K	0.80A	63V
CFS04V3T1R0	L	1.00A	32V	CFS06V3TR63	I	0.63A	32V	CFS12V6T1R0	L	1.00A	63V
CFS04V3T1R25	M	1.25A	32V	CFS06V3TR70	J	0.7A	32V	CFS12V6T1R25	M	1.25A	63V
CFS04V3T1R50	P	1.50A	32V	CFS06V3TR80	K	0.80A	32V	CFS12V6T1R50	P	1.50A	63V
CFS04V3T1R60	N	1.60A	32V	CFS06V3T1R0	L	1.00A	32V	CFS12V6T2R0	S	2.00A	63V
CFS04V3T2R0	S	2.00A	32V	CFS06V3T1R25	M	1.25A	32V	CFS12V3T2R50	T	2.50A	32V
CFS04V3T2R50	T	2.50A	32V	CFS06V3T1R50	P	1.50A	32V	CFS12V3T3R00	3	3.00A	32V
CFS04V3T3R0	3	3.00A	32V	CFS06V3T1R60	N	1.60A	32V	CFS12V3T4R0	W	4.00A	32V
CFS04V3T3R15	U	3.15A	32V	CFS06V3T2R0	S	2.00A	32V	CFS12V3T5R0	Y	5.00A	32V
CFS04V3T4R0	W	4.00A	32V	CFS06V3T2R50	T	2.50A	32V	CFS12V3T7R0	Z	7.00A	32V
				CFS06V3T3R00	3	3.00A	32V				
				CFS06V3T3R15	U	3.15A	32V				
				CFS06V3T4R0	W	4.00A	32V				
				CFS06V3T5R0	Y	5.00A	32V				
				CFS06V3T6R0	6	6.00A	32V				

■ Inrush current :

- ◆ Considering inrush waveform & calculate I^2t (A²s) value
- ◆ Choosing fuse's I^2t (A²s) value > calculate I^2t (A²s) value
- ◆ Considering Ratio of I^2t repeat numbers to blowing .
- ◆ Confirm with us.

e.g., choosing 0603 Fuse

Condition :

1. Rectangular Wave , $I_p = 4 \text{ A}$, $t = 1 \text{ (ms)}$,
 Calculate $I_p^2t = 4^2 \times 1 \times 10^{-3} = 0.016 \text{ (A}^2\text{s)}$
2. Choosing CFS06V3T2R50 ($I^2t = 0.200 \text{ (A}^2\text{s)}$) \Rightarrow Page 12 index-table
3. Inrush shock : 100,000 times (≈ 0.35) \Rightarrow Inrush derating ratio



Thin Film Chip Fuse

Document No	TCFS-XX0S004I
Issued date	2012/11/26
Page	12/20

4. Calculating :

1. Choosing fuse's I^2t (A²s) value X Derating ratio > calculate I^2t (A²s) value
2. $0.200 \times 0.35 = 0.070$ (A²s) **Inrush 100,000 times**
3. $0.070 > 0.016$

The fuse is able to meet circuit's application

TA-I FUSE I^2t (A ² s)					
Part Number	Typical I^2t (A ² s)*	Part Number	Typical I^2t (A ² s)*	Part Number	Typical I^2t (A ² s)*
CFS04V3TR50	0.00370	CFS06V5TR40	0.004	CFS12V6TR50	0.030
CFS04V3TR80	0.00947	CFS06V5TR50	0.009	CFS12V6TR80	0.068
CFS04V3T1R0	0.01479	CFS06V3TR63	0.017	CFS12V6T1R0	0.098
CFS04V3T1R25	0.02310	CFS06V3TR70	0.023	CFS12V6T1R25	0.155
CFS04V3T1R50	0.02400	CFS06V3TR80	0.024	CFS12V6T1R50	0.236
CFS04V3T1R60	0.03734	CFS06V3T1R0	0.026	CFS12V6T2R0	0.339
CFS04V3T2R0	0.04040	CFS06V3T1R25	0.057	CFS12V3T2R50	0.605
CFS04V3T2R50	0.06760	CFS06V3T1R50	0.081	CFS12V3T3R00	0.933
CFS04V3T3R0	0.09860	CFS06V3T1R60	0.086	CFS12V3T4R0	1.537
CFS04V3T3R15	0.10868	CFS06V3T2R0	0.115	CFS12V3T5R0	2.533
CFS04V3T4R0	0.11450	CFS06V3T2R50	0.200	CFS12V3T7R0	5.684
		CFS06V3T3R00	0.210		
		CFS06V3T3R15	0.279		
		CFS06V3T4R0	0.326		
		CFS06V3T5R0	0.622		
		CFS06V3T6R0	2.700		

Note*: Typical I^2t value is measured at 10x-rated current, Application with surge over 10x-rated current. Please confirm with us.

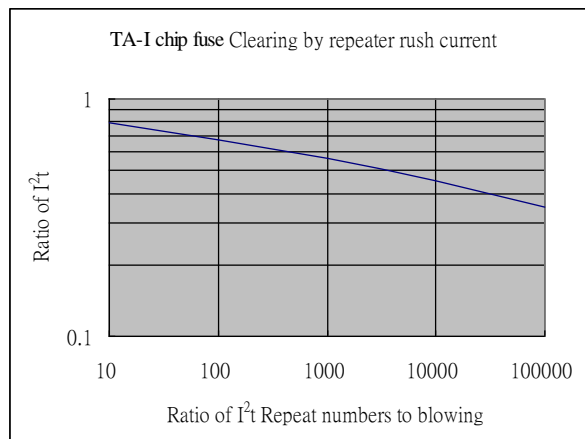



Document No	TCFS-XX0S004I
Issued date	2012/11/26
Page	13/20

Inrush Waveform

Sinusoidal waveform (1 cycle)		$\frac{1}{2} Im^2 t$
Sinusoidal waveform (1/2 cycle)		$\frac{1}{2} Im^2 t$
Triangle waveform		$\frac{1}{3} Im^2 t$
Rectangular waveform		$Im^2 t$
Trapezoidal waveform		$\frac{1}{3} Im^2 t_1 + Im^2 (t_2 - t_1) + \frac{1}{3} Im^2 (t_3 - t_2)$
Various waveform 1		$I_1 I_2 t + \frac{1}{3} (I_1 - I_2)^2 t$
Various waveform 2		$\frac{1}{3} I_1^2 t_1 + \{I_1 I_2 + \frac{1}{3} (I_1 - I_2)^2\} (t_2 - t_1) + \frac{1}{3} I_2^2 (t_3 - t_2)$
Charge/Discharge waveform		$\frac{1}{2} Im^2 \tau$
Lightning surge waveform		$Im^2 \{t_1/3 + 0.721 (t_2 - t_1)\}$

t_1 : duration of wave front
 t_2 : duration of wave tail



Thin Film Chip Fuse

Document No	TCFS-XX0S004I
Issued date	2012/11/26
Page	14/20





Document No	TCFS-XX0S004I
Issued date	2012/11/26
Page	15/20

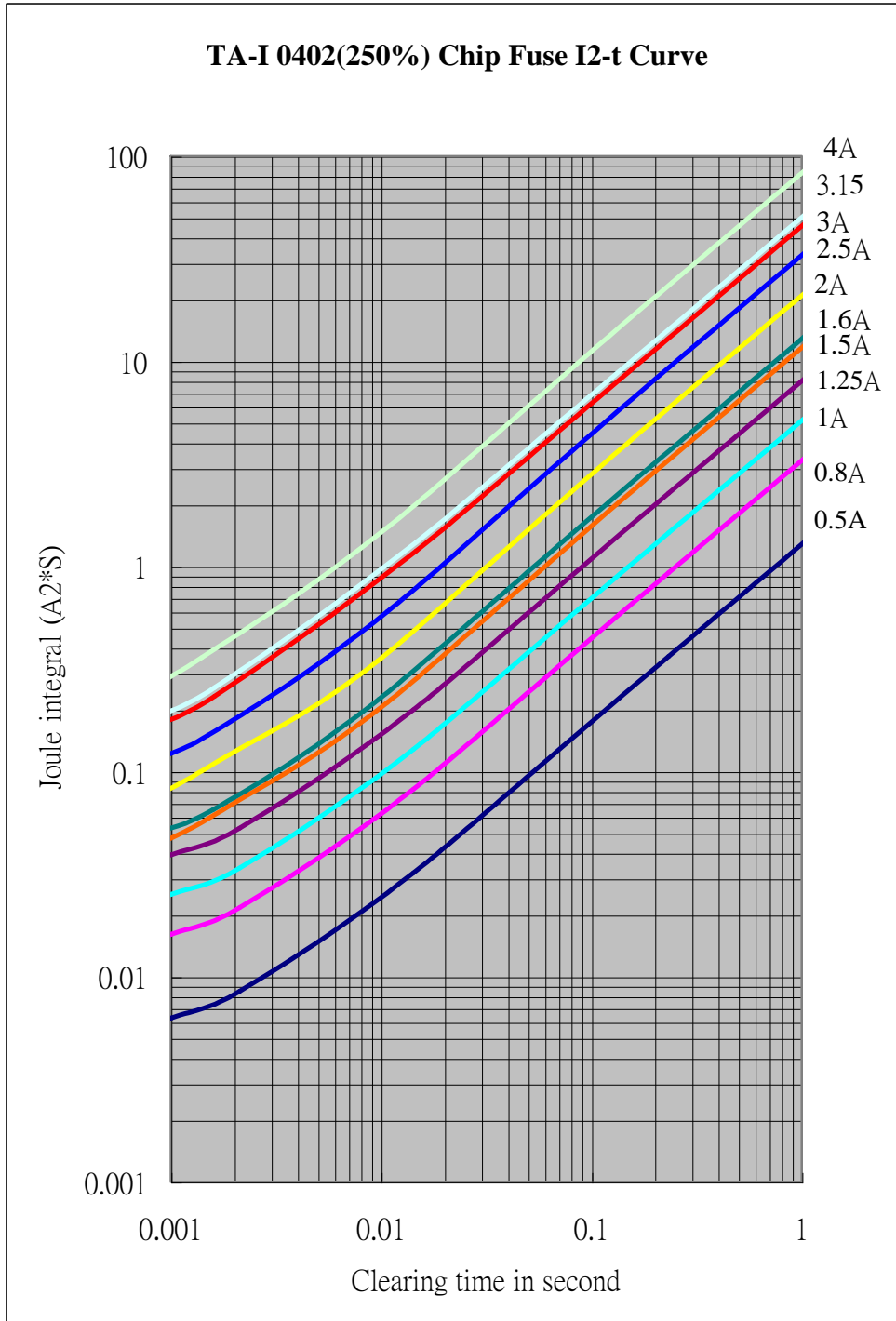



Document No	TCFS-XX0S004I
Issued date	2012/11/26
Page	16/20

TA-I 0603 (250%) Chip Fuse I-t Curve

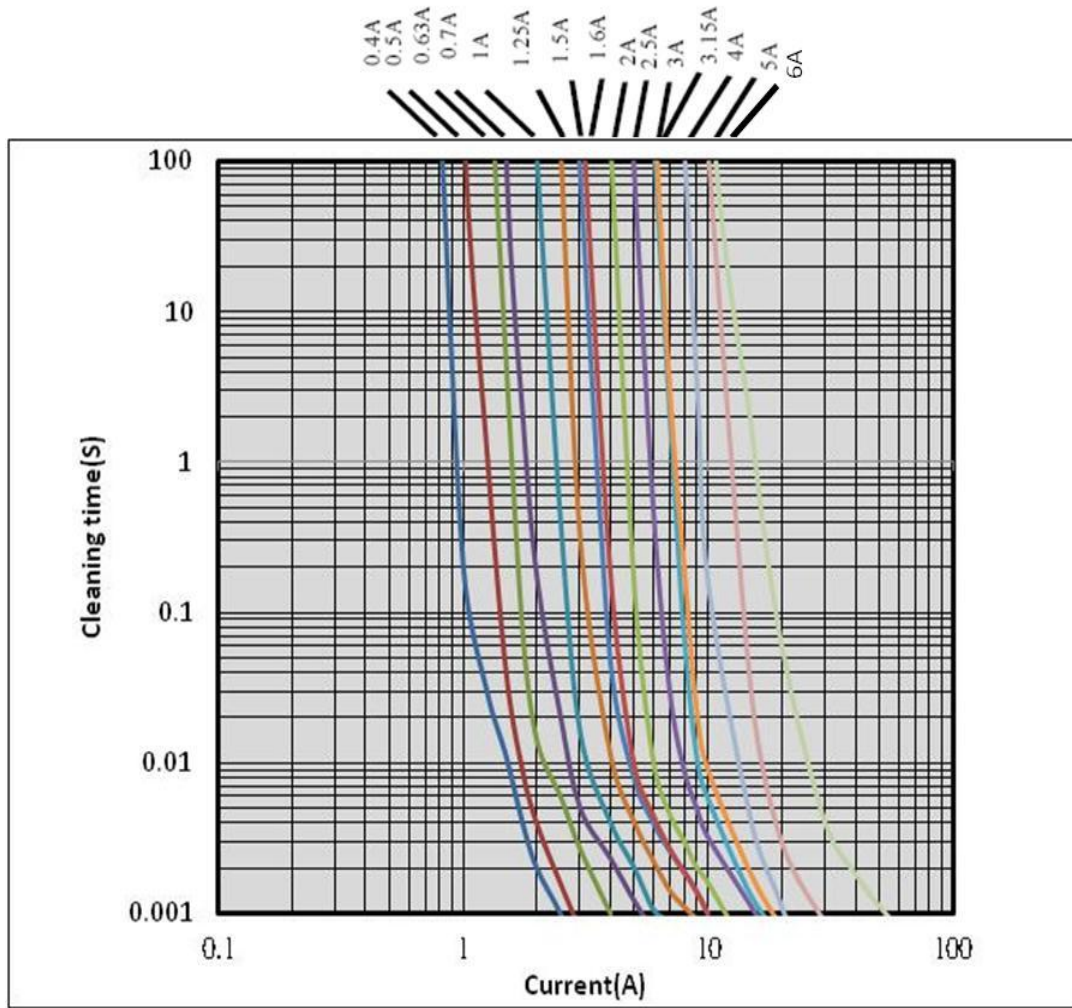



Thin Film Chip Fuse

Document No	TCFS-XX0S004I
Issued date	2012/11/26
Page	17/20

TA-I 0603 (250%) Chip Fuse I²-t Curve

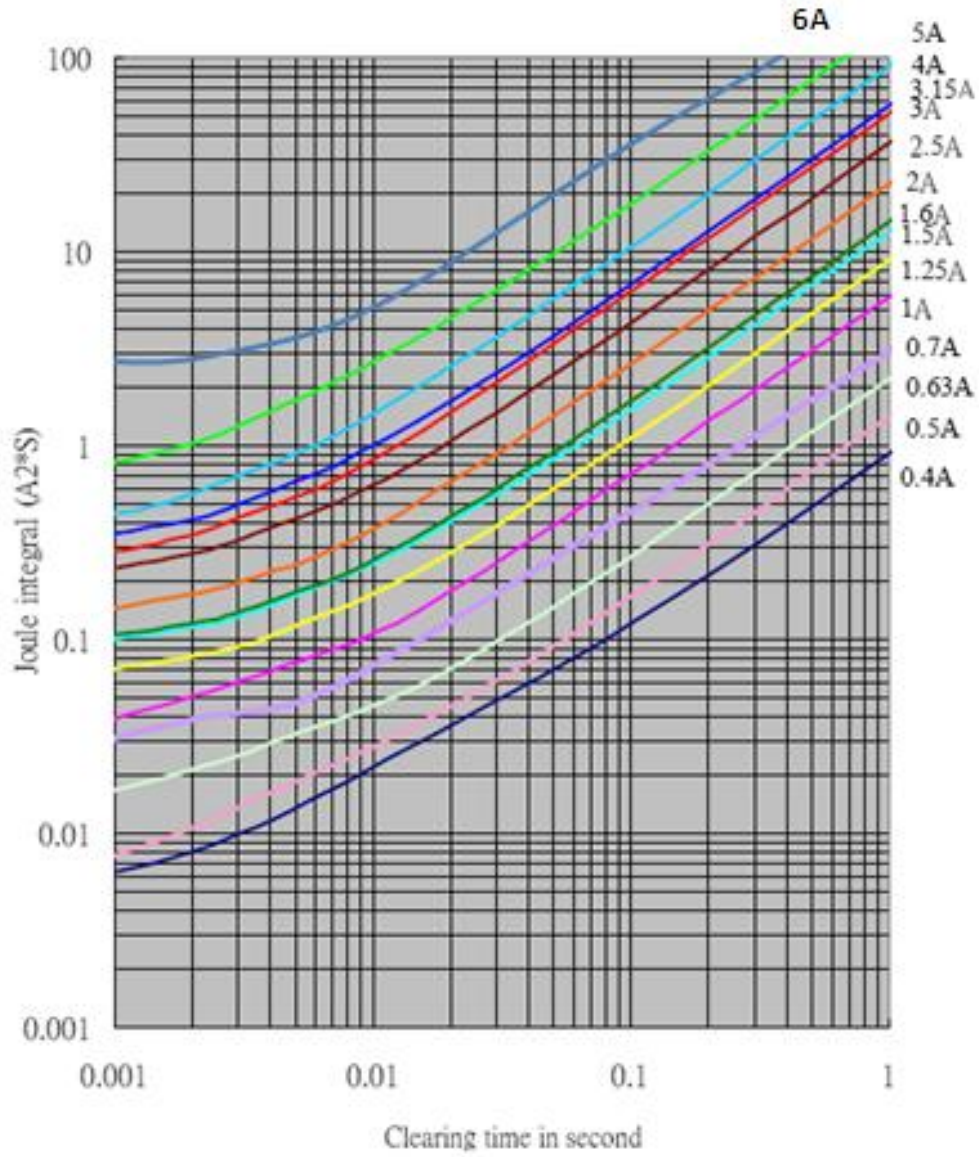



Thin Film Chip Fuse

Document No	TCFS-XX0S004I
Issued date	2012/11/26
Page	18/20





Thin Film Chip Fuse

Document No	TCFS-XX0S004I
Issued date	2012/11/26
Page	19/20

TA-I 1206(250%) Chip Fuse I²-t Curve

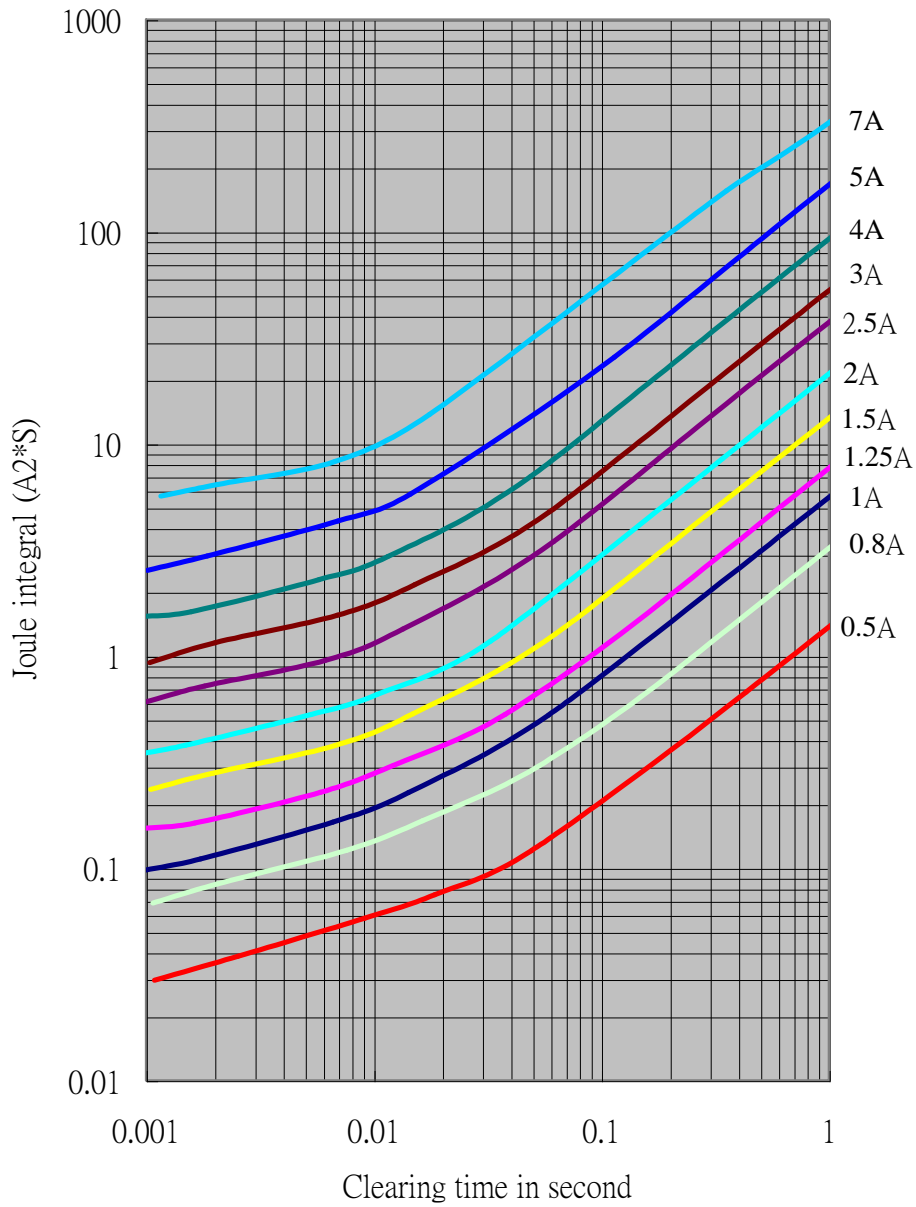



Thin Film Chip Fuse

Document No	TCFS-XX0S004I
Issued date	2012/11/26
Page	20/20

Test Circuit Board

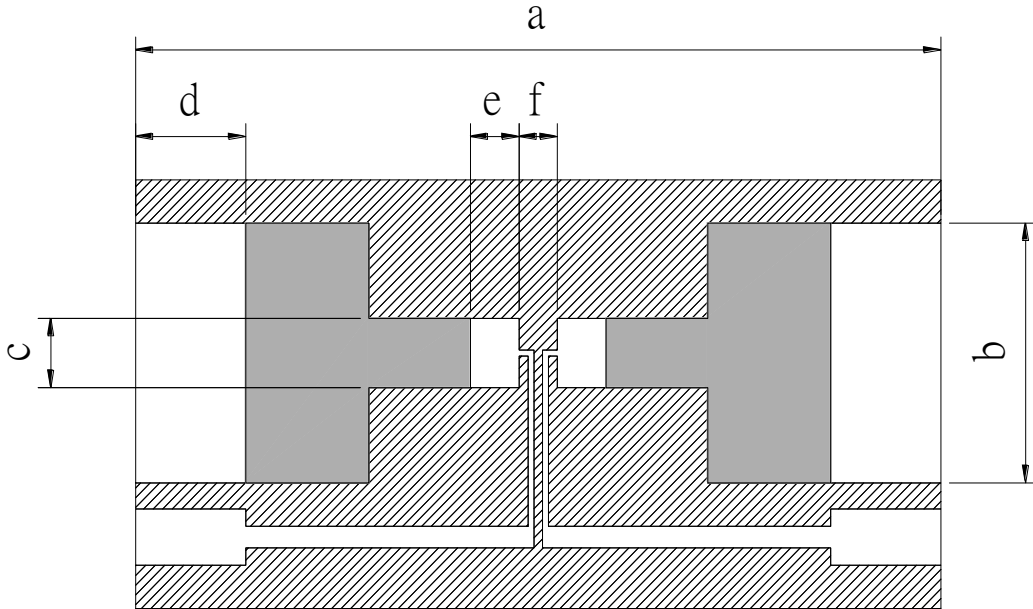

Type	a	b	c	d	e	f
CFS0402	19	6	0.84	2.6	0.61	0.6
CFS0603	19	6	1.60	2.6	1.15	0.9
CFS1206	19	6	2.40	2.6	1.90	1.0

Unit: mm