

## 180 mA Low-Noise LDO Regulator

### Features

- Output Voltage Range: 1.8V – 15V
- Ultra-Low-Noise Output
- High Output Voltage Accuracy
- Guaranteed 180 mA Output
- Low Quiescent Current
- Low Dropout Voltage
- Extremely Tight Load and Line Regulation
- Very Low Temperature Coefficient
- Current and Thermal Limiting
- Reversed-Battery Protection
- “Zero” Off-Mode Current
- Logic-Controlled Electronic Enable

### Applications

- Cellular Telephones
- Laptop, Notebook, and Palmtop Computers
- Battery Powered Equipment
- PCMCIA  $V_{CC}$  and  $V_{PP}$  Regulation/Switching
- Consumer/Personal Electronics
- SMPS Post-Regulator and DC/DC Modules
- High-Efficiency Linear Power Supplies

### General Description

The MIC5207 is an efficient linear voltage regulator with ultra-low-noise output, very low dropout voltage (typically 17 mV at light loads and 165 mV at 150 mA), and very low ground current (720  $\mu$ A at 100 mA output). The MIC5207 offers better than 3% initial accuracy.

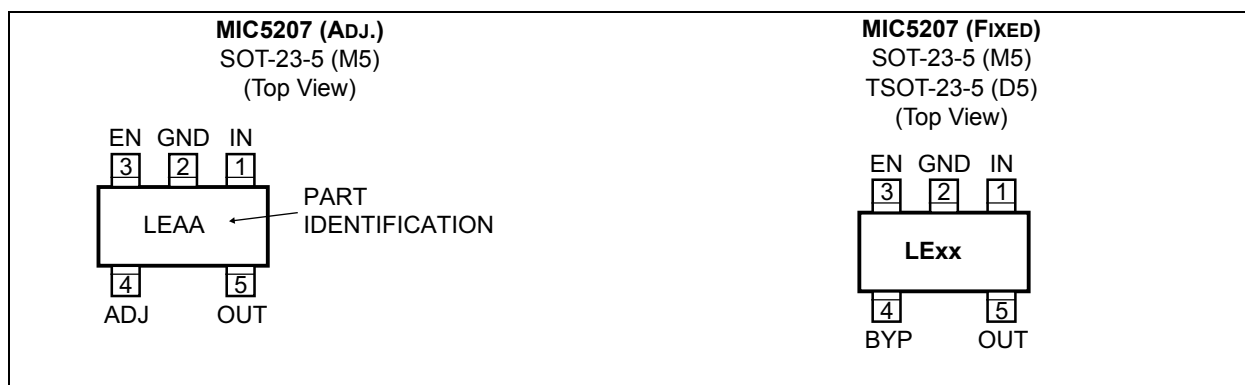
Designed especially for hand-held, battery-powered devices, the MIC5207 includes a CMOS or TTL compatible enable/shutdown control input. When in shutdown, power consumption drops nearly to zero.

Key MIC5207 features include a reference bypass pin to improve its already low-noise performance, reversed-battery protection, current limiting, and over temperature shutdown.

The MIC5207 is available in fixed and adjustable output voltage versions in a small SOT-23-5 package. Contact Microchip for details.

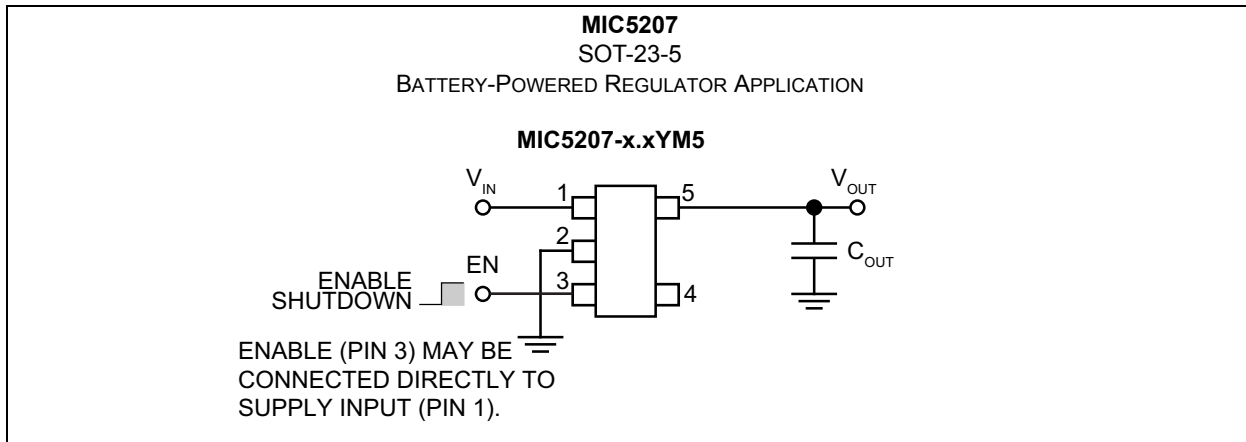
For low-dropout regulators that are stable with ceramic output capacitors, see the  $\mu$ Cap MIC5245/6/7 family.

### Package Types

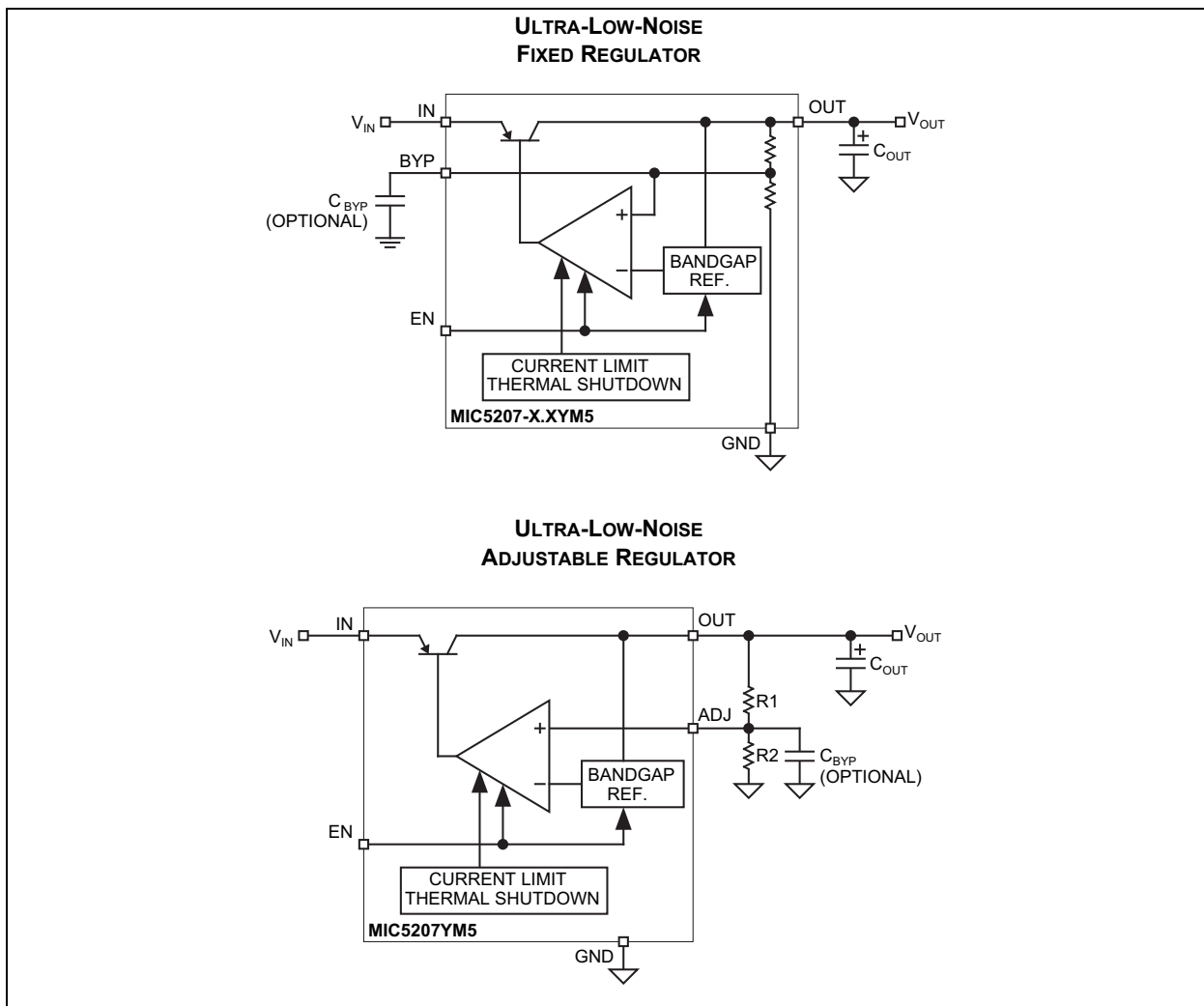


# MIC5207

## Typical Application Circuit



## Functional Diagrams



## 1.0 ELECTRICAL CHARACTERISTICS

### Absolute Maximum Ratings †

Supply Input Voltage ( $V_{IN}$ ) .....	-20V to +20V
Enable Input Voltage ( $V_{EN}$ ) .....	-20V to +20V
Power Dissipation ( $P_D$ ) (Note 1) .....	Internally Limited

### Operating Ratings ‡

Supply Input Voltage ( $V_{IN}$ ) .....	+2.5V to +16V
Adjustable Output Voltage Range ( $V_{OUT}$ ) .....	+1.8V to +15V
Enable Input Voltage ( $V_{EN}$ ) .....	.0V to $V_{IN}$

† **Notice:** Stresses above those listed under “Absolute Maximum Ratings” may cause permanent damage to the device. This is a stress rating only and functional operation of the device at those or any other conditions above those indicated in the operational sections of this specification is not intended. Exposure to maximum rating conditions for extended periods may affect device reliability.

‡ **Notice:** The device is not guaranteed to function outside its operating ratings.

**Note 1:** The maximum allowable power dissipation at any  $T_A$  (ambient temperature) is  $P_{D(max)} = (T_{J(max)} - T_A) / \theta_{JA}$ . Exceeding the maximum allowable power dissipation will cause excessive die temperature, and the regulator will go into thermal shutdown. The  $\theta_{JA}$  of the SOT-23-5 (M5) is 235°C/W soldered on a PC board (see “Thermal Considerations” for further details).

# MIC5207

**TABLE 1-1: ELECTRICAL CHARACTERISTICS (Note 1)**

**Electrical Characteristics:**  $V_{IN} = V_{OUT} + 1V$ ;  $I_L = 100 \mu A$ ;  $C_L = 1.0 \mu F$ ;  $V_{EN} \geq 2.0V$ ;  $T_J = +25^\circ C$ , **bold** values indicate  $-40^\circ C \leq T_J \leq +125^\circ C$  except  $0^\circ C < T_J < +125^\circ C$  for 1.8V; unless noted.

Parameter	Symbol	Min.	Typ.	Max.	Units	Conditions
Output Voltage Accuracy	$V_O$	-3	—	3	%	Variation from nominal $V_{OUT}$
		-4	—	4		
Output Voltage Temperature Coefficient	$\Delta V_O / \Delta T$	—	<b>40</b>	—	ppm/ $^\circ C$	Note 2
Line Regulation	$\Delta V_O / V_O$	—	0.005	0.05	%	$V_{IN} = V_{OUT} + 1V$ to 16V
		—	—	<b>0.10</b>		
Load Regulation	$\Delta V_O / V_O$	—	0.05	0.5	%	$I_L = 0.1$ mA to 150 mA, Note 3
		—	—	<b>0.7</b>		
Dropout Voltage, Note 4	$V_{IN} - V_O$	—	17	60	mV	$I_L = 100 \mu A$
		—	—	<b>80</b>		
		—	115	175		$I_L = 50$ mA
		—	—	<b>250</b>		
		—	140	280		$I_L = 100$ mA
		—	—	<b>325</b>		
		—	165	300		
—	—	<b>400</b>	$I_L = 150$ mA			
Quiescent Current	$I_{GND}$	—	0.01	1	$\mu A$	$V_{EN} \leq 0.4V$ (shutdown)
		—	—	<b>5</b>		$V_{EN} \leq 0.18V$ (shutdown)
Ground Pin Current (Note 5)	$I_{GND}$	—	80	130	$\mu A$	$V_{EN} \geq 2.0V$ , $I_L = 100 \mu A$
		—	—	<b>170</b>		
		—	350	650		$I_L = 50$ mA
		—	—	<b>900</b>		
		—	720	1100		$I_L = 100$ mA
		—	—	<b>2000</b>		
		—	1800	2500		
—	—	<b>3000</b>	$I_L = 150$ mA			
Ripple Rejection	PSRR	—	75	—	dB	—
Current Limit	$I_{LIMIT}$	—	320	500	mA	$V_{OUT} = 0V$
Thermal Regulation	$\Delta V_O / \Delta P_D$	—	0.05	—	%/W	Note 6
Output Noise	$e_n$	—	100	—	$\mu V$	—

**TABLE 1-1: ELECTRICAL CHARACTERISTICS (Note 1) (CONTINUED)**

**Electrical Characteristics:**  $V_{IN} = V_{OUT} + 1V$ ;  $I_L = 100 \mu A$ ;  $C_L = 1.0 \mu F$ ;  $V_{EN} \geq 2.0V$ ;  $T_J = +25^\circ C$ , **bold** values indicate  $-40^\circ C \leq T_J \leq +125^\circ C$  except  $0^\circ C < T_J < +125^\circ C$  for 1.8V; unless noted.

Parameter	Symbol	Min.	Typ.	Max.	Units	Conditions
<b>Enable Input</b>						
Enable Input Logic-Low Voltage	$V_{IL}$	—	—	0.4	V	Regulator shutdown
		—	—	<b>0.18</b>		
Enable Input Logic-High Voltage	$V_{IH}$	<b>2.0</b>	—	—	V	Regulator enable
Enable Input Current	$I_{IL}$	—	0.01	-1	$\mu A$	$V_{IL} \leq 0.4V$
		—	—	<b>-2</b>		$V_{IL} \leq 0.18V$
	$I_{IH}$	—	5	20		$V_{IH} \geq 2.0V$
		—	—	<b>25</b>		$V_{IH} \geq 2.0V$

**Note 1:** Specification for packaged product only.

- 2:** Output voltage temperature coefficient is defined as the worst-case voltage change divided by the total temperature range.
- 3:** Regulation is measured at constant junction temperature using low duty cycle pulse testing. Parts are tested for load regulation in the load range from 0.1 mA to 180 mA. Changes in output voltage due to heating effects are covered by the thermal regulation specification.
- 4:** Dropout Voltage is defined as the input to output differential at which the output voltage drops 2% below its nominal value measured at 1V differential.
- 5:** Ground pin current is the regulator quiescent current plus pass transistor base current. The total current drawn from the supply is the sum of the load current plus the ground pin current.
- 6:** Thermal regulation is defined as the change in output voltage at a time "t" after a change in power dissipation is applied, excluding load or line regulation effects. Specifications are for a 180 mA load pulse at  $V_{IN} = 16V$  for  $t = 10$  ms.

# MIC5207

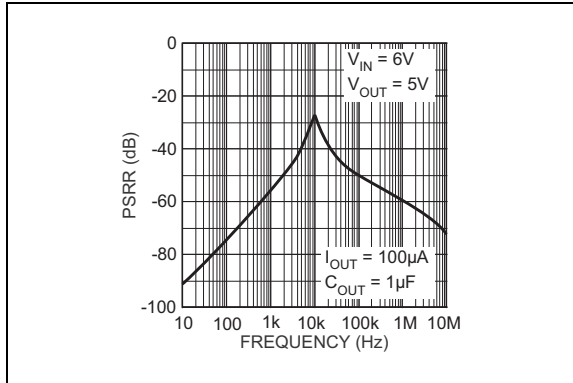
## TEMPERATURE SPECIFICATIONS (Note 1)

Parameters	Sym.	Min.	Typ.	Max.	Units	Conditions
<b>Temperature Ranges</b>						
Storage Temperature Range	$T_S$	-65	—	+150	°C	—
Lead Temperature	—	—	—	+260	°C	Soldering, 5 sec.
Junction Temperature ( $2.5 \leq V_{OUT} \leq 15V$ )	$T_J$	-40	—	+125	°C	All, except 1.8V
Junction Temperature ( $1.8V \leq V_{OUT} < 2.5V$ )	$T_J$	0	—	+125	°C	1.8V only
<b>Package Thermal Resistance</b>						
Thermal Resistance SOT-23	$\theta_{JA}$	—	235	—	°C/W	—
	$\theta_{JC}$	—	130	—		—

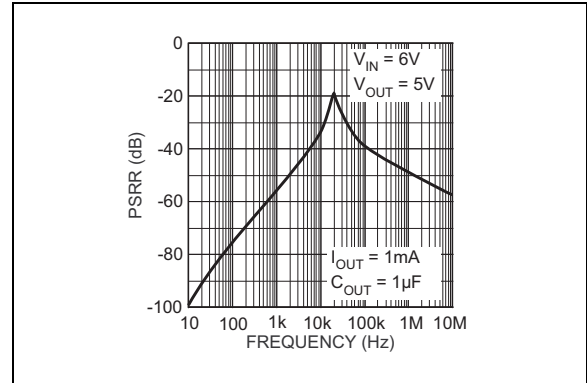
**Note 1:** The maximum allowable power dissipation is a function of ambient temperature, the maximum allowable junction temperature and the thermal resistance from junction to air (i.e.,  $T_A$ ,  $T_J$ ,  $\theta_{JA}$ ). Exceeding the maximum allowable power dissipation will cause the device operating junction temperature to exceed the maximum +125°C rating. Sustained junction temperatures above +125°C can impact the device reliability.

## 2.0 TYPICAL PERFORMANCE CURVES

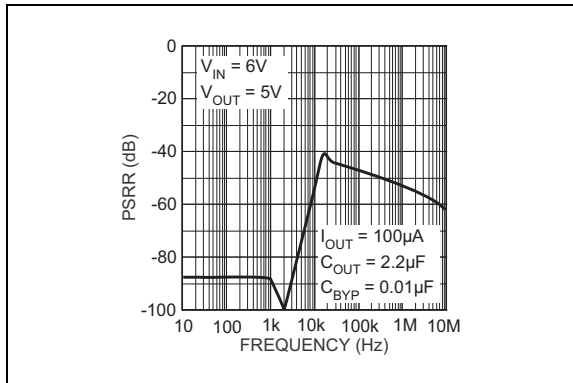
**Note:** The graphs and tables provided following this note are a statistical summary based on a limited number of samples and are provided for informational purposes only. The performance characteristics listed herein are not tested or guaranteed. In some graphs or tables, the data presented may be outside the specified operating range (e.g., outside specified power supply range) and therefore outside the warranted range.



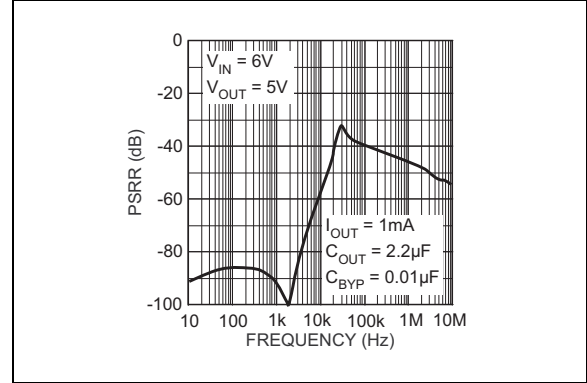
**FIGURE 2-1:** Power Supply Rejection Ratio.



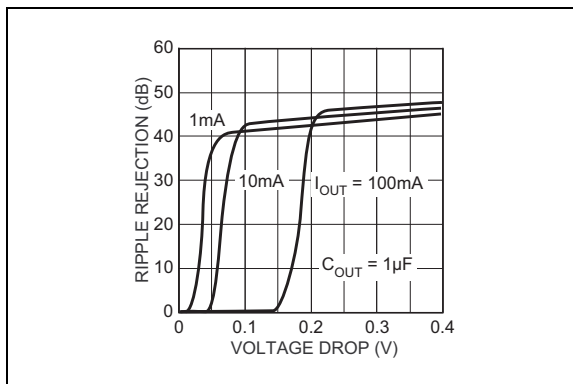
**FIGURE 2-4:** Power Supply Rejection Ratio.



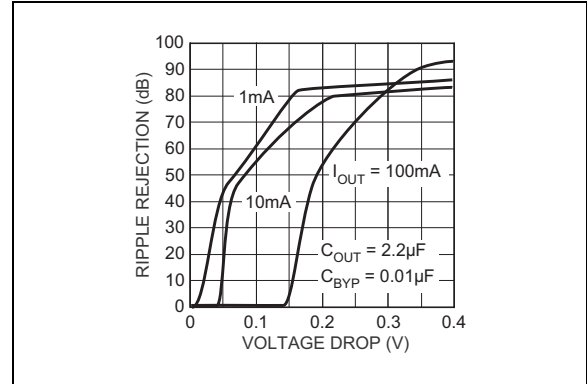
**FIGURE 2-2:** Power Supply Rejection Ratio.



**FIGURE 2-5:** Power Supply Rejection Ratio.

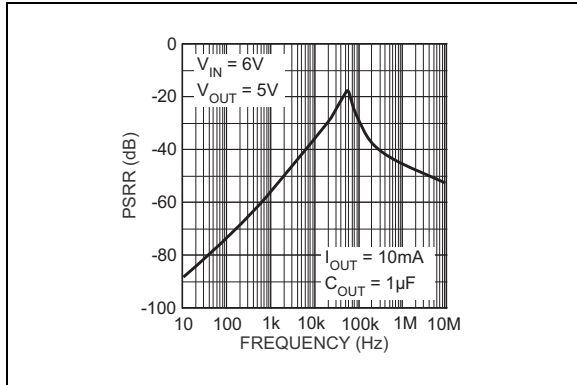


**FIGURE 2-3:** Power Supply Ripple Rejection vs. Voltage Drop.

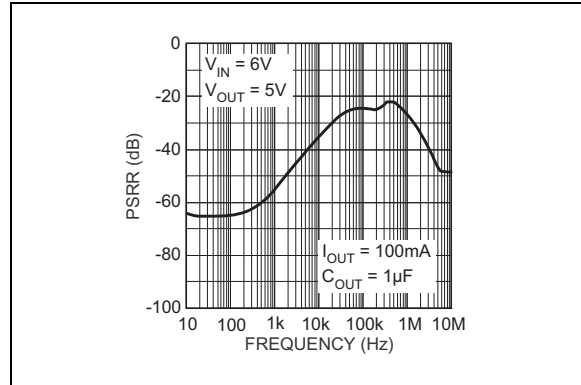


**FIGURE 2-6:** Power Supply Ripple Rejection vs. Voltage Drop.

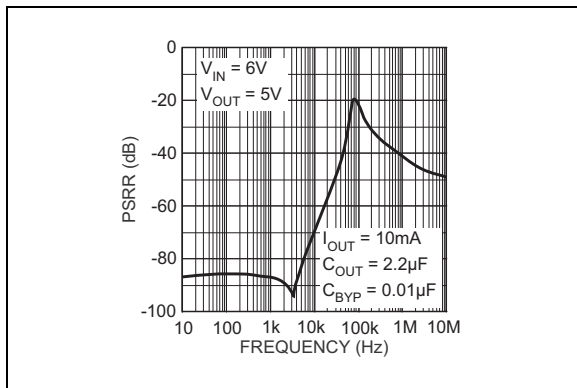
# MIC5207



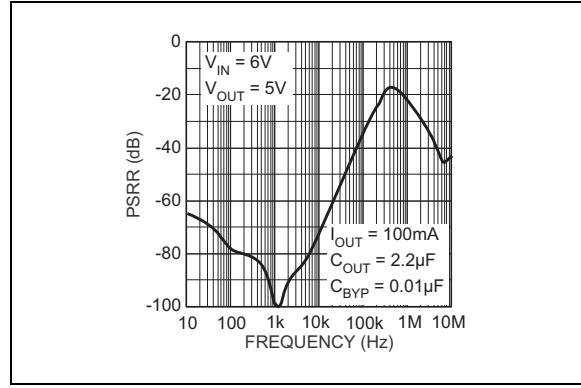
**FIGURE 2-7:** Power Supply Rejection Ratio.



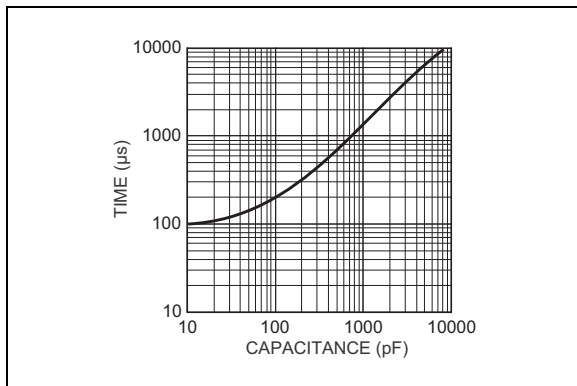
**FIGURE 2-10:** Power Supply Rejection Ratio.



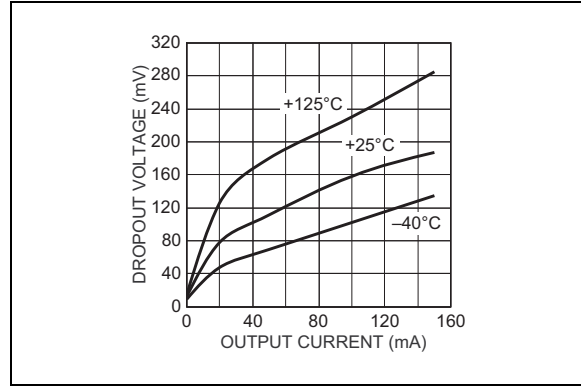
**FIGURE 2-8:** Power Supply Rejection Ratio.



**FIGURE 2-11:** Power Supply Rejection Ratio.

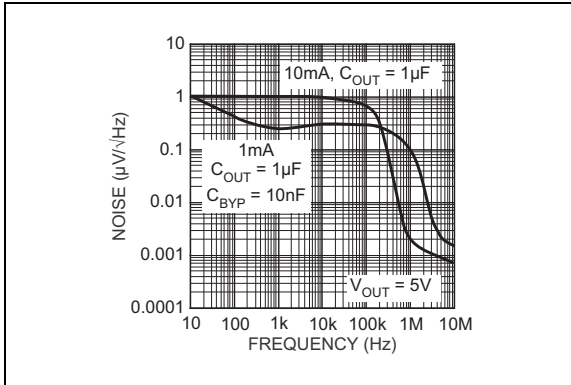


**FIGURE 2-9:** Turn-On Time vs. Bypass Capacitance.

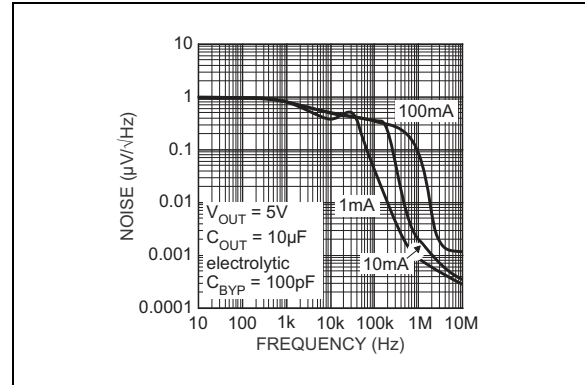


**FIGURE 2-12:** Dropout Voltage vs. Output Current.

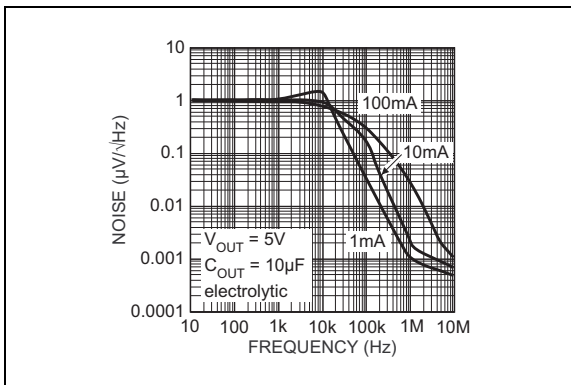




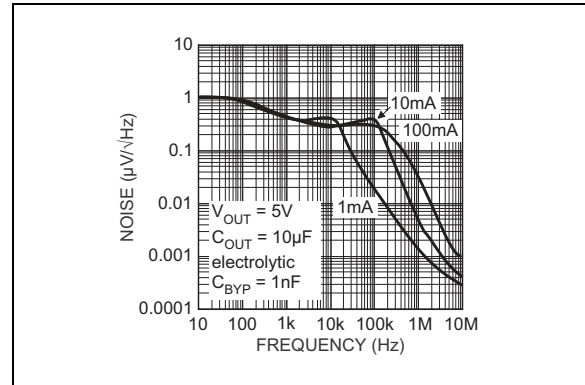
**FIGURE 2-13:** Noise Performance.



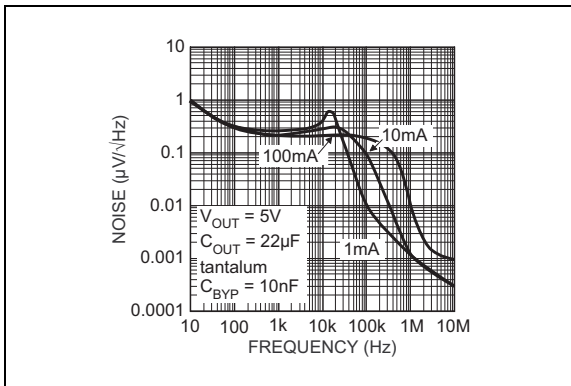
**FIGURE 2-16:** Noise Performance.



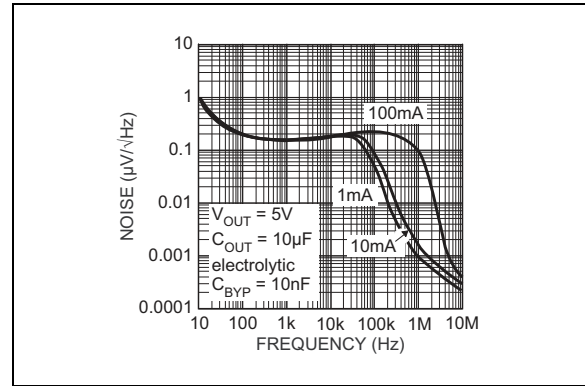
**FIGURE 2-14:** Noise Performance.



**FIGURE 2-17:** Noise Performance.



**FIGURE 2-15:** Noise Performance.



**FIGURE 2-18:** Noise Performance.

# MIC5207

---

## 3.0 PIN DESCRIPTIONS

The descriptions of the pins are listed in [Table 3-1](#).

**TABLE 3-1: PIN FUNCTION TABLE**

Pin Number	Pin Name	Description
1	IN	Supply input.
2	GND	Ground.
3	EN	Enable/Shutdown (Input): CMOS-compatible input. Logic-high = enable, logic-low = shutdown. Do not leave floating.
4 (Fixed)	BYP	Reference Bypass: Connect external 470 pF capacitor to GND to reduce output noise. May be left open. For 1.8V or 2.5V operation, see <a href="#">Applications Information</a> section.
4 (Adj.)	ADJ	Adjust (Input): Adjustable regulator feedback input. Connect to resistor voltage divider.
5	OUT	Regulator output.

## 4.0 APPLICATIONS INFORMATION

### 4.1 Enable/Shutdown

Forcing EN (enable/shutdown) high (> 2V) enables the regulator. EN is compatible with CMOS logic gates.

If the enable/shutdown feature is not required, connect EN (pin 3) to IN (supply input, pin 1). See [Figure 4-1](#).

### 4.2 Input Capacitor

A 1  $\mu\text{F}$  capacitor should be placed from IN to GND if there is more than 10 inches of wire between the input and the AC filter capacitor or if a battery is used as the input.

### 4.3 Reference Bypass Capacitor

Reference bypass (BYP) is connected to the internal voltage reference. A 470 pF capacitor ( $C_{\text{BYP}}$ ) connected from BYP to GND quiets this reference, providing a significant reduction in output noise.  $C_{\text{BYP}}$  reduces the regulator phase margin; when using  $C_{\text{BYP}}$ , output capacitors of 2.2  $\mu\text{F}$  or greater are generally required to maintain stability.

The start-up speed of the MIC5207 is inversely proportional to the size of the reference bypass capacitor. Applications requiring a slow ramp-up of output voltage should consider larger values of  $C_{\text{BYP}}$ . Likewise, if rapid turn-on is necessary, consider omitting  $C_{\text{BYP}}$ .

If output noise is not a major concern, omit  $C_{\text{BYP}}$  and leave BYP open.

### 4.4 Output Capacitor

An output capacitor is required between OUT and GND to prevent oscillation. The minimum size of the output capacitor is dependent upon whether a reference bypass capacitor is used. 1.0  $\mu\text{F}$  minimum is recommended when  $C_{\text{BYP}}$  is not used (see [Figure 4-2](#)). 2.2  $\mu\text{F}$  minimum is recommended when  $C_{\text{BYP}}$  is 470 pF (see [Figure 4-1](#)). Larger values improve the regulator's transient response. The output capacitor value may be increased without limit.

The output capacitor should have an ESR (effective series resistance) of about 5 $\Omega$  or less and a resonant frequency above 1 MHz. Ultra-low-ESR (ceramic) capacitors can cause a low amplitude oscillation on the output and/or under-damped transient response. Most tantalum or aluminum electrolytic capacitors are adequate; film types will work, but are more expensive. Since many aluminum electrolytics have electrolytes that freeze at about  $-30^{\circ}\text{C}$ , solid tantalums are recommended for operation below  $-25^{\circ}\text{C}$ .

At lower values of output current, less output capacitance is required for output stability. The capacitor can be reduced to 0.47  $\mu\text{F}$  for current below 10 mA or 0.33  $\mu\text{F}$  for currents below 1 mA.

### 4.5 No-Load Stability

The MIC5207 will remain stable and in regulation with no load (other than the internal voltage divider) unlike many other voltage regulators. This is especially important in CMOSRAM keep-alive applications.

### 4.6 Thermal Considerations

The MIC5207 is designed to provide 180 mA of continuous current in a very small package. Maximum power dissipation can be calculated based on the output current and the voltage drop across the part. To determine the maximum power dissipation of the package, use the junction-to-ambient thermal resistance of the device and the following basic equation shown in [Equation 4-1](#):

#### EQUATION 4-1:

$$P_{D(\text{MAX})} = \frac{(T_{J(\text{MAX})} - T_A)}{\theta_{JA}}$$

$T_{J(\text{MAX})}$  is the maximum junction temperature of the die,  $+125^{\circ}\text{C}$ , and  $T_A$  is the ambient operating temperature.  $\theta_{JA}$  is layout dependent; [Table 4-1](#) shows examples of junction-to-ambient thermal resistance for the MIC5207.

**TABLE 4-1: SOT-23-5 THERMAL RESISTANCE**

$\theta_{JA}$ Rec. Min. Footprint	$\theta_{JA}$ 1" Square Copper Clad	$\theta_{JC}$
235 $^{\circ}\text{C}/\text{W}$	170 $^{\circ}\text{C}/\text{W}$	130 $^{\circ}\text{C}/\text{W}$

The actual power dissipation of the regulator circuit can be determined using [Equation 4-2](#):

#### EQUATION 4-2:

$$P_D = (V_{IN} - V_{OUT}) \times I_{OUT} + V_{IN} \times I_{GND}$$

Substituting  $P_{D(\text{MAX})}$  for  $P_D$  and solving for the operating conditions that are critical to the application will give the maximum operating conditions for the regulator circuit. For example, when operating the

# MIC5207

MIC5207-3.3YM5 at room temperature with a minimum footprint layout, the maximum input voltage for a set output current can be determined with [Equation 4-3](#):

## EQUATION 4-3:

$$P_{D(MAX)} = \frac{125^{\circ}C - 25^{\circ}C}{235^{\circ}C/W} = 425mW$$

The junction-to-ambient thermal resistance for the minimum footprint is 235°C/W, from [Table 4-1](#). The maximum power dissipation must not be exceeded for proper operation. Using the output voltage of 3.3V and an output current of 150 mA, the maximum input voltage can be determined. From [Table 1-1](#), the maximum ground current for 150 mA output current is 3000 µA or 3 mA.

## EQUATION 4-4:

$$425mW = (V_{IN} - 3.3V) \times 150mA + V_{IN} \times 3mA$$

Where:

## EQUATION 4-5:

$$425mW = V_{IN} \times 150mA - 495mW + V_{IN} \times 3mA$$

Then:

## EQUATION 4-6:

$$920mW = V_{IN} \times 153mA$$

Resulting in:

## EQUATION 4-7:

$$V_{IN(MAX)} = 6.01V$$

Therefore, a 3.3V application at 150 mA of output current can accept a maximum input voltage of 6V in a SOT-23-5 package. For a full discussion of heat sinking and thermal effects on voltage regulators, refer to the Regulator Thermals section of Microchip's [Designing with Low-Dropout Voltage Regulators](#) handbook.

## 4.7 Low-Voltage Operation

The MIC5207-1.8 and MIC5207-2.5 require special consideration when used in voltage-sensitive systems. They may momentarily overshoot their nominal output voltages unless appropriate output and bypass capacitor values are chosen.

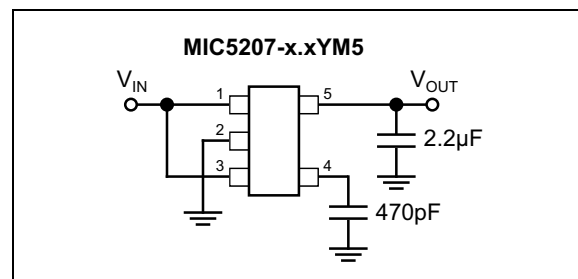
During regulator power up, the pass transistor is fully saturated for a short time, while the error amplifier and voltage reference are being powered up more slowly from the output (see [Functional Diagrams](#)). Selecting larger output and bypass capacitors allows additional time for the error amplifier and reference to turn on and prevent overshoot.

To ensure that no overshoot is present when starting up into a light load (100 µA), use a 4.7 µF output capacitance and 470 pF bypass capacitance. This slows the turn-on enough to allow the regulator to react and keep the output voltage from exceeding its nominal value. At heavier loads, use a 10 µF output capacitance and 470 pF bypass capacitance. Lower values of output and bypass capacitance can be used, depending on the sensitivity of the system.

Applications that can withstand some overshoot on the output of the regulator can reduce the output capacitor and/or reduce or eliminate the bypass capacitor. Applications that are not sensitive to overshoot due to power-on reset delays can use normal output and bypass capacitor configurations.

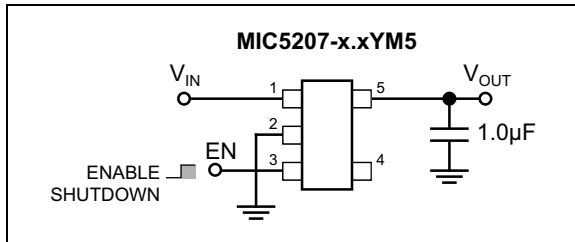
Please note the junction temperature range of the regulator with an output less than 2.5V fixed and adjustable is 0°C to +125°C.

## 4.8 Fixed Regulator Applications



**FIGURE 4-1:** Ultra-Low-Noise Fixed-Voltage Application.

Figure 4-1 includes a 470 pF capacitor for ultra-low-noise operation and shows EN (pin 3) connected to IN (pin 1) for an application where enable/shutdown is not required.  $C_{OUT} = 2.2 \mu\text{F}$  minimum.



**FIGURE 4-2:** Low-Noise Fixed-Voltage Application.

Figure 4-2 is an example of a basic low-noise configuration.  $C_{OUT} = 1 \mu\text{F}$  minimum.

## 4.9 Adjustable Regulator Applications

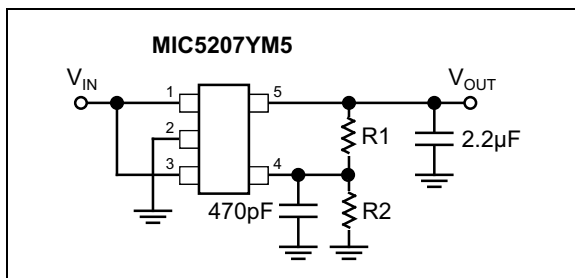
The MIC5207YM5 can be adjusted to a specific output voltage by using two external resistors (Figure 4-3). The resistors set the output voltage based on Equation 4-8:

### EQUATION 4-8:

$$V_{OUT} = V_{REF} \times \left(1 + \frac{R2}{R1}\right) = 1.242 V$$

This equation is correct due to the configuration of the bandgap reference. The bandgap voltage is relative to the output, as seen in the Functional Diagrams. Traditional regulators normally have the reference voltage relative to ground; therefore, their equations are different from the equation for the MIC5207YM5.

Resistor values are not critical because ADJ (adjust) has a high input impedance, but for best results use resistors of 470 kΩ or less. A capacitor from ADJ to ground provides greatly improved noise performance.



**FIGURE 4-3:** Ultra-Low-Noise Adjustable-Voltage Application.

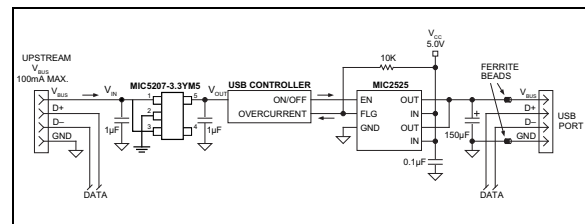
Figure 4-3 includes the optional 470 pF noise bypass capacitor from ADJ to GND to reduce output noise.

## 4.10 Dual-Supply Operation

When used in dual-supply systems where the regulator load is returned to a negative supply, the output voltage must be diode clamped to ground.

## 4.11 USB Application

Figure 4-4 shows the MIC5207-3.3YM5 in a USB application. Because the  $V_{BUS}$  supply may be greater than 10 inches from the regulator, a 1 μF input capacitor is included.



**FIGURE 4-4:** Single-Port Self-Powered Hub.

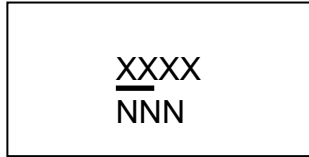
# MIC5207

---

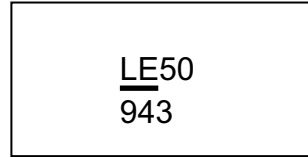
## 5.0 PACKAGING INFORMATION

### 5.1 Package Marking Information

5-Pin SOT-23\*



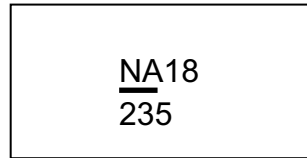
Example



5-Pin TSOT\*



Example



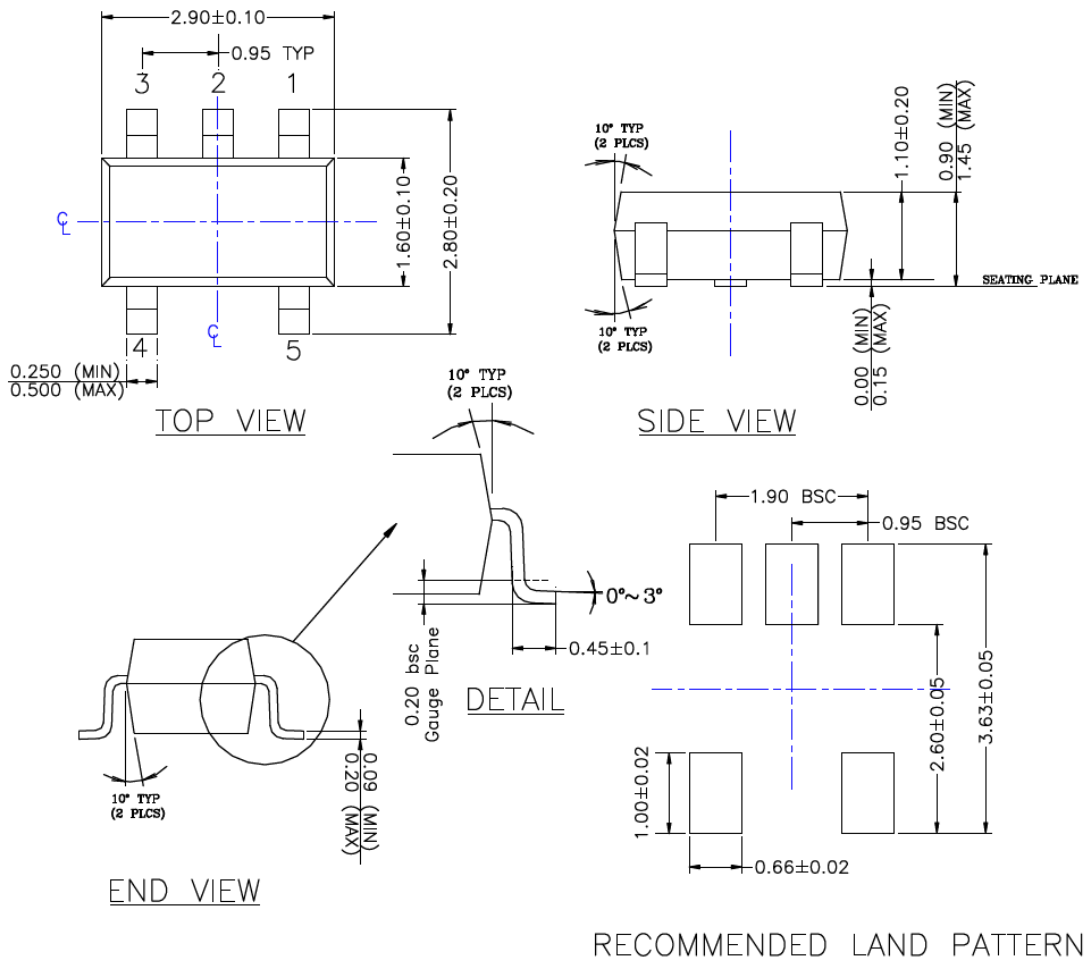
<p><b>Legend:</b> XX...X Product code or customer-specific information Y Year code (last digit of calendar year) YY Year code (last 2 digits of calendar year) WW Week code (week of January 1 is week '01') NNN Alphanumeric traceability code ⓔ3 Pb-free JEDEC® designator for Matte Tin (Sn) * This package is Pb-free. The Pb-free JEDEC designator (ⓔ3) can be found on the outer packaging for this package.</p> <p>•, ▲, ▼ Pin one index is identified by a dot, delta up, or delta down (triangle mark).</p>
<p><b>Note:</b> In the event the full Microchip part number cannot be marked on one line, it will be carried over to the next line, thus limiting the number of available characters for customer-specific information. Package may or may not include the corporate logo.</p> <p>Underbar ( ) and/or Overbar ( ) symbol may not be to scale.</p>

## 5-Lead SOT-23 Package Outline and Recommended Land Pattern

**TITLE**

5 LEAD SOT23 PACKAGE OUTLINE & RECOMMENDED LAND PATTERN

<b>DRAWING #</b>	SOT23-5LD-PL-1	<b>UNIT</b>	MM
------------------	----------------	-------------	----



**NOTE:**

1. PACKAGE OUTLINE EXCLUSIVE OF MOLD FLASH & BURR.
2. PACKAGE OUTLINE INCLUSIVE OF SOLER PLATING.
3. DIMENSION AND TOLERANCE PER ANSI Y14.5M, 1982.
4. FOOT LENGTH MEASUREMENT BASED ON GAUGE PLANE METHOD.
5. DIE FACES UP FOR MOLD, AND FACES DOWN FOR TRIM/FORM.
6. ALL DIMENSIONS ARE IN MILLIMETERS.

Note: For the most current package drawings, please see the Microchip Packaging Specification located at <http://www.microchip.com/packaging>.

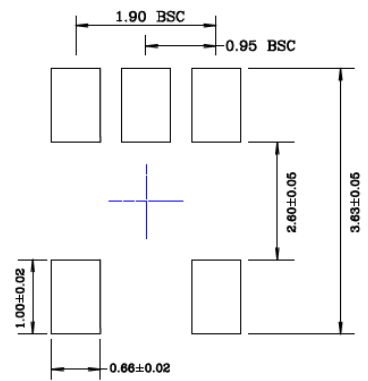
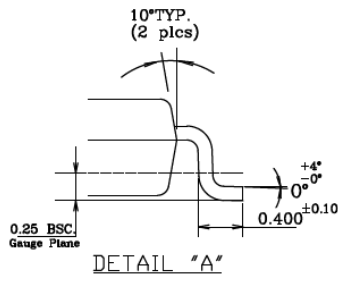
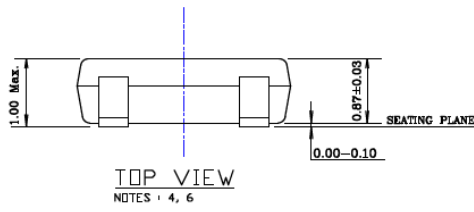
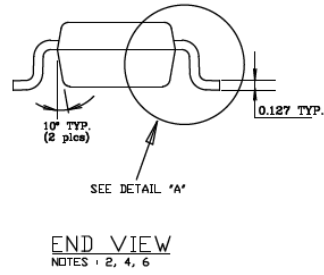
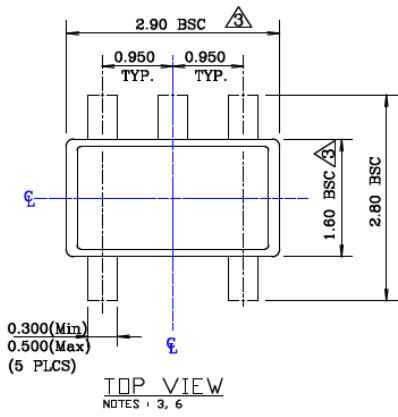
# MIC5207

## 5-Lead TSOT Package Outline and Recommended Land Pattern

**TITLE**

5 LEAD TSOT PACKAGE OUTLINE & RECOMMENDED LAND PATTERN

<b>DRAWING #</b>	TSOT-5LD-PL-1	<b>UNIT</b>	MM
------------------	---------------	-------------	----



- NOTE:**
1. Dimensions and tolerances are as per ANSI Y14.5M, 1994.
  2. Die is facing up for mold. Die is facing down for trim/form, ie. reverse trim/form.
  3. Dimensions are exclusive of mold flash and gate burr.
  4. The footlength measuring is based on the gauge plane method.
  5. All specification comply to Jedec Spec MO193 Issue C.
  6. All dimensions are in millimeters.

Note: For the most current package drawings, please see the Microchip Packaging Specification located at <http://www.microchip.com/packaging>.



## APPENDIX A: REVISION HISTORY

### Revision A (February 2017)

- Converted Micrel document MIC5207 to Microchip data sheet DS20005719A.
- Minor text changes throughout.
- Removed all reference to discontinued leaded parts.
- Added  $\theta_{JC}$  value for SOT-23 package in Temperature Specifications section.

# MIC5207

---

NOTES:

## PRODUCT IDENTIFICATION SYSTEM

To order or obtain information, e.g., on pricing or delivery, contact your local Microchip representative or sales office.

<u>PART NO.</u>	-	<u>XX</u>	<u>X</u>	<u>X</u>	-	<u>XX</u>
Device		Voltage	Temperature	Package		Media Type
<b>Device:</b>		MIC5207:		180 mA Low Noise LDO Regulator		
<b>Voltage:</b>		(blank) = Adjustable				
		1.8 = 1.8V				
		2.5 = 2.5V				
		2.8 = 2.8V				
		2.9 = 2.9V				
		3.0 = 3.0V				
		3.1 = 3.1V				
		3.2 = 3.2V				
		3.3 = 3.3V				
		4.0 = 4.0V				
		5.0 = 5.0V				
<b>Temperature:</b>		Y = -40°C to +125°C				
<b>Package:</b>		D5 = 5-Lead TSOT				
		M5 = 5-Lead SOT-23				
<b>Media Type:</b>		TR = 3,000/Reel				
		TX = 3,000/Reel (Reverse Pin 1 Orientation)				

<b>Examples:</b>	
a) MIC5207-1.8YD5-TR:	180 mA Low-Noise LDO Regulator, 1.8V Voltage, 5-Lead TSOT, -40°C to +125°C Temperature Range, 3,000/Reel
b) MIC5207-2.5YM5-TR:	180 mA Low-Noise LDO Regulator, 2.5V Voltage, 5-Lead SOT-23, -40°C to +125°C Temperature Range, 3,000/Reel
c) MIC5207-2.5YM5-TX:	180 mA Low-Noise LDO Regulator, 2.5V Voltage, 5-Lead SOT-23, -40°C to +125°C Temperature Range, 3,000/Reel (Reverse Pin 1)
d) MIC5207YM5-TR:	180 mA Low-Noise LDO Regulator, Adj. Voltage, 5-Lead SOT-23, -40°C to +125°C Temperature Range, 3,000/Reel
e) MIC5207-2.9YM5-TR:	180 mA Low-Noise LDO Regulator, 2.9V Voltage, 5-Lead SOT-23, -40°C to +125°C Temperature Range, 3,000/Reel
f) MIC5207-3.1YM5-TR:	180 mA Low-Noise LDO Regulator, 3.1V Voltage, 5-Lead SOT-23, -40°C to +125°C Temperature Range, 3,000/Reel
g) MIC5207-5.0YM5-TR:	180 mA Low-Noise LDO Regulator, 5.0V Voltage, 5-Lead SOT-23, -40°C to +125°C Temperature Range, 3,000/Reel
h) MIC5207-3.3YM5-TX:	180 mA Low-Noise LDO Regulator, 3.3V Voltage, 5-Lead SOT-23, -40°C to +125°C Temperature Range, 3,000/Reel (Reverse Pin 1)
<b>Note 1:</b>	Tape and Reel identifier only appears in the catalog part number description. This identifier is used for ordering purposes and is not printed on the device package. Check with your Microchip Sales Office for package availability with the Tape and Reel option.

# MIC5207

---

NOTES:

---

---

**Note the following details of the code protection feature on Microchip devices:**

- Microchip products meet the specification contained in their particular Microchip Data Sheet.
- Microchip believes that its family of products is one of the most secure families of its kind on the market today, when used in the intended manner and under normal conditions.
- There are dishonest and possibly illegal methods used to breach the code protection feature. All of these methods, to our knowledge, require using the Microchip products in a manner outside the operating specifications contained in Microchip's Data Sheets. Most likely, the person doing so is engaged in theft of intellectual property.
- Microchip is willing to work with the customer who is concerned about the integrity of their code.
- Neither Microchip nor any other semiconductor manufacturer can guarantee the security of their code. Code protection does not mean that we are guaranteeing the product as “unbreakable.”

Code protection is constantly evolving. We at Microchip are committed to continuously improving the code protection features of our products. Attempts to break Microchip's code protection feature may be a violation of the Digital Millennium Copyright Act. If such acts allow unauthorized access to your software or other copyrighted work, you may have a right to sue for relief under that Act.

---

Information contained in this publication regarding device applications and the like is provided only for your convenience and may be superseded by updates. It is your responsibility to ensure that your application meets with your specifications. MICROCHIP MAKES NO REPRESENTATIONS OR WARRANTIES OF ANY KIND WHETHER EXPRESS OR IMPLIED, WRITTEN OR ORAL, STATUTORY OR OTHERWISE, RELATED TO THE INFORMATION, INCLUDING BUT NOT LIMITED TO ITS CONDITION, QUALITY, PERFORMANCE, MERCHANTABILITY OR FITNESS FOR PURPOSE. Microchip disclaims all liability arising from this information and its use. Use of Microchip devices in life support and/or safety applications is entirely at the buyer's risk, and the buyer agrees to defend, indemnify and hold harmless Microchip from any and all damages, claims, suits, or expenses resulting from such use. No licenses are conveyed, implicitly or otherwise, under any Microchip intellectual property rights unless otherwise stated.

*Microchip received ISO/TS-16949:2009 certification for its worldwide headquarters, design and wafer fabrication facilities in Chandler and Tempe, Arizona; Gresham, Oregon and design centers in California and India. The Company's quality system processes and procedures are for its PIC® MCUs and dsPIC® DSCs, KEELoC® code hopping devices, Serial EEPROMs, microperipherals, nonvolatile memory and analog products. In addition, Microchip's quality system for the design and manufacture of development systems is ISO 9001:2000 certified.*

**QUALITY MANAGEMENT SYSTEM  
CERTIFIED BY DNV  
= ISO/TS 16949 =**

### Trademarks

The Microchip name and logo, the Microchip logo, AnyRate, AVR, AVR logo, AVR Freaks, BeaconThings, BitCloud, CryptoMemory, CryptoRF, dsPIC, FlashFlex, flexPWR, Heldo, JukeBlox, KEELoC, KEELoC logo, Klear, LANCheck, LINK MD, maXStylus, maXTouch, MediaLB, megaAVR, MOST, MOST logo, MPLAB, OptoLyzer, PIC, picoPower, PICSTART, PIC32 logo, Prochip Designer, QTouch, RightTouch, SAM-BA, SpyNIC, SST, SST Logo, SuperFlash, tinyAVR, UNI/O, and XMEGA are registered trademarks of Microchip Technology Incorporated in the U.S.A. and other countries.

ClockWorks, The Embedded Control Solutions Company, EtherSynch, Hyper Speed Control, HyperLight Load, IntelliMOS, mTouch, Precision Edge, and Quiet-Wire are registered trademarks of Microchip Technology Incorporated in the U.S.A.

Adjacent Key Suppression, AKS, Analog-for-the-Digital Age, Any Capacitor, AnyIn, AnyOut, BodyCom, chipKIT, chipKIT logo, CodeGuard, CryptoAuthentication, CryptoCompanion, CryptoController, dsPICDEM, dsPICDEM.net, Dynamic Average Matching, DAM, ECAN, EtherGREEN, In-Circuit Serial Programming, ICSP, Inter-Chip Connectivity, JitterBlocker, KlearNet, KlearNet logo, Mindi, MiWi, motorBench, MPASM, MPF, MPLAB Certified logo, MPLIB, MPLINK, MultiTRAK, NetDetach, Omniscient Code Generation, PICDEM, PICDEM.net, PICKit, PICtail, PureSilicon, QMatrix, RightTouch logo, REAL ICE, Ripple Blocker, SAM-ICE, Serial Quad I/O, SMART-I.S., SQI, SuperSwitcher, SuperSwitcher II, Total Endurance, TSHARC, USBCheck, VariSense, ViewSpan, WiperLock, Wireless DNA, and ZENA are trademarks of Microchip Technology Incorporated in the U.S.A. and other countries.

SQTP is a service mark of Microchip Technology Incorporated in the U.S.A.

Silicon Storage Technology is a registered trademark of Microchip Technology Inc. in other countries.

GestIC is a registered trademark of Microchip Technology Germany II GmbH & Co. KG, a subsidiary of Microchip Technology Inc., in other countries.

All other trademarks mentioned herein are property of their respective companies.

© 2017, Microchip Technology Incorporated, All Rights Reserved.  
ISBN: 978-1-5224-1408-7



# MICROCHIP

## Worldwide Sales and Service

### AMERICAS

**Corporate Office**  
2355 West Chandler Blvd.  
Chandler, AZ 85224-6199  
Tel: 480-792-7200  
Fax: 480-792-7277  
Technical Support:  
<http://www.microchip.com/support>  
Web Address:  
[www.microchip.com](http://www.microchip.com)

**Atlanta**  
Duluth, GA  
Tel: 678-957-9614  
Fax: 678-957-1455

**Austin, TX**  
Tel: 512-257-3370

**Boston**  
Westborough, MA  
Tel: 774-760-0087  
Fax: 774-760-0088

**Chicago**  
Itasca, IL  
Tel: 630-285-0071  
Fax: 630-285-0075

**Dallas**  
Addison, TX  
Tel: 972-818-7423  
Fax: 972-818-2924

**Detroit**  
Novi, MI  
Tel: 248-848-4000

**Houston, TX**  
Tel: 281-894-5983

**Indianapolis**  
Noblesville, IN  
Tel: 317-773-8323  
Fax: 317-773-5453  
Tel: 317-536-2380

**Los Angeles**  
Mission Viejo, CA  
Tel: 949-462-9523  
Fax: 949-462-9608  
Tel: 951-273-7800

**Raleigh, NC**  
Tel: 919-844-7510

**New York, NY**  
Tel: 631-435-6000

**San Jose, CA**  
Tel: 408-735-9110  
Tel: 408-436-4270

**Canada - Toronto**  
Tel: 905-695-1980  
Fax: 905-695-2078

### ASIA/PACIFIC

**Asia Pacific Office**  
Suites 3707-14, 37th Floor  
Tower 6, The Gateway  
Harbour City, Kowloon

**Hong Kong**  
Tel: 852-2943-5100  
Fax: 852-2401-3431

**Australia - Sydney**  
Tel: 61-2-9868-6733  
Fax: 61-2-9868-6755

**China - Beijing**  
Tel: 86-10-8569-7000  
Fax: 86-10-8528-2104

**China - Chengdu**  
Tel: 86-28-8665-5511  
Fax: 86-28-8665-7889

**China - Chongqing**  
Tel: 86-23-8980-9588  
Fax: 86-23-8980-9500

**China - Dongguan**  
Tel: 86-769-8702-9880

**China - Guangzhou**  
Tel: 86-20-8755-8029

**China - Hangzhou**  
Tel: 86-571-8792-8115  
Fax: 86-571-8792-8116

**China - Hong Kong SAR**  
Tel: 852-2943-5100  
Fax: 852-2401-3431

**China - Nanjing**  
Tel: 86-25-8473-2460  
Fax: 86-25-8473-2470

**China - Qingdao**  
Tel: 86-532-8502-7355  
Fax: 86-532-8502-7205

**China - Shanghai**  
Tel: 86-21-3326-8000  
Fax: 86-21-3326-8021

**China - Shenyang**  
Tel: 86-24-2334-2829  
Fax: 86-24-2334-2393

**China - Shenzhen**  
Tel: 86-755-8864-2200  
Fax: 86-755-8203-1760

**China - Wuhan**  
Tel: 86-27-5980-5300  
Fax: 86-27-5980-5118

**China - Xian**  
Tel: 86-29-8833-7252  
Fax: 86-29-8833-7256

### ASIA/PACIFIC

**China - Xiamen**  
Tel: 86-592-2388138  
Fax: 86-592-2388130

**China - Zhuhai**  
Tel: 86-756-3210040  
Fax: 86-756-3210049

**India - Bangalore**  
Tel: 91-80-3090-4444  
Fax: 91-80-3090-4123

**India - New Delhi**  
Tel: 91-11-4160-8631  
Fax: 91-11-4160-8632

**India - Pune**  
Tel: 91-20-3019-1500

**Japan - Osaka**  
Tel: 81-6-6152-7160  
Fax: 81-6-6152-9310

**Japan - Tokyo**  
Tel: 81-3-6880-3770  
Fax: 81-3-6880-3771

**Korea - Daegu**  
Tel: 82-53-744-4301  
Fax: 82-53-744-4302

**Korea - Seoul**  
Tel: 82-2-554-7200  
Fax: 82-2-558-5932 or  
82-2-558-5934

**Malaysia - Kuala Lumpur**  
Tel: 60-3-6201-9857  
Fax: 60-3-6201-9859

**Malaysia - Penang**  
Tel: 60-4-227-8870  
Fax: 60-4-227-4068

**Philippines - Manila**  
Tel: 63-2-634-9065  
Fax: 63-2-634-9069

**Singapore**  
Tel: 65-6334-8870  
Fax: 65-6334-8850

**Taiwan - Hsin Chu**  
Tel: 886-3-5778-366  
Fax: 886-3-5770-955

**Taiwan - Kaohsiung**  
Tel: 886-7-213-7830

**Taiwan - Taipei**  
Tel: 886-2-2508-8600  
Fax: 886-2-2508-0102

**Thailand - Bangkok**  
Tel: 66-2-694-1351  
Fax: 66-2-694-1350

### EUROPE

**Austria - Wels**  
Tel: 43-7242-2244-39  
Fax: 43-7242-2244-393

**Denmark - Copenhagen**  
Tel: 45-4450-2828  
Fax: 45-4485-2829

**Finland - Espoo**  
Tel: 358-9-4520-820

**France - Paris**  
Tel: 33-1-69-53-63-20  
Fax: 33-1-69-30-90-79

**France - Saint Cloud**  
Tel: 33-1-30-60-70-00

**Germany - Garching**  
Tel: 49-8931-9700

**Germany - Haan**  
Tel: 49-2129-3766400

**Germany - Heilbronn**  
Tel: 49-7131-67-3636

**Germany - Karlsruhe**  
Tel: 49-721-625370

**Germany - Munich**  
Tel: 49-89-627-144-0  
Fax: 49-89-627-144-44

**Germany - Rosenheim**  
Tel: 49-8031-354-560

**Israel - Ra'anana**  
Tel: 972-9-744-7705

**Italy - Milan**  
Tel: 39-0331-742611  
Fax: 39-0331-466781

**Italy - Padova**  
Tel: 39-049-7625286

**Netherlands - Drunen**  
Tel: 31-416-690399  
Fax: 31-416-690340

**Norway - Trondheim**  
Tel: 47-7289-7561

**Poland - Warsaw**  
Tel: 48-22-3325737

**Romania - Bucharest**  
Tel: 40-21-407-87-50

**Spain - Madrid**  
Tel: 34-91-708-08-90  
Fax: 34-91-708-08-91

**Sweden - Gothenberg**  
Tel: 46-31-704-60-40

**Sweden - Stockholm**  
Tel: 46-8-5090-4654

**UK - Wokingham**  
Tel: 44-118-921-5800  
Fax: 44-118-921-5820