

Features

- Low I_H :
 - 13 mA max
- High surge current:
 - $I_{TSM} = 120$ A
- I_{GT} specified in four quadrants
- Insulating voltage:
 - 2500 V_(RMS) (UL Recognized: E81734)

Description

The BTA10-600GP uses high performance, glass passivated chips.

The insulated TO-220AB package, the high surge current and low holding current make this product well adapted to CFL and LED dimmer applications.

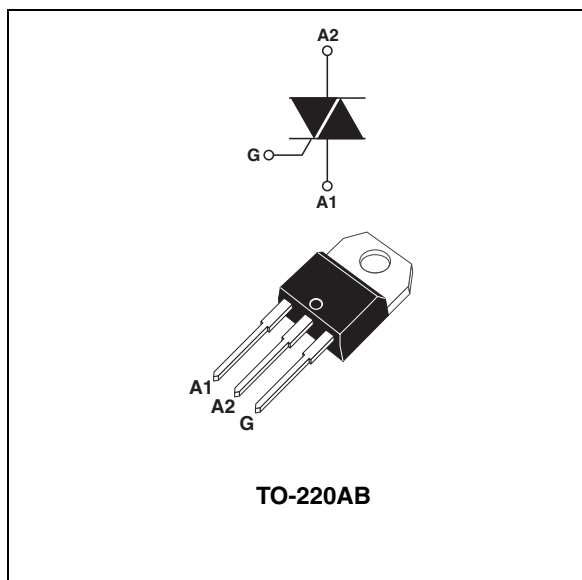

1 Characteristics

Table 1. Absolute ratings (limiting values)

Symbol	Parameter		Value	Unit
V_{DRM} V_{RRM}	Repetitive peak off-state voltage $T_j = 125^\circ\text{C}$		600	V
$I_{T(RMS)}$	RMS on-state current (360° conduction angle)	$T_c = 90^\circ\text{C}$	10	A
I_{TSM}	Non repetitive surge peak on-state current (T_j initial = 25° C)	$t_p = 8.3\text{ ms}$	126	A
		$t_p = 10\text{ ms}$	120	
I^2t	I^2t Value for fusing	$t_p = 10\text{ ms}$	72	A ² s
di/dt	Critical rate of rise of on-state current $I_G = 500\text{ mA}$ $di_G/dt = 1\text{ A}/\mu\text{s}$	Repetitive F = 50 Hz	10	A/ μs
		Non repetitive	50	
T_{stg} T_j	Storage junction temperature range Operating junction temperature range		-40 to +150 -40 to +125	° C

Table 2. Electrical characteristics

Symbol	Test conditions		Quadrant		Value	Unit
$I_{GT}^{(1)}$	$V_D = 12\text{ V (DC)}$ $R_L = 33\ \Omega$	$T_j = 25^\circ\text{C}$	I - II - III	MAX	25	mA
			IV	MAX	100	
V_{GT}	$V_D = 12\text{ V (DC)}$ $R_L = 33\ \Omega$	$T_j = 25^\circ\text{C}$	I - II - III - IV	MAX	1.5	V
V_{GD}	$V_D = V_{DRM}$ $R_L = 3.3\text{ k}\Omega$	$T_j = 110^\circ\text{C}$	I - II - III - IV	MIN	0.2	V
t_{gt}	$V_D = V_{DRM}$ $I_G = 500\text{ mA}$ $di_G/dt = 3\text{ A}/\mu\text{s}$	$T_j = 25^\circ\text{C}$	I - II - III - IV	TYP	2	μs
I_L	$I_G = 1.2 I_{GT}$	$T_j = 25^\circ\text{C}$	I - II - III	TYP	20	mA
			IV		40	
$I_H^{(1)}$	$I_T = 100\text{ mA}$ gate open	$T_j = 25^\circ\text{C}$		MAX	13	mA
$V_{TM}^{(1)}$	$I_{TM} = 14\text{ A}$ $t_p = 380\ \mu\text{s}$	$T_j = 25^\circ\text{C}$		MAX	1.5	V
I_{DRM} I_{RRM}	$V_{DRM} = V_{RRM}$	$T_j = 25^\circ\text{C}$		MAX	0.01	mA
		$T_j = 110^\circ\text{C}$		MAX	0.5	
$dV/dt^{(1)}$	Linear slope up to $V_D = 67\% V_{DRM}$ gate open	$T_j = 110^\circ\text{C}$		MIN	30	V/ μs
				TYP	100	
$(dV/dt)_c^{(1)}$	$(di/dt)_c = 2.2\text{ A/ms}$	$T_j = 110^\circ\text{C}$		MIN	1	V/ μs
				TYP	10	

1. For either polarity of electrode A₂ voltage with reference to electrode A₁.

Table 3. Gate characteristics (maximum values)

Symbol	Parameter	Value	Unit
$P_{G(AV)}$	Average gate power dissipation	1	W
P_{GM}	Peak gate power dissipation	$t_p = 20 \mu s$ 10	W
I_{GM}	Peak gate current	$t_p = 20 \mu s$ 4	A
V_{GM}	Peak positive gate voltage	$t_p = 20 \mu s$ 16	V

Table 4. Thermal resistances

Symbol	Parameter	Value	Unit
$R_{th(j-a)}$	Junction to ambient	60	°C/W
$R_{th(j-c)}$ DC	Junction to case for DC	4	
$R_{th(j-c)}$ AC	Junction to case for 360° conduction angle (F = 50 Hz)	3	

Figure 1. Maximum rms power dissipation versus rms on-state current

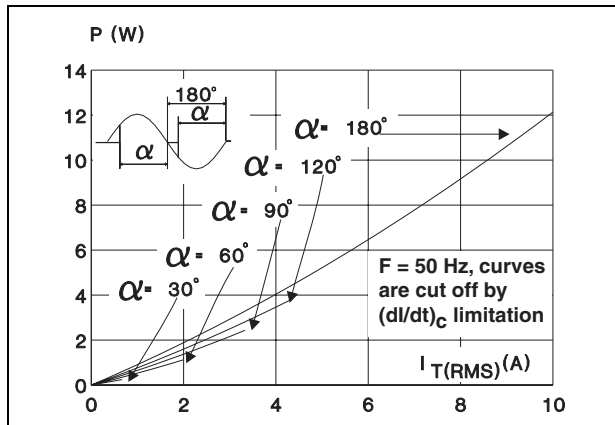

Figure 2. Maximum rms power dissipation and maximum allowable temperatures (T_{amb} and T_{case})

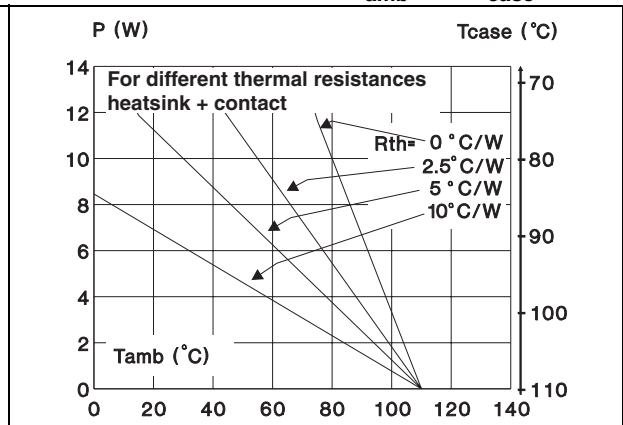

Figure 3. On-state rms current versus case temperature

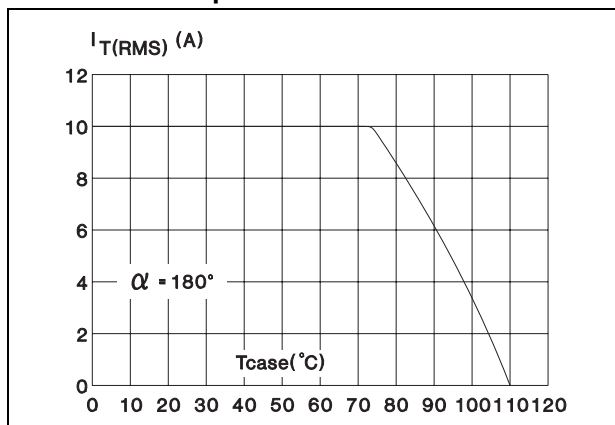

Figure 4. Relative variation of thermal impedance versus pulse duration

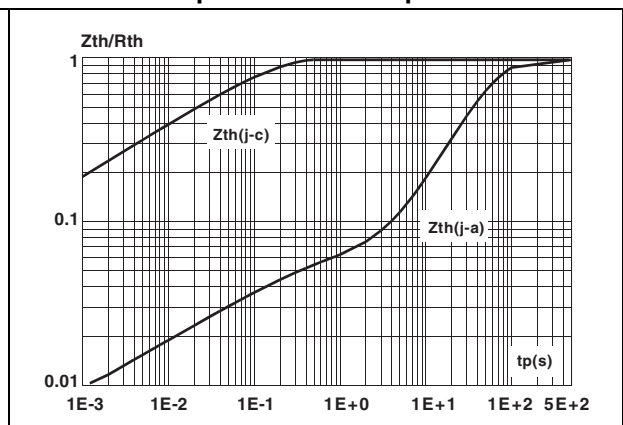

Figure 5. Relative variation of gate trigger current and holding current versus junction temperature

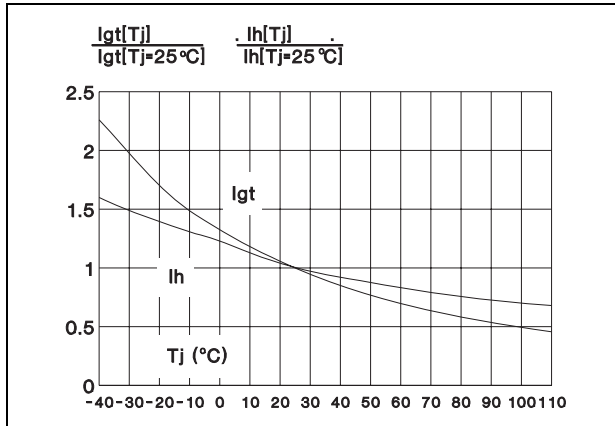

Figure 6. Non repetitive surge peak on-state current versus number of cycles

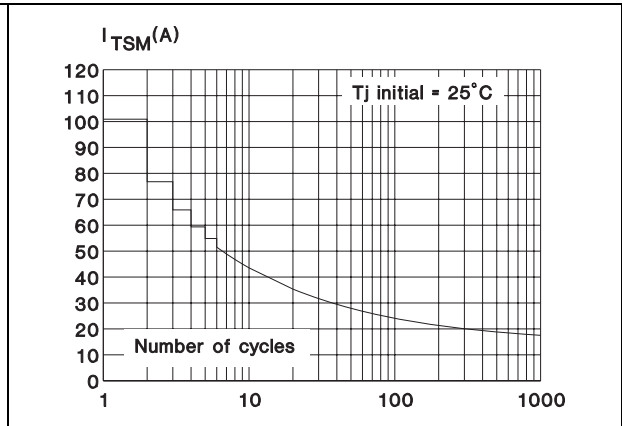

Figure 7. Non repetitive surge peak on-state current and corresponding value of I^2t

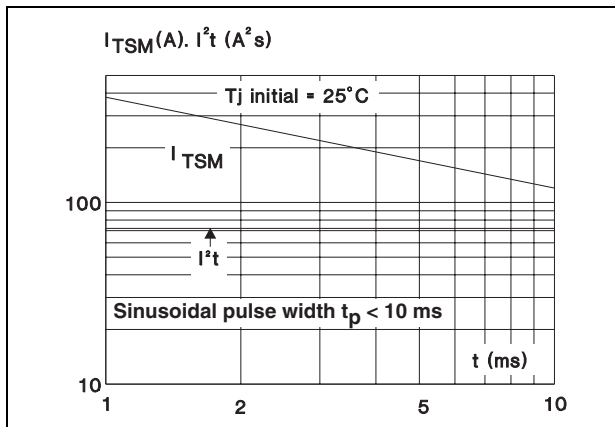
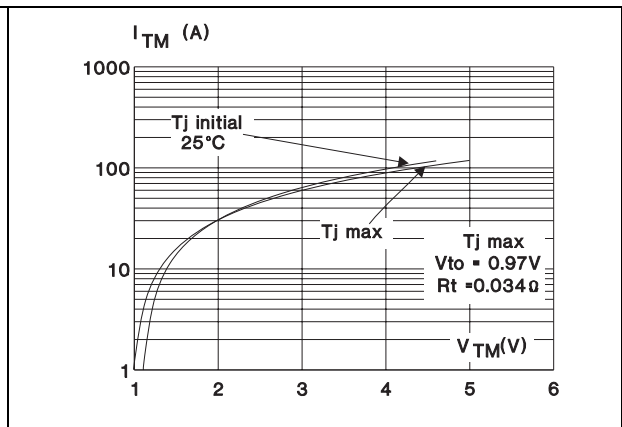

Figure 8. On-state characteristics (maximum values)



2 Package information

- Epoxy meets UL94,V0
- Cooling method: Conduction
- Recommended torque value: 0.4 to 0.6 N·m

In order to meet environmental requirements, ST offers these devices in different grades of ECOPACK® packages, depending on their level of environmental compliance. ECOPACK® specifications, grade definitions and product status are available at: www.st.com. ECOPACK® is an ST trademark.

Table 5. TO-220AB dimensions

Ref.	Dimensions					
	Millimeters			Inches		
	Min.	Typ.	Max.	Min.	Typ.	Max.
A	15.20		15.90	0.598		0.625
a1		3.75			0.147	
a2	13.00		14.00	0.511		0.551
B	10.00		10.40	0.393		0.409
b1	0.61		0.88	0.024		0.034
b2	1.23		1.32	0.048		0.051
C	4.40		4.60	0.173		0.181
c1	0.49		0.70	0.019		0.027
c2	2.40		2.72	0.094		0.107
e	2.40		2.70	0.094		0.106
F	6.20		6.60	0.244		0.259
ØI	3.75		3.85	0.147		0.151
I4	15.80	16.40	16.80	0.622	0.646	0.661
L	2.65		2.95	0.104		0.116
I2	1.14		1.70	0.044		0.066
I3	1.14		1.70	0.044		0.066
M		2.60			0.102	

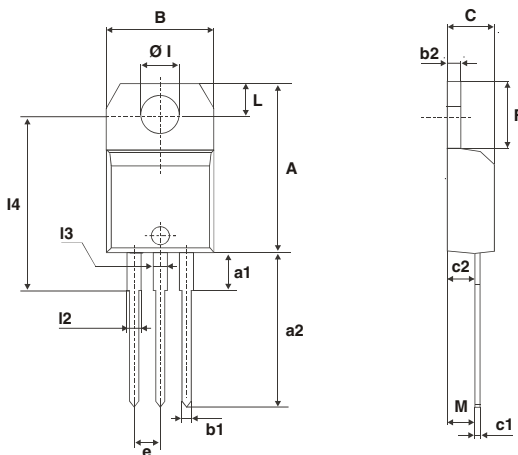

3 Ordering information

Table 6. Ordering information

Order code	Marking	Package	Weight	Base qty	Delivery mode
BTA10-600GPRG	BTA10 600GP	TO-220AB	2.3 g	50	Tube

4 Revision history

Table 7. Document revision history

Date	Revision	Changes
13-Sep-2011	1	Initial release

Please Read Carefully:

Information in this document is provided solely in connection with ST products. STMicroelectronics NV and its subsidiaries ("ST") reserve the right to make changes, corrections, modifications or improvements, to this document, and the products and services described herein at any time, without notice.

All ST products are sold pursuant to ST's terms and conditions of sale.

Purchasers are solely responsible for the choice, selection and use of the ST products and services described herein, and ST assumes no liability whatsoever relating to the choice, selection or use of the ST products and services described herein.

No license, express or implied, by estoppel or otherwise, to any intellectual property rights is granted under this document. If any part of this document refers to any third party products or services it shall not be deemed a license grant by ST for the use of such third party products or services, or any intellectual property contained therein or considered as a warranty covering the use in any manner whatsoever of such third party products or services or any intellectual property contained therein.

UNLESS OTHERWISE SET FORTH IN ST'S TERMS AND CONDITIONS OF SALE ST DISCLAIMS ANY EXPRESS OR IMPLIED WARRANTY WITH RESPECT TO THE USE AND/OR SALE OF ST PRODUCTS INCLUDING WITHOUT LIMITATION IMPLIED WARRANTIES OF MERCHANTABILITY, FITNESS FOR A PARTICULAR PURPOSE (AND THEIR EQUIVALENTS UNDER THE LAWS OF ANY JURISDICTION), OR INFRINGEMENT OF ANY PATENT, COPYRIGHT OR OTHER INTELLECTUAL PROPERTY RIGHT.

UNLESS EXPRESSLY APPROVED IN WRITING BY TWO AUTHORIZED ST REPRESENTATIVES, ST PRODUCTS ARE NOT RECOMMENDED, AUTHORIZED OR WARRANTED FOR USE IN MILITARY, AIR CRAFT, SPACE, LIFE SAVING, OR LIFE SUSTAINING APPLICATIONS, NOR IN PRODUCTS OR SYSTEMS WHERE FAILURE OR MALFUNCTION MAY RESULT IN PERSONAL INJURY, DEATH, OR SEVERE PROPERTY OR ENVIRONMENTAL DAMAGE. ST PRODUCTS WHICH ARE NOT SPECIFIED AS "AUTOMOTIVE GRADE" MAY ONLY BE USED IN AUTOMOTIVE APPLICATIONS AT USER'S OWN RISK.

Resale of ST products with provisions different from the statements and/or technical features set forth in this document shall immediately void any warranty granted by ST for the ST product or service described herein and shall not create or extend in any manner whatsoever, any liability of ST.

ST and the ST logo are trademarks or registered trademarks of ST in various countries.

Information in this document supersedes and replaces all information previously supplied.

The ST logo is a registered trademark of STMicroelectronics. All other names are the property of their respective owners.

© 2011 STMicroelectronics - All rights reserved

STMicroelectronics group of companies

Australia - Belgium - Brazil - Canada - China - Czech Republic - Finland - France - Germany - Hong Kong - India - Israel - Italy - Japan - Malaysia - Malta - Morocco - Philippines - Singapore - Spain - Sweden - Switzerland - United Kingdom - United States of America

www.st.com