

WL2805

Low power consumption, CMOS LDO

[Http://www.sh-willsemi.com](http://www.sh-willsemi.com)

Descriptions

The WL2805 series are low dropout linear regulators and optimized to provide a high performance solution for battery power system to deliver low quiescent current. The devices offer a new level of cost effective performance in cellular phones, laptop and notebook computers, and other portable devices.

The WL2805 series are designed to make use of low cost ceramic capacitors which ensure the stability of the output current, and enhance the efficiency in order to prolong the battery life of those portable devices.

The WL2805 regulators are available in SOT-23-3L packages. Standard products are Pb-free and Halogen free products.



SOT-23-3L

SOT-23-5L

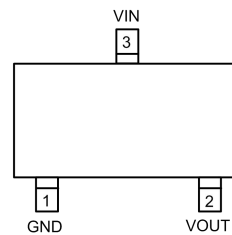

WL2805N**

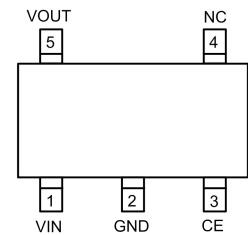

WL2805E**

Pin Configuration (Top View)

Features

- Quiescent current : 3μA Typ.
- Input voltage : 2.3V ~ 5.5V
- Output voltage : 1.2V ~ 3.3V
- Output current : 250mA @ $V_{OUT} > 2V$
- Output current : 100mA @ $V_{OUT} \leq 2V$
- Dropout voltage : 100mV @ 100mA
- Recommend capacitor : 1uF
- Operating Temperature : -40 ~ +85 °C
- Output short protection

Applications

- MP3/MP4 Players
- Cell phones
- Bluetooth earphone
- Wireless mouse
- Others electronics devices

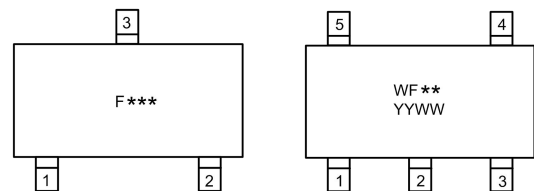

For detail marking information please see page 9.

Marking

Order Information

For detail order information please see page 9.

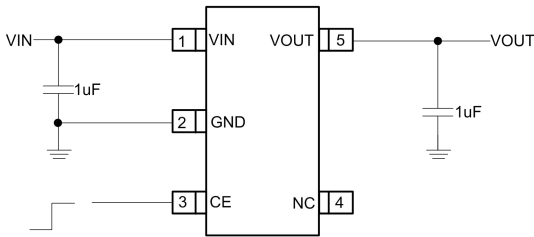
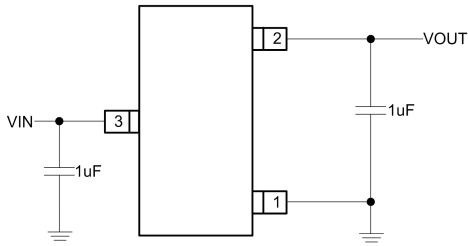
Typical Applications

Pin Descriptions

PIN	Symbol	Description
1	GND	Ground
2	VOUT	Output
3	VIN	Input

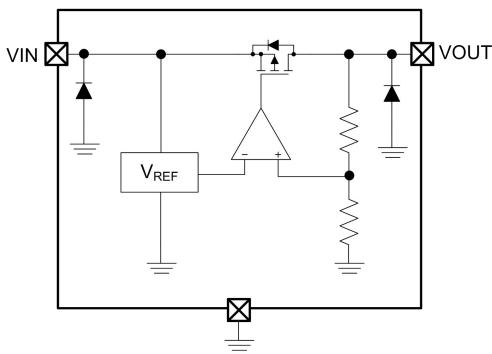
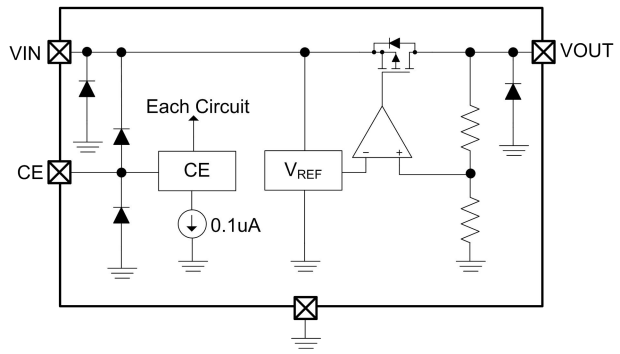
PIN	Symbol	Description
1	VIN	Input
2	GND	Ground
3	CE	Chip Enable, Active High
4	NC	Not connected
5	VOUT	Output

Block Diagram

WL2805N**

WL2805E**

Absolute Maximum Ratings

Parameter	Value	Unit
Power Dissipation	300	mW
V _{IN} Range	-0.3 ~ 6.0	V
V _{EN} Range	-0.3 ~ V _{IN}	V
V _{OUT} Range	-0.3 ~ V _{IN}	V
Lead Temperature	260	°C
Storage Temperature	-65 ~ 150	°C
Operating Junction Temperature	150	°C

Operating Range

Parameter	Value	Unit
Thermal Resistance, R _{θJA}	250	°C/W
Input Voltage	2.3 ~ 5.5	V
Operating Temperature Range	-40 ~ 85	°C

Electronics Characteristics (V_{IN} = V_{OUT} + 1V, C_{IN} = C_{OUT} = 1μF, T_A = 25°C, unless otherwise noted)

Parameter	Symbol	Condition	Min.	Typ.	Max.	Unit
Output Voltage	V _{OUT}	V _{IN} = V _{OUT} + 1V, I _{OUT} = 1mA	1.170	1.200	1.230	V
			1.270	1.300	1.330	
			1.470	1.500	1.530	
			1.764	1.800	1.836	
			2.450	2.500	2.550	
			2.744	2.800	2.856	
			2.940	3.000	3.060	
			3.234	3.300	3.366	
Output Current	I _{OUT}	V _{OUT} > 2V			250	mA
		V _{OUT} ≤ 2V			100	
Output short current limiter	I _{LIM}	V _{OUT} = GND		150		mA
Dropout Voltage	V _{DROP}	I _{OUT} = 30mA, V _{OUT} = 3.0V		30	100	mV
		I _{OUT} = 100mA, V _{OUT} = 3.0V		100	200	
Line Regulation	ΔV _{LINE}	V _{IN} = V _{OUT} + 1V ~ 6V, I _{OUT} = 40mA			0.1	%/V
Load Regulation	ΔV _{LOAD}	I _{OUT} = 1 ~ 100mA		25		mV
Quiescent Current	I _Q	V _{IN} = V _{OUT} + 1V, I _{OUT} = 0A		3	5	μA
Shut-down Current	I _{SHDN}	V _{EN} = 0V			1.0	μA
Power Supply Ripple Rejection	PSRR	V _{p-p} = 1V, F = 100Hz, I _{OUT} = 10mA		-50		dB
		V _{p-p} = 1V, F = 1KHz, I _{OUT} = 10mA		-30		dB

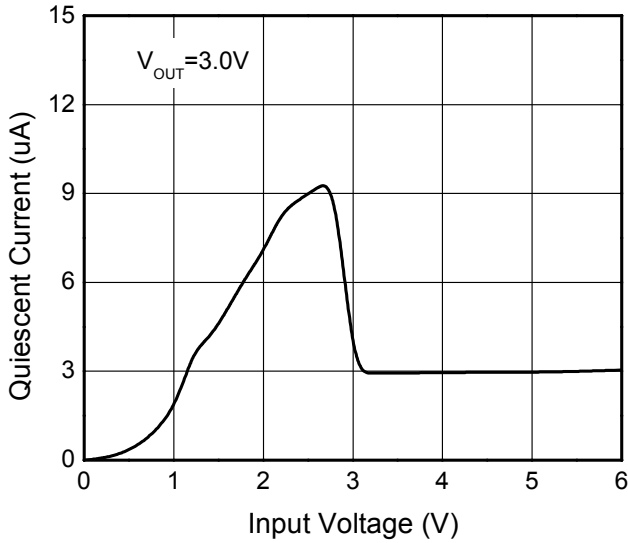
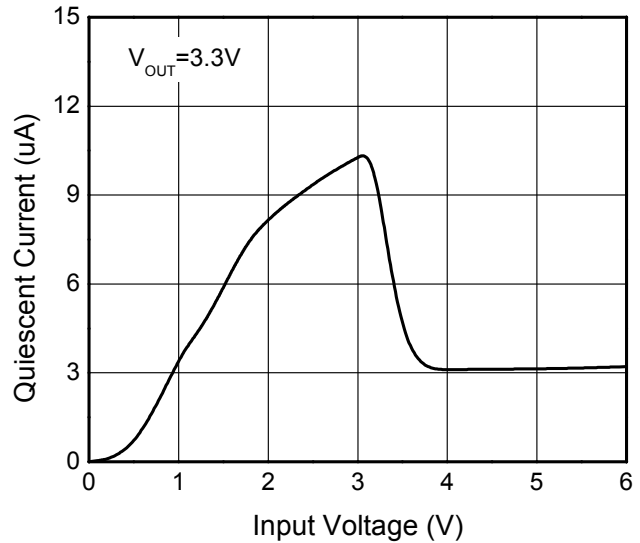
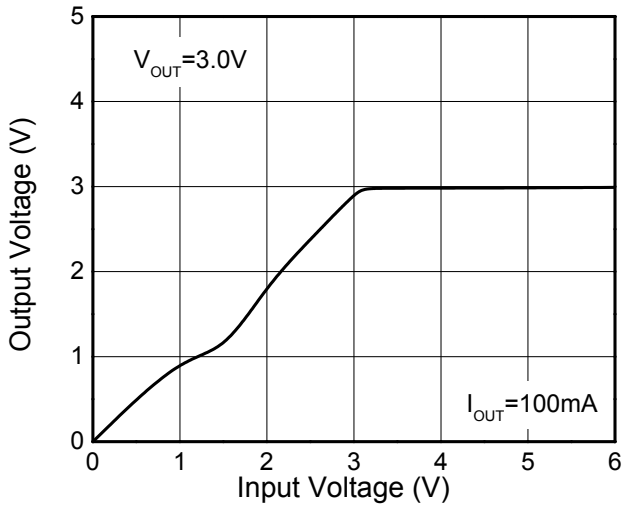
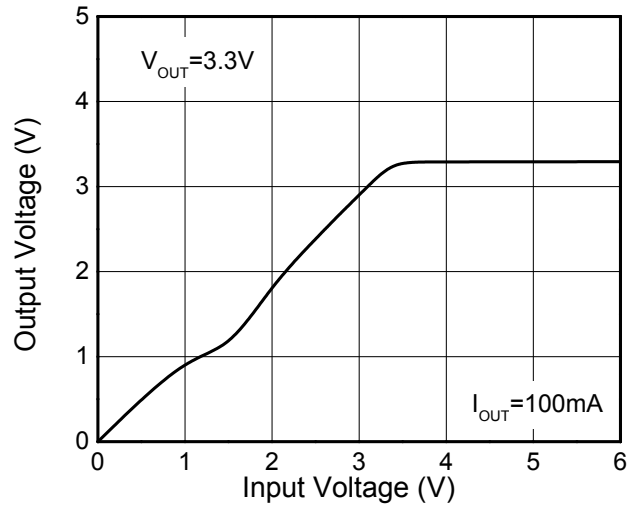
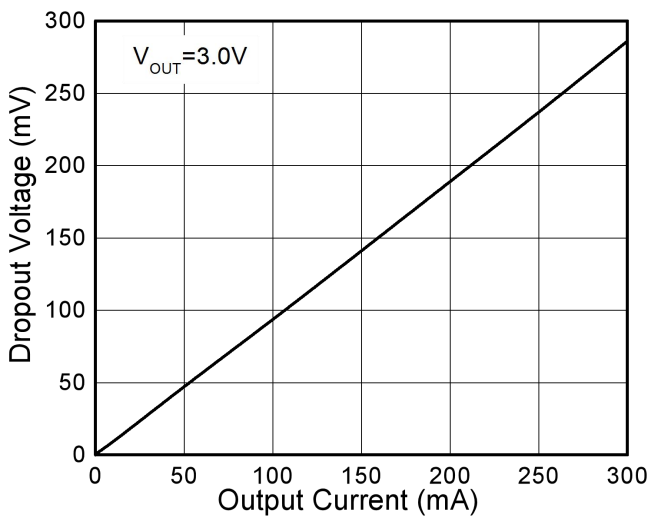
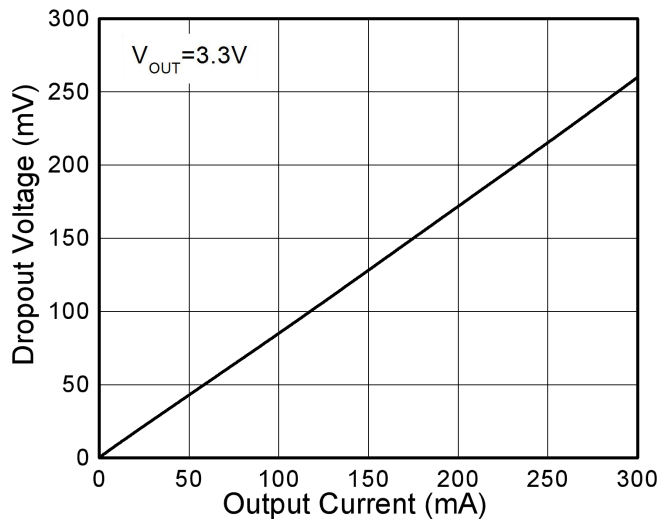
Typical Characteristics ($T_A=25^\circ\text{C}$, unless otherwise noted)

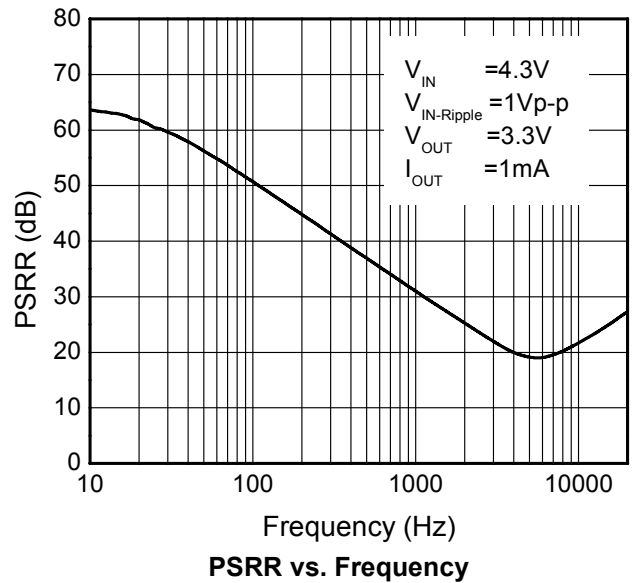
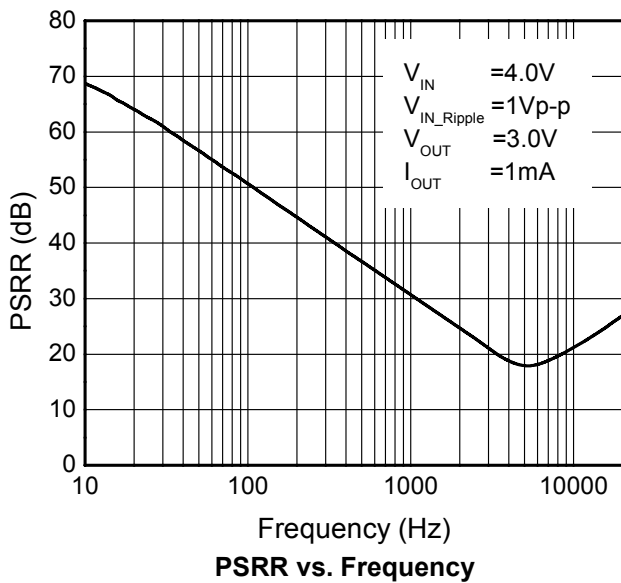
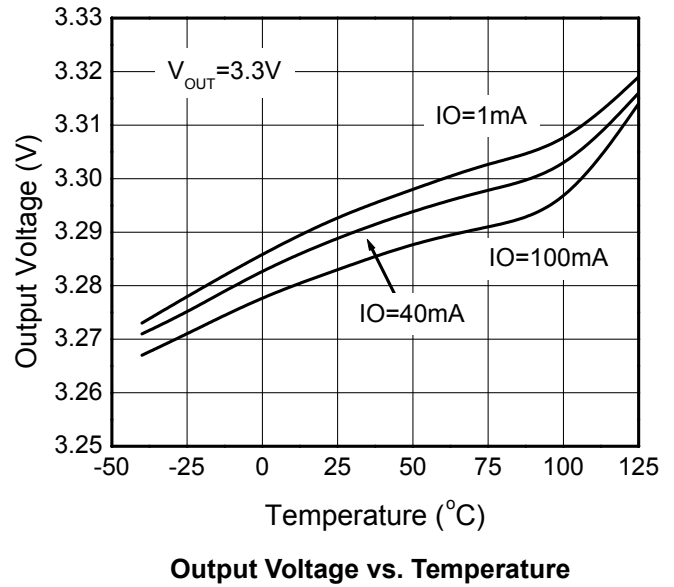
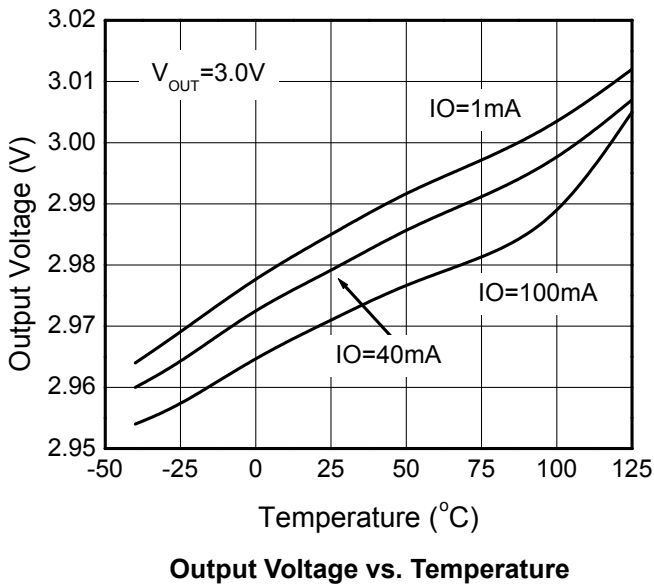
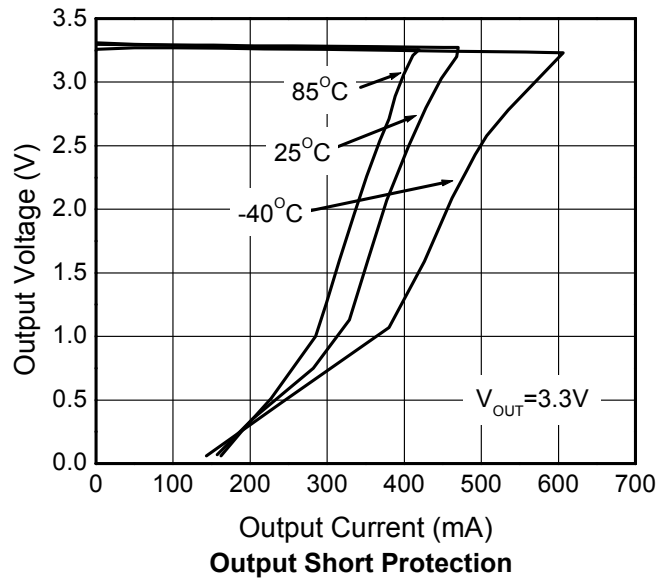
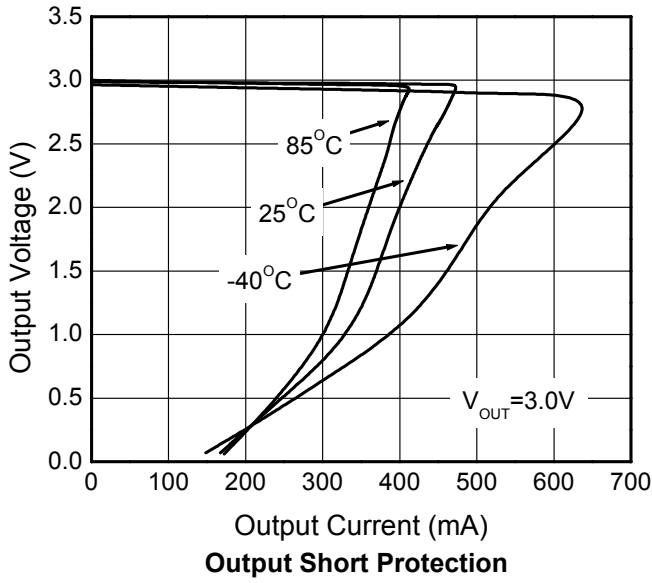
Quiescent Current vs. Input Voltage

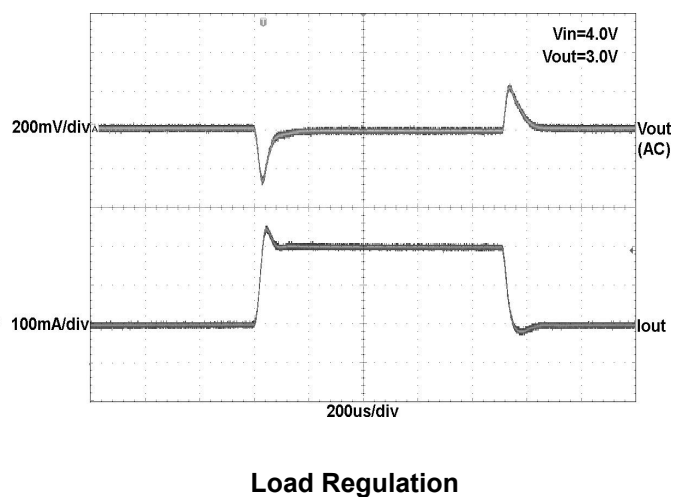
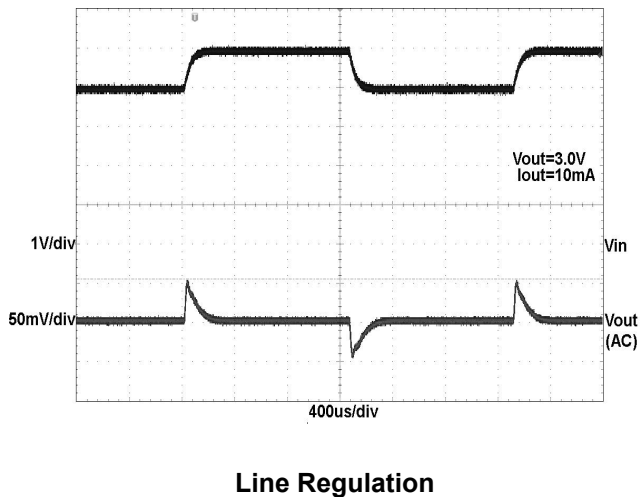
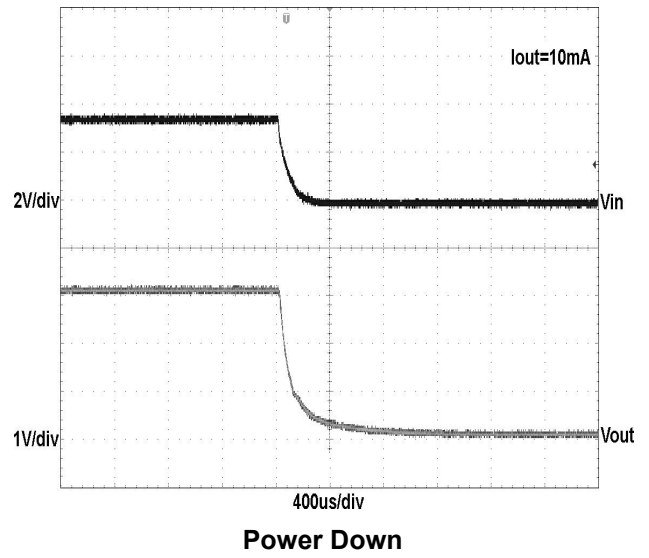
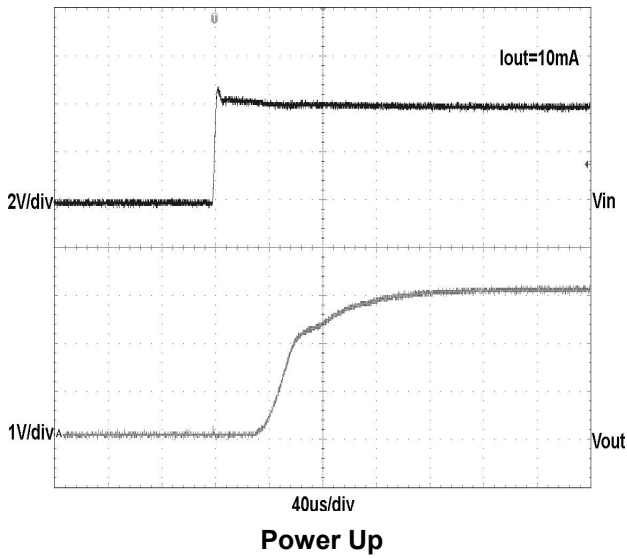
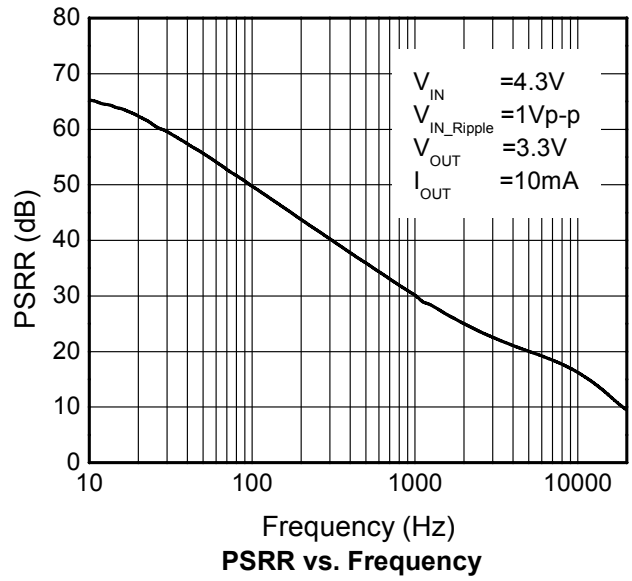
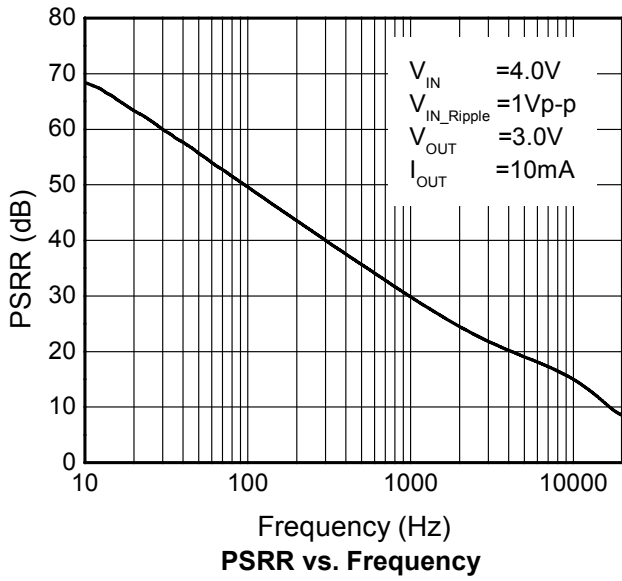
Quiescent Current vs. Input Voltage

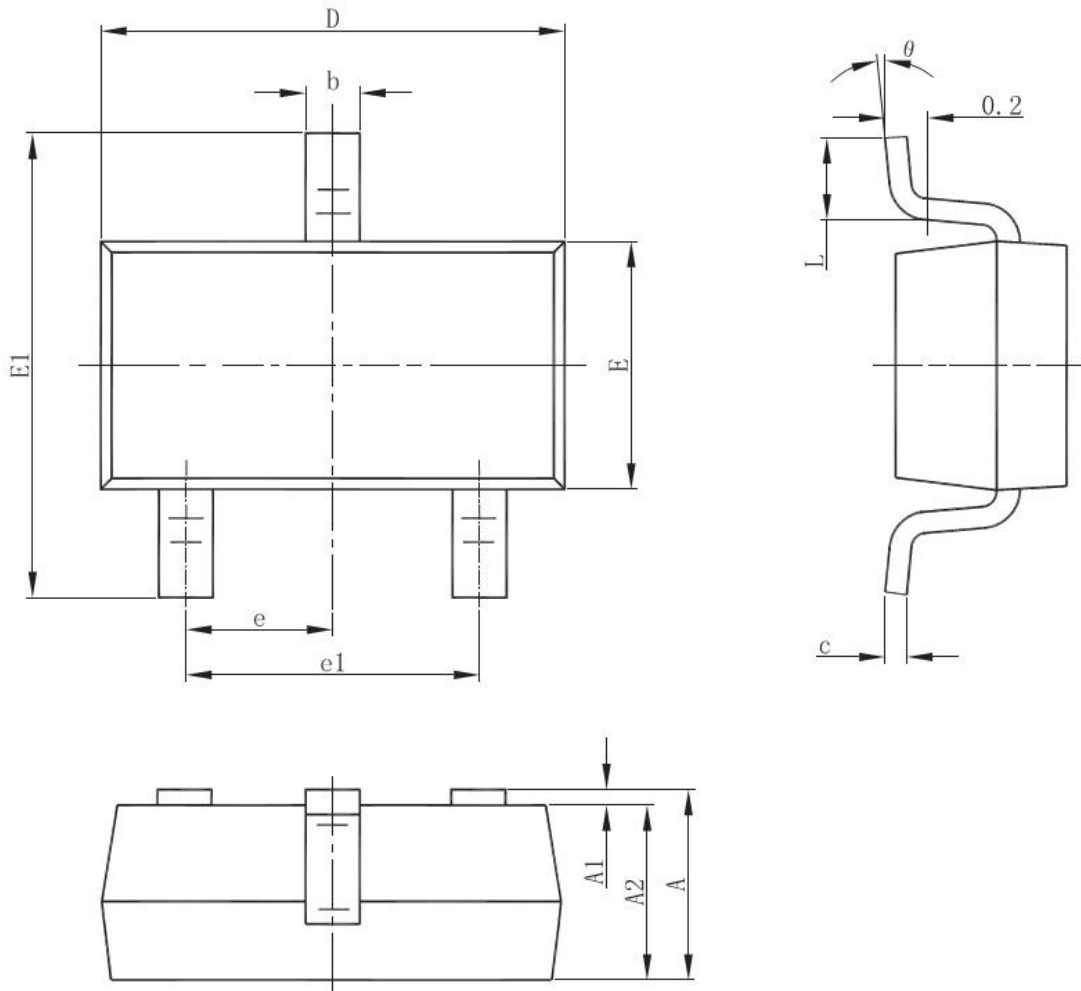
Output Voltage vs. Input Voltage

Output Voltage vs. Input Voltage

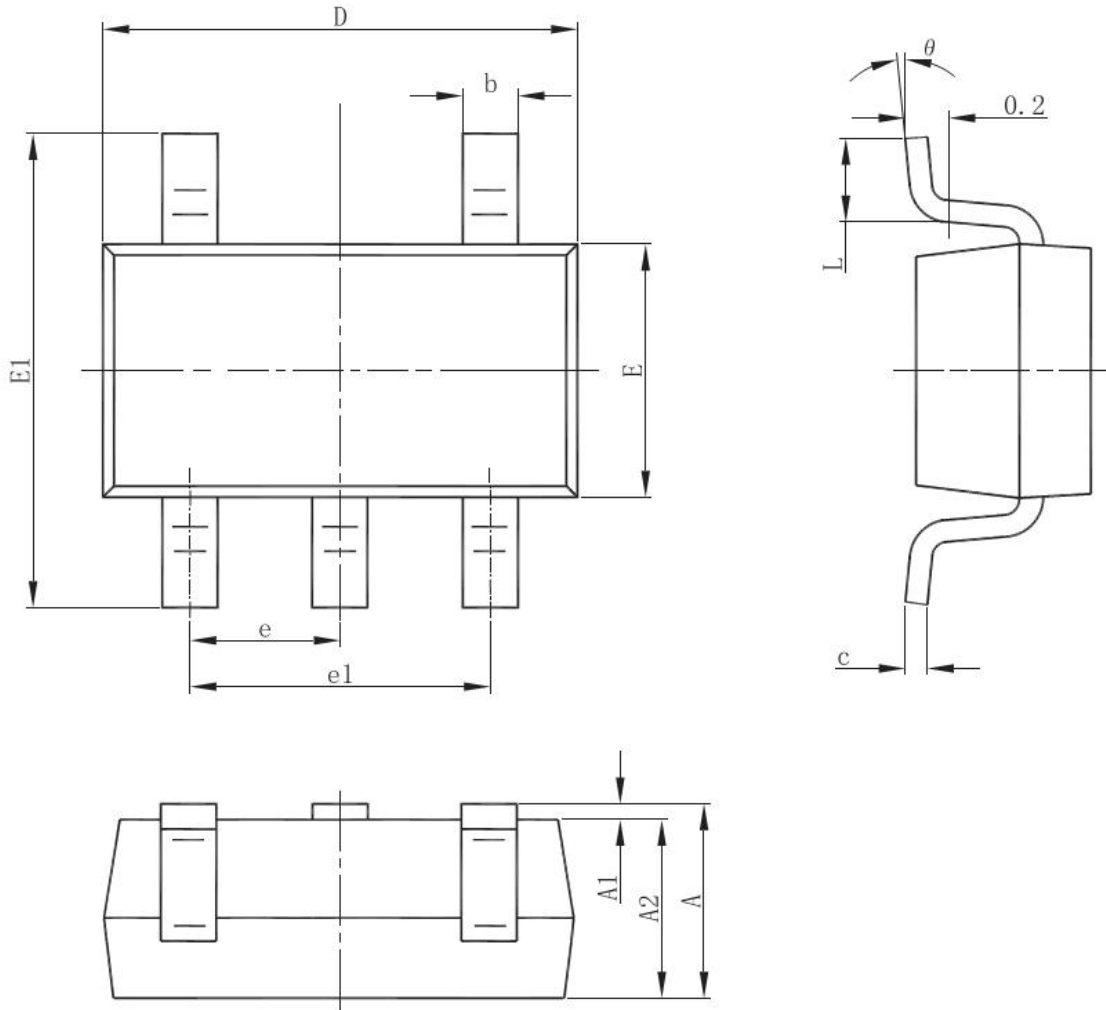
Dropout Voltage vs. Output Current

Dropout Voltage vs. Output Current





Package outline dimensions
SOT-23-3L

Symbol	Dimensions In Millimeters	
	Min.	Max.
A	1.050	1.250
A1	0.000	0.100
A2	1.050	1.150
b	0.300	0.500
c	0.100	0.200
D	2.820	3.020
E	1.500	1.700
E1	2.650	2.950
e	0.950(Basic)	
e1	1.800	2.000
L	0.300	0.600
θ	0°	8°

Package outline dimensions
SOT-23-5L

Symbol	Dimensions In Millimeters	
	Min.	Max.
A	1.050	1.250
A1	0.000	0.100
A2	1.050	1.150
b	0.300	0.500
c	0.100	0.200
D	2.820	3.020
E	1.500	1.700
E1	2.650	2.950
e	0.950(Basic)	
e1	1.800	2.000
L	0.300	0.600
θ	0°	8°

Order Information

Ordering No.	Vout (V)	Package	Operating Temperature	Marking	Shipping
WL2805N12-3/TR	1.2	SOT-23-3L	-40~+85°C	FBC*	3000 Tape & Reel
WL2805N13-3/TR	1.3	SOT-23-3L	-40~+85°C	F13*	3000 Tape & Reel
WL2805N15-3/TR	1.5	SOT-23-3L	-40~+85°C	F15*	3000 Tape & Reel
WL2805N18-3/TR	1.8	SOT-23-3L	-40~+85°C	F18*	3000 Tape & Reel
WL2805N20-3/TR	2.0	SOT-23-3L	-40~+85°C	F20*	3000 Tape & Reel
WL2805N25-3/TR	2.5	SOT-23-3L	-40~+85°C	FCF*	3000 Tape & Reel
WL2805N28-3/TR	2.8	SOT-23-3L	-40~+85°C	FCJ*	3000 Tape & Reel
WL2805N30-3/TR	3.0	SOT-23-3L	-40~+85°C	F30*	3000 Tape & Reel
WL2805N33-3/TR	3.3	SOT-23-3L	-40~+85°C	F33*	3000 Tape & Reel
WL2805E12-5/TR	1.2	SOT-23-5L	-40~+85°C	WF12 YYWW	3000 Tape & Reel
WL2805E13-5/TR	1.3	SOT-23-5L	-40~+85°C	WF13 YYWW	3000 Tape & Reel
WL2805E15-5/TR	1.5	SOT-23-5L	-40~+85°C	WF15 YYWW	3000 Tape & Reel
WL2805E18-5/TR	1.8	SOT-23-5L	-40~+85°C	WF18 YYWW	3000 Tape & Reel
WL2805E25-5/TR	2.5	SOT-23-5L	-40~+85°C	WF25 YYWW	3000 Tape & Reel
WL2805E28-5/TR	2.8	SOT-23-5L	-40~+85°C	WF28 YYWW	3000 Tape & Reel
WL2805E30-5/TR	3.0	SOT-23-5L	-40~+85°C	WF30 YYWW	3000 Tape & Reel
WL2805E33-5/TR	3.3	SOT-23-5L	-40~+85°C	WF33 YYWW	3000 Tape & Reel

Marking:

- F12 = Device code
- * = Month code (A~Z)
- WF12 = Device code
- YY = Year
- WW = Week