



General Description

FIR7N60FG is an N-channel enhancement mode power MOS field effect transistor which is produced using proprietary F-Cell™ structure VDMOS technology. The improved planar stripe cell and the improved guard ring terminal have been especially tailored to minimize on-state resistance, provide superior switching performance, and withstand high energy pulse in the avalanche and commutation mode.

These devices are widely used in AC-DC power suppliers, DC-DC converters and H-bridge PWM motor drivers.

Features

- 7A,600V, $R_{DS(on)}$ (typ) = 1.0 Ω @ $V_{GS}=10V$
- Low gate charge
- Low Crss
- Fast switching
- Improved dv/dt capability

PIN Connection TO-220F

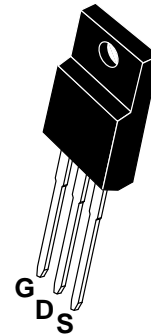

Schematic diagram

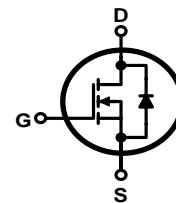

Marking Diagram



- Y = Year
- A = Assembly Location
- WW = Work Week
- VT = Version & Thickness
- FIR7N60F = Specific Device Code

Absolute Maximum Ratings (Ta = 25°C unless otherwise noted)

Characteristics	Symbol	Ratings	Unit
Drain-Source Voltage	V_{DS}	600	V
Gate-Source Voltage	V_{GS}	± 30	V
Drain Current	I_D	$T_C=25^\circ C$	7.0
		$T_C=100^\circ C$	4.0
Drain Current Pulsed	I_{DM}	28	A
Power Dissipation($T_C=25^\circ C$) -Derate above 25°C	P_D	45	W
		0.36	W/°C
Single Pulsed Avalanche Energy (Note 1)	E_{AS}	489	mJ
Operation Junction Temperature Range	T_J	-55~+150	°C
Storage Temperature Range	T_{stg}	-55~+150	°C



Thermal Characteristics

Characteristics	Symbol	Ratings	Unit
Thermal Resistance, Junction-to-Case	$R_{\theta JC}$	2.78	$^{\circ}C/W$
Thermal Resistance, Junction-to-Ambient	$R_{\theta JA}$	120	$^{\circ}C/W$

Electrical Characteristics (Ta = 25°C unless otherwise noted)

Characteristics	Symbol	Test conditions	Min.	Typ.	Max.	Unit
Drain -Source Breakdown Voltage	B_{VDSS}	25 °C, $V_{GS}=0V, I_D=250\mu A$	600	--	--	V
		125 °C, $V_{GS}=0V, I_D=250\mu A$	600	--	--	V
Drain-Source Leakage Current	I_{DSS}	25 °C, $V_{DS}=600V, V_{GS}=0V$	--	--	1	μA
		125 °C, $V_{DS}=600V, V_{GS}=0V$	--	--	50	μA
		150 °C, $V_{DS}=600V, V_{GS}=0V$	--	--	100	μA
Gate-Source Leakage Current	I_{GSS}	$V_{GS}=\pm 30V, V_{DS}=0V$	--	--	± 100	nA
Gate Threshold Voltage	$V_{GS(th)}$	$V_{GS}=V_{DS}, I_D=250\mu A$	2.5	--	3.8	V
Static Drain- Source On State Resistance	$R_{DS(on)}$	$V_{GS}=10V, I_D=3.5A$	--	1	1.4	Ω
Input Capacitance	C_{iss}	$V_{DS}=25V, V_{GS}=0V, f=1.0MHZ$	--	885	--	pF
Output Capacitance	C_{oss}		--	104	--	
Reverse Transfer Capacitance	C_{rss}		--	3.8	--	
Turn-on Delay Time	$t_{d(on)}$	$V_{DD}=300V, I_D=7.0A, R_G=25\Omega$ (Note 2,3)	--	27.33	--	ns
Turn-on Rise Time	t_r		--	58.40	--	
Turn-off Delay Time	$t_{d(off)}$		--	42.13	--	
Turn-off Fall Time	t_f		--	31.20	--	
Total Gate Charge	Q_g	$V_{DS}=480V, I_D=7.0A, V_{GS}=10V$ (Note 2,3)	--	15.16	--	nC
Gate-Source Charge	Q_{gs}		--	5.08	--	
Gate-Drain Charge	Q_{gd}		--	4.95	--	

Source-Drain Diode Ratings And Characteristics

Characteristics	Symbol	Test conditions	Min.	Typ.	Max.	Unit
Continuous Source Current	I_S	Integral Reverse P-N Junction Diode in the MOSFET	--	--	7.0	A
Pulsed Source Current	I_{SM}		--	--	28	
Diode Forward Voltage	V_{SD}	$I_S=7.0A, V_{GS}=0V$	--	--	1.2	V
Reverse Recovery Time	T_{rr}	$I_S=7.0A, V_{GS}=0V, dl_F/dt=100A/\mu S$	--	500	--	ns
Reverse Recovery Charge	Q_{rr}		--	3.4	--	μC

Notes:

- $L=30mH, I_{AS}=5.16A, V_{DD}=159V, R_G=25\Omega, starting T_J=25^{\circ}C;$
- Pulse Test: Pulse width $\leq 300\mu s, Duty\ cycle \leq 2\%;$
- Essentially independent of operating temperature.



Typical Characteristics

Figure 1. On-Region Characteristics

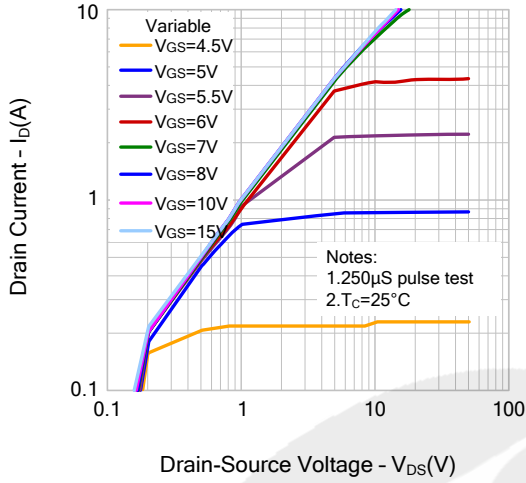

Figure 2. Transfer Characteristics

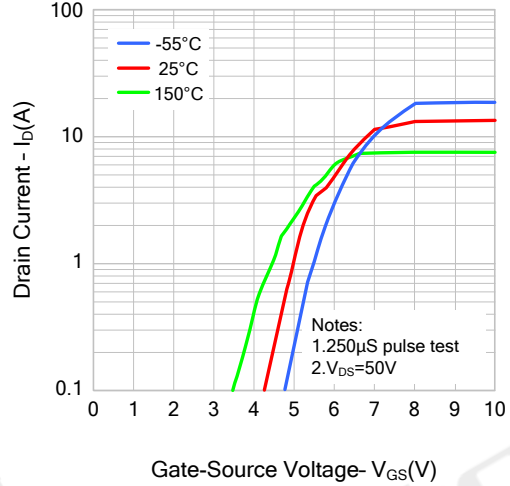

Figure 3. On-Resistance Variation vs. Drain Current and Gate Voltage

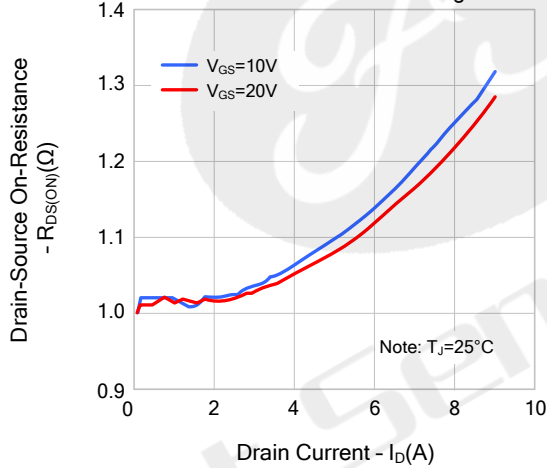

Figure 4. Body Diode Forward Voltage Variation vs. Source Current and Temperature

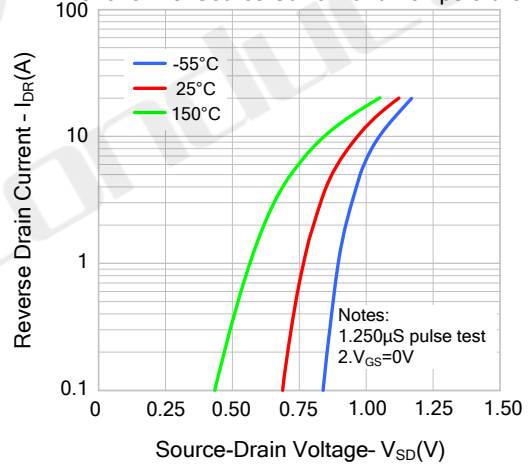

Figure 5. Capacitance Characteristics

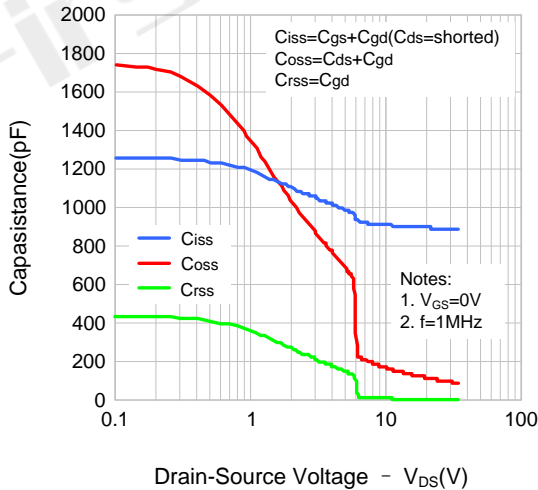
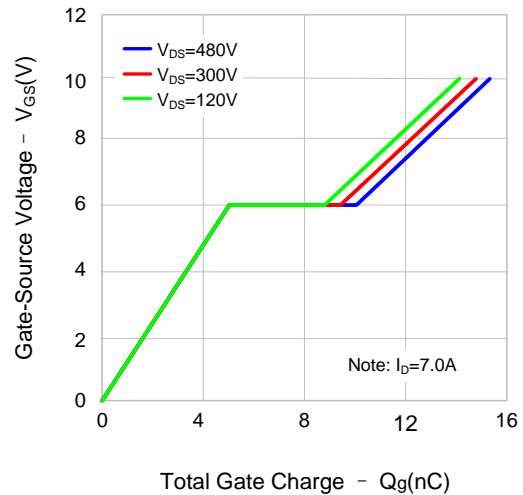

Figure 6. Gate Charge Characteristics





Typical Characteristics(Continued)

Figure 7. Breakdown Voltage Variation vs. Temperature

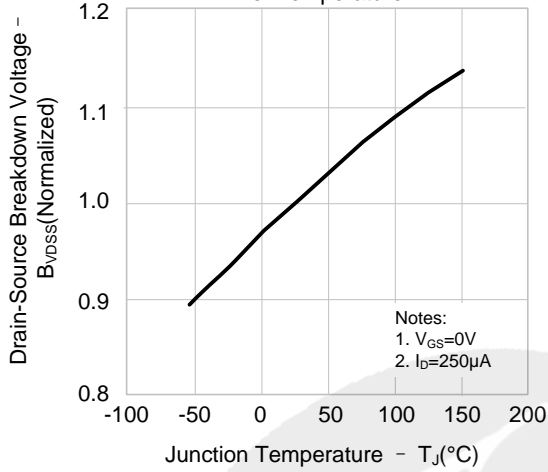

Figure 8. On-resistance Variation vs. Temperature

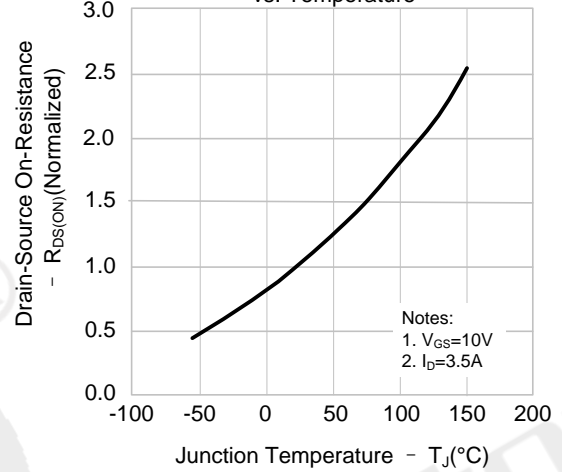

Figure 9. Max. Safe Operating Area(FIR7N60FG)

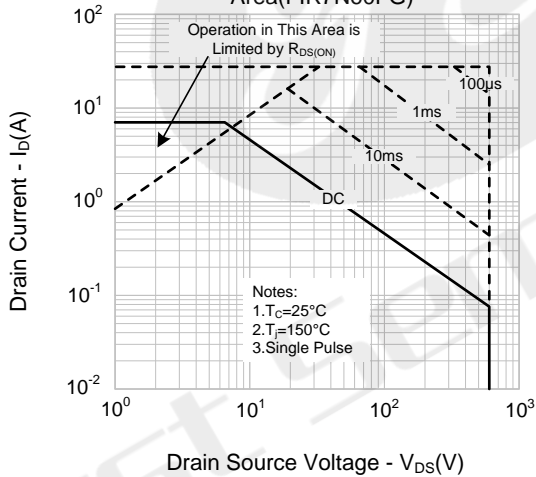
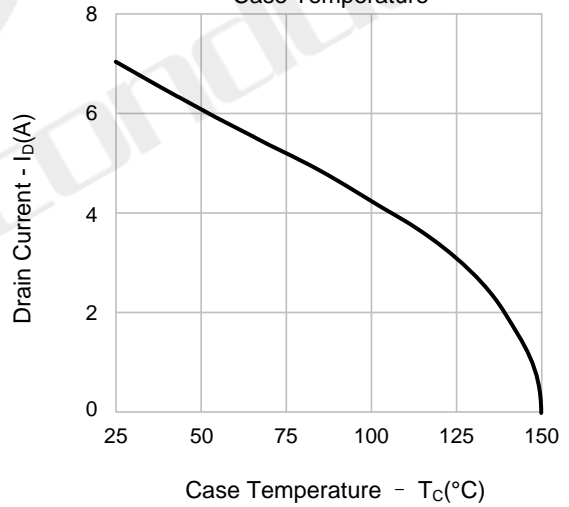
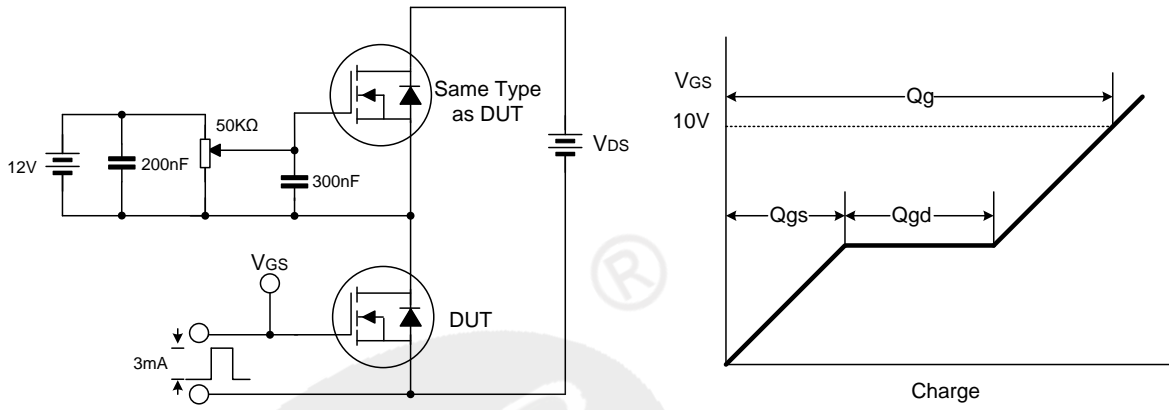

Figure 10. Maximum Drain Current vs. Case Temperature



Typical Test Circuit

Gate Charge Test Circuit & Waveform



Resistive Switching Test Circuit & Waveform

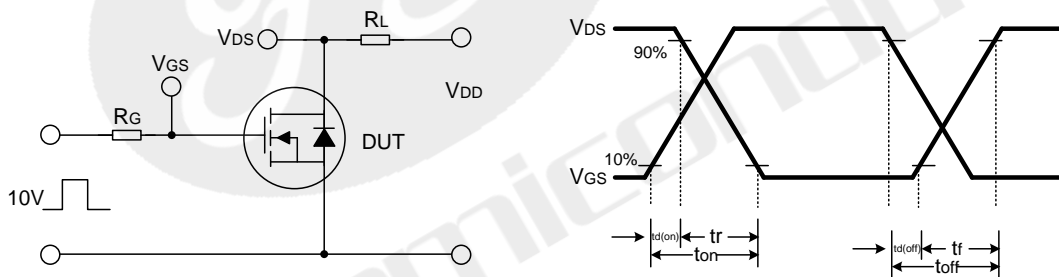

Unclamped Inductive Switching Test Circuit & Waveform

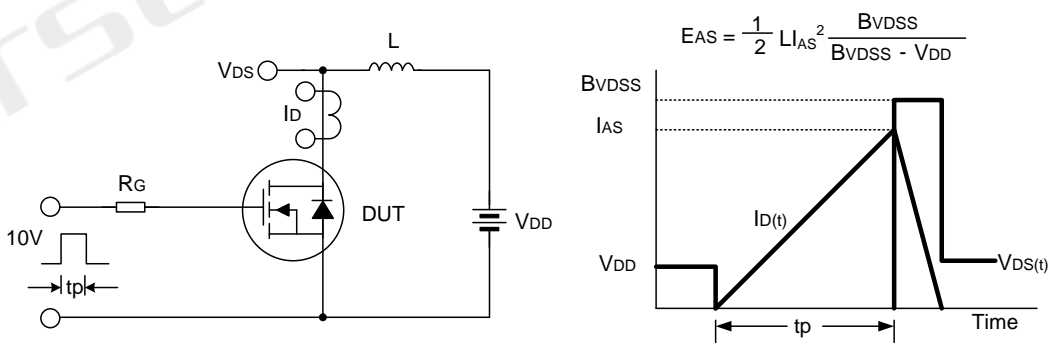



Package Dimensions

TO-220F

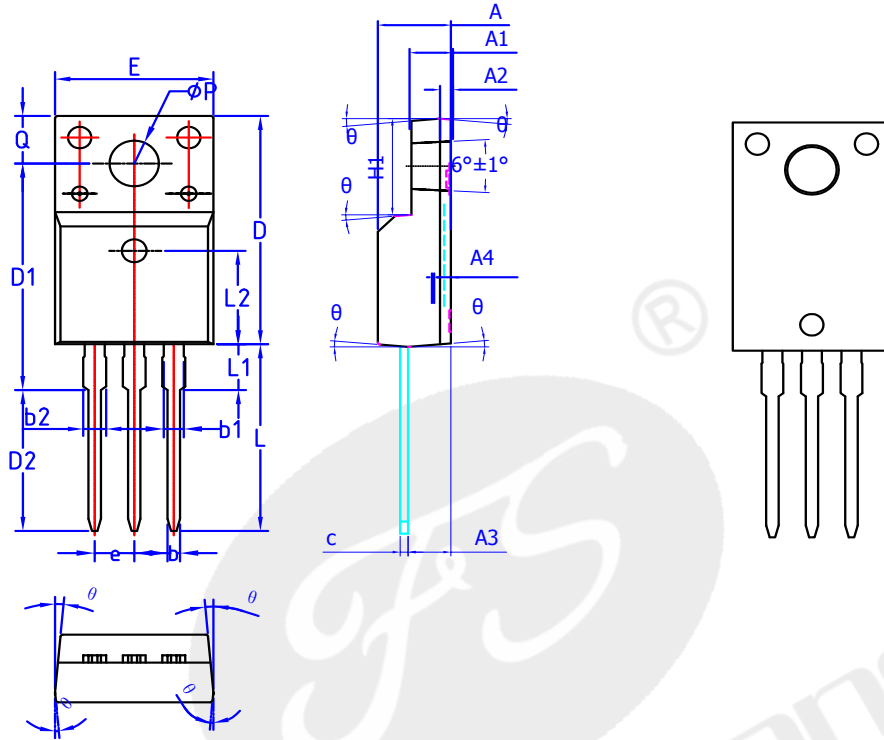

Units: mm
COMMON DIMENSIONS
(UNITS OF MEASURE=MILLIMETER)

SYMBOL	MIN	NOM	MAX
A	4.50	4.70	4.90
A1	2.34	2.54	2.74
A2	0.70 REF		
A3	2.56	2.76	2.96
b	0.70	0.80	0.90
b1	1.17	1.2	1.25
b2	1.17	1.2	1.25
c	0.45	0.50	0.60
D	15.67	15.87	16.07
D1	15.55	15.75	15.95
D2	10.0	10.2	10.4
E	9.96	10.16	10.36
e	2.54BSC		
H1	6.48	6.68	6.88
L	12.68	12.98	13.28
L1	-	-	3.50
L2	6.50REF		
φP	3.08	3.18	3.28
Q	3.20	3.30	3.40
φ 1	1°	3°	5°
A4	0.53	0.56	0.59



Declaration

- FIRST reserves the right to change the specifications, the same specifications of products due to different packaging line mold, the size of the appearance will be slightly different, shipped in kind, without notice! Customers should obtain the latest version information before ordering, and verify whether the relevant information is complete and up-to-date.
- Any semiconductor product under certain conditions has the possibility of failure or failure, The buyer has the responsibility to comply with safety standards and take safety measures when using FIRST products for system design and manufacturing, To avoid To avoid potential failure risks, which may cause personal injury or property damage!
- Product promotion endless, our company will wholeheartedly provide customers with better products!

ATTACHMENT

Revision History

Date	REV	Description	Page
2018.01.01	1.0	Initial release	