

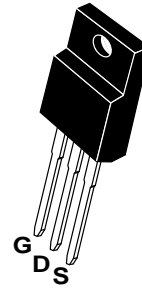

**Features:**

- Low Intrinsic Capacitances.
- Excellent Switching Characteristics.
- Extended Safe Operating Area.
- Unrivalled Gate Charge :Qg=75 nC (Typ.).
- BVDSS=650V, I<sub>D</sub>=20A
- R<sub>DS(on)</sub> : 0.42Ω (Max) @V<sub>G</sub>=10V
- 100% Avalanche Tested

**PIN Connection TO-220F**



**Schematic diagram**

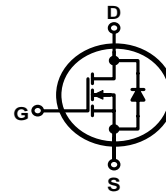

**Marking Diagram**



- Y = Year
- A = Assembly Location
- WW = Work Week
- FIR20N65AF = Specific Device Code

**Absolute Maximum Ratings (Ta=25°C unless otherwise noted)**

Symbol	Parameter	Value	Unit
V <sub>DSS</sub>	Drain-Source Voltage	650	V
I <sub>D</sub>	Drain Current	T <sub>C</sub> =25°C	20
		T <sub>C</sub> =100°C	12.5
V <sub>GS(TH)</sub>	Gate Threshold Voltage	±30	V
E <sub>AS</sub>	Single Pulse Avalanche Energy (note1)	1020	mJ
I <sub>AR</sub>	Avalanche Current (note2)	20	A
P <sub>D</sub>	Power Dissipation (Tc=25°C)	239	W
T <sub>j</sub>	Junction Temperature(Max)	150	°C
T <sub>stg</sub>	Storage Temperature	-55~+150	
TL	Maximum lead temperature for soldering purpose, 1/8" from case for 5 seconds	300	

**Thermal Characteristics**

Symbol	Parameter	Typ.	Max.	Unit
R <sub>θJC</sub>	Thermal Resistance, Junction to Case	-	0.52	°C/W
R <sub>θJA</sub>	Thermal Resistance, Junction to Ambient	-	120	



**Electrical Characteristics** (Ta=25°C unless otherwise noted)

Symbol	Parameter	Test Condition	Min.	Typ.	Max.	Unit
<b>Off Characteristics</b>						
BV <sub>DSS</sub>	Drain-Source Breakdown Voltage	I <sub>D</sub> =250μA, V <sub>GS</sub> =0	650	-	-	V
ΔBV <sub>DSS</sub> /ΔT <sub>J</sub>	Breakdown Voltage Temperature Coefficient	I <sub>D</sub> =250μA, Reference to 25°C	-	0.71	-	V/°C
I <sub>DSS</sub>	Zero Gate Voltage Drain Current	V <sub>DS</sub> =650V, V <sub>GS</sub> =0V V <sub>DS</sub> =520V, T <sub>c</sub> =125°C	-	-	10 100	μA
I <sub>GSSF</sub>	Gate-body leakage Current, Forward	V <sub>GS</sub> =+30V, V <sub>DS</sub> =0V	-	-	100	nA
I <sub>GSSR</sub>	Gate-body leakage Current, Reverse	V <sub>GS</sub> =-30V, V <sub>DS</sub> =0V	-	-	-100	
<b>On Characteristics</b>						
V <sub>GS(TH)</sub>	Gate Threshold Voltage	I <sub>D</sub> =250μA, V <sub>DS</sub> =V <sub>GS</sub>	2	-	4	V
R <sub>DS(ON)</sub>	Static Drain-Source On-Resistance	I <sub>D</sub> =10A, V <sub>GS</sub> =10V	-	-	0.42	Ω
<b>Dynamic Characteristics</b>						
C <sub>iss</sub>	Input Capacitance	V <sub>DS</sub> =25V, V <sub>GS</sub> =0, f=1.0MHz	-	3520	-	pF
C <sub>oss</sub>	Output Capacitance		-	1280	-	
C <sub>rss</sub>	Reverse Transfer Capacitance		-	95	-	
<b>Switching Characteristics</b>						
T <sub>d(on)</sub>	Turn-On Delay Time	V <sub>DD</sub> =325V, I <sub>D</sub> =20A R <sub>G</sub> =25Ω (Note 3,4)	-	62	135	ns
T <sub>r</sub>	Turn-On Rise Time		-	140	290	
T <sub>d(off)</sub>	Turn-Off Delay Time		-	230	470	
T <sub>f</sub>	Turn-Off Rise Time		-	65	140	
Q <sub>g</sub>	Total Gate Charge	V <sub>DS</sub> =520, V <sub>GS</sub> =10V, I <sub>D</sub> =20A (Note 3,4)	-	75	98	nC
Q <sub>gs</sub>	Gate-Source Charge		-	13.5	18	
Q <sub>gd</sub>	Gate-Drain Charge		-	36	-	
<b>Drain-Source Diode Characteristics and Maximum Ratings</b>						
I <sub>s</sub>	Max. Diode Forward Current	-	-	-	20	A
I <sub>SM</sub>	Max. Pulsed Forward Current	-	-	-	80	
V <sub>SD</sub>	Diode Forward Voltage	I <sub>D</sub> =20A	-	-	1.4	V
T <sub>rr</sub>	Reverse Recovery Time	I <sub>S</sub> =20A, V <sub>GS</sub> =0V diF/dt=100A/μs	-	530	-	nS
Q <sub>rr</sub>	Reverse Recovery Charge	(Note3)	-	10.5	-	μC

- Notes : 1, L=3.45mH, I<sub>AS</sub>=20A, V<sub>DD</sub>=50V, R<sub>G</sub>=25Ω, Starting T<sub>J</sub>=25°C  
 2, Repetitive Rating : Pulse width limited by maximum junction temperature  
 3, Pulse Test : Pulse Width ≤ 300μs, Duty Cycle ≤ 2%  
 4, Essentially Independent of Operating Temperature



# Typical Characteristics

Figure 1. On-Region Characteristics

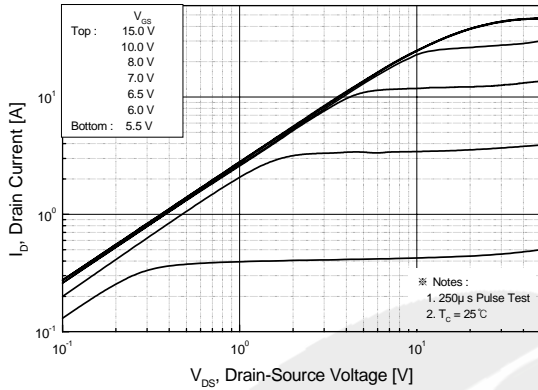

Figure 2. Transfer Characteristics

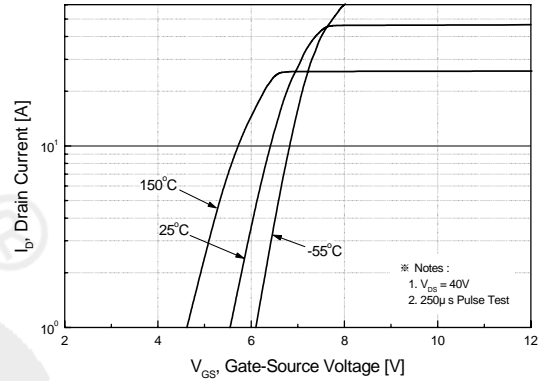

Figure 3. On-Resistance Variation vs. Drain Current and Gate Voltage

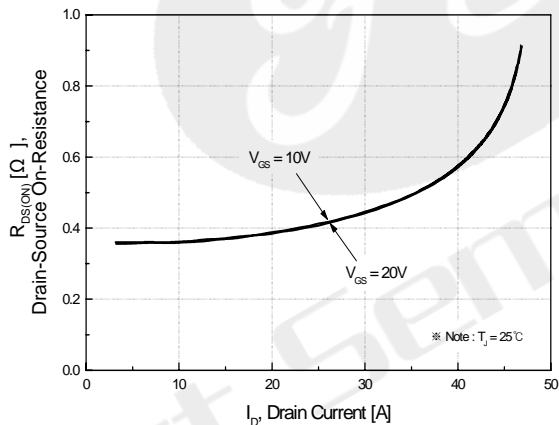

Figure 4. Body Diode Forward Voltage Variation vs. Source Current and Temperature

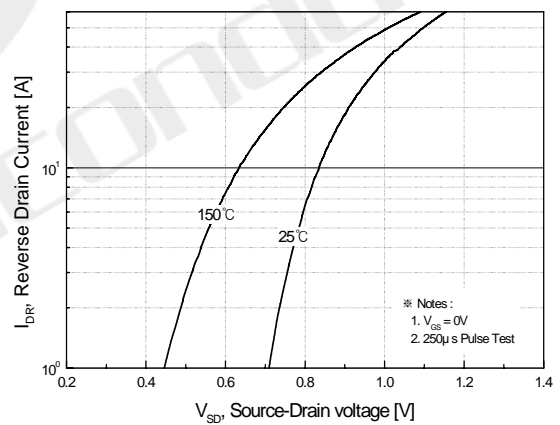

Figure 5. Capacitance Characteristics

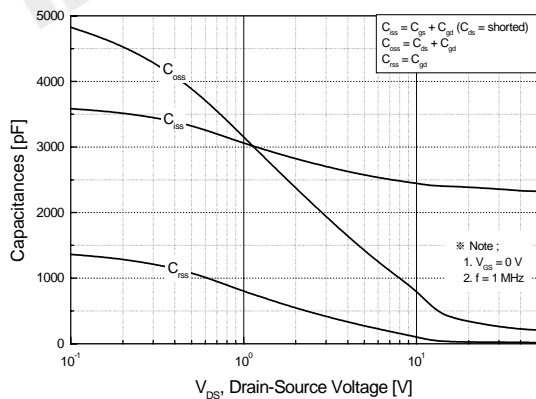
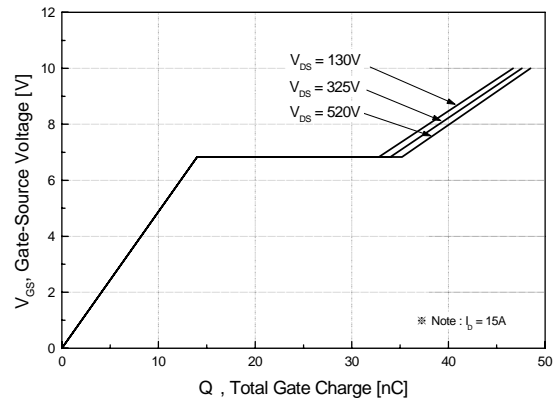

Figure 6. Gate Charge Characteristics





Typical Characteristics (Continued)

Figure 7. Breakdown Voltage Variation vs. Temperature

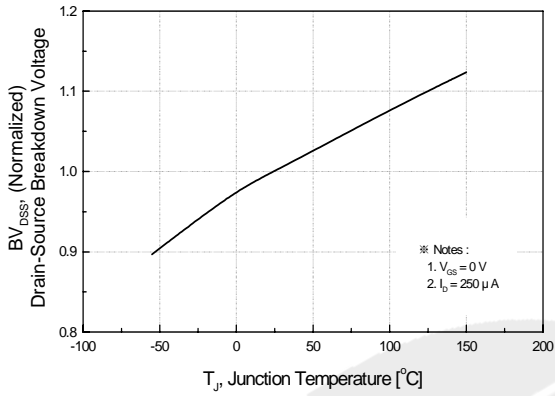

Figure 8. On-Resistance Variation vs. Temperature

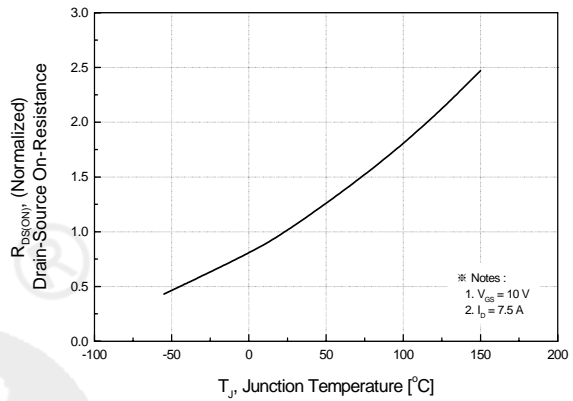

Figure 9-2. Safe Operating Area

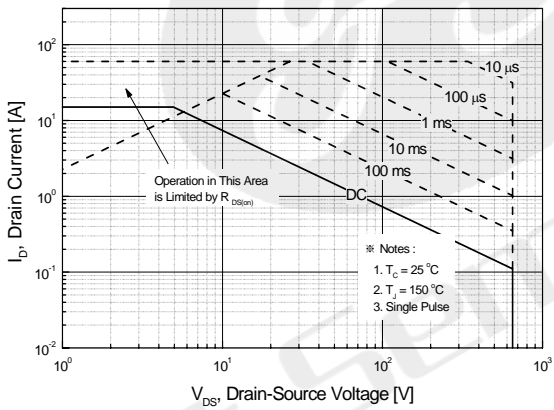

Figure 10. Maximum Drain Current vs. Case Temperature

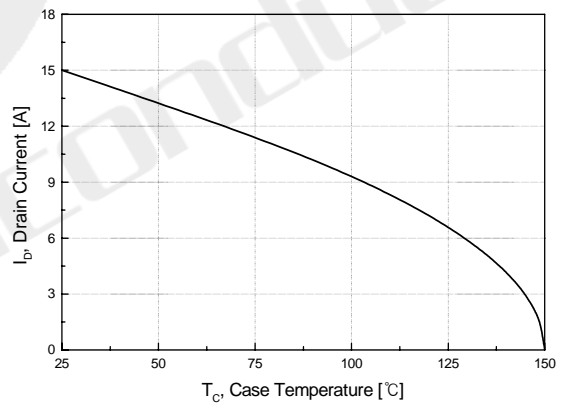
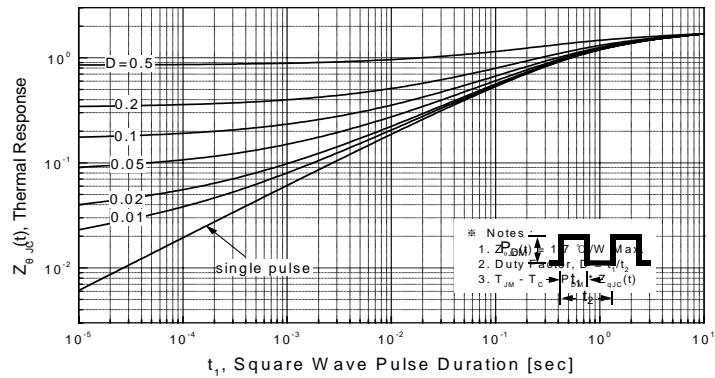
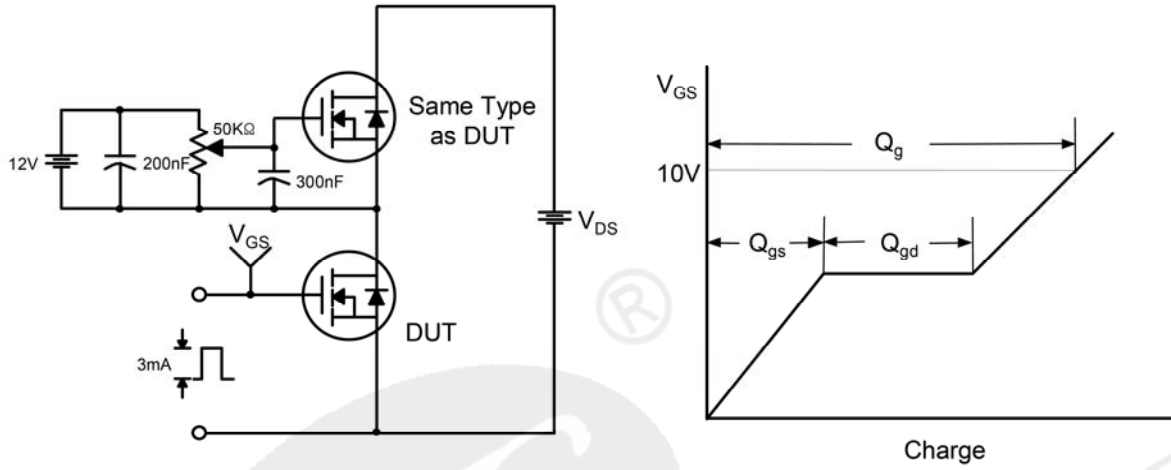

Figure 11-2. Transient Thermal Response Curve



**Gate Charge Test Circuit & Waveform**



**Resistive Switching Test Circuit & Waveforms**

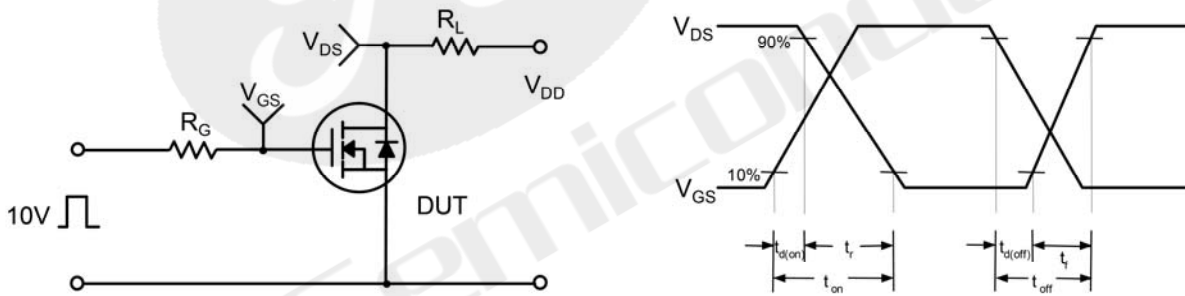

**Unclamped Inductive Switching Test Circuit & Waveforms**

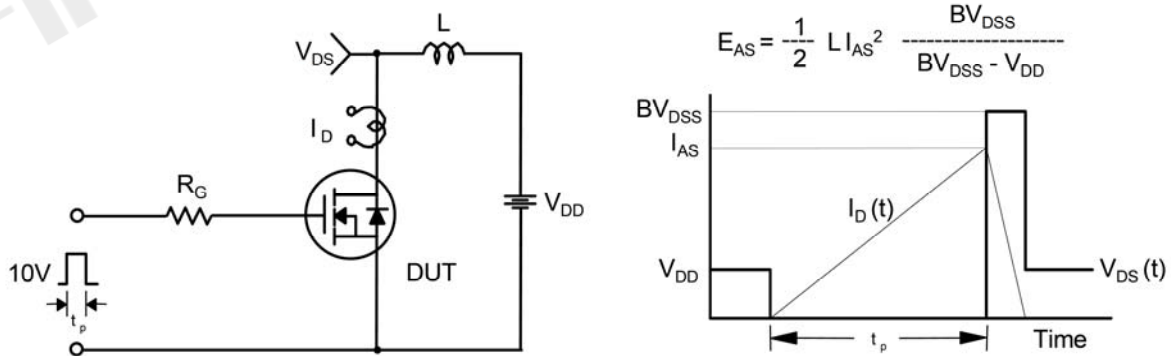

Peak Diode Recovery dv/dt Test Circuit & Waveform

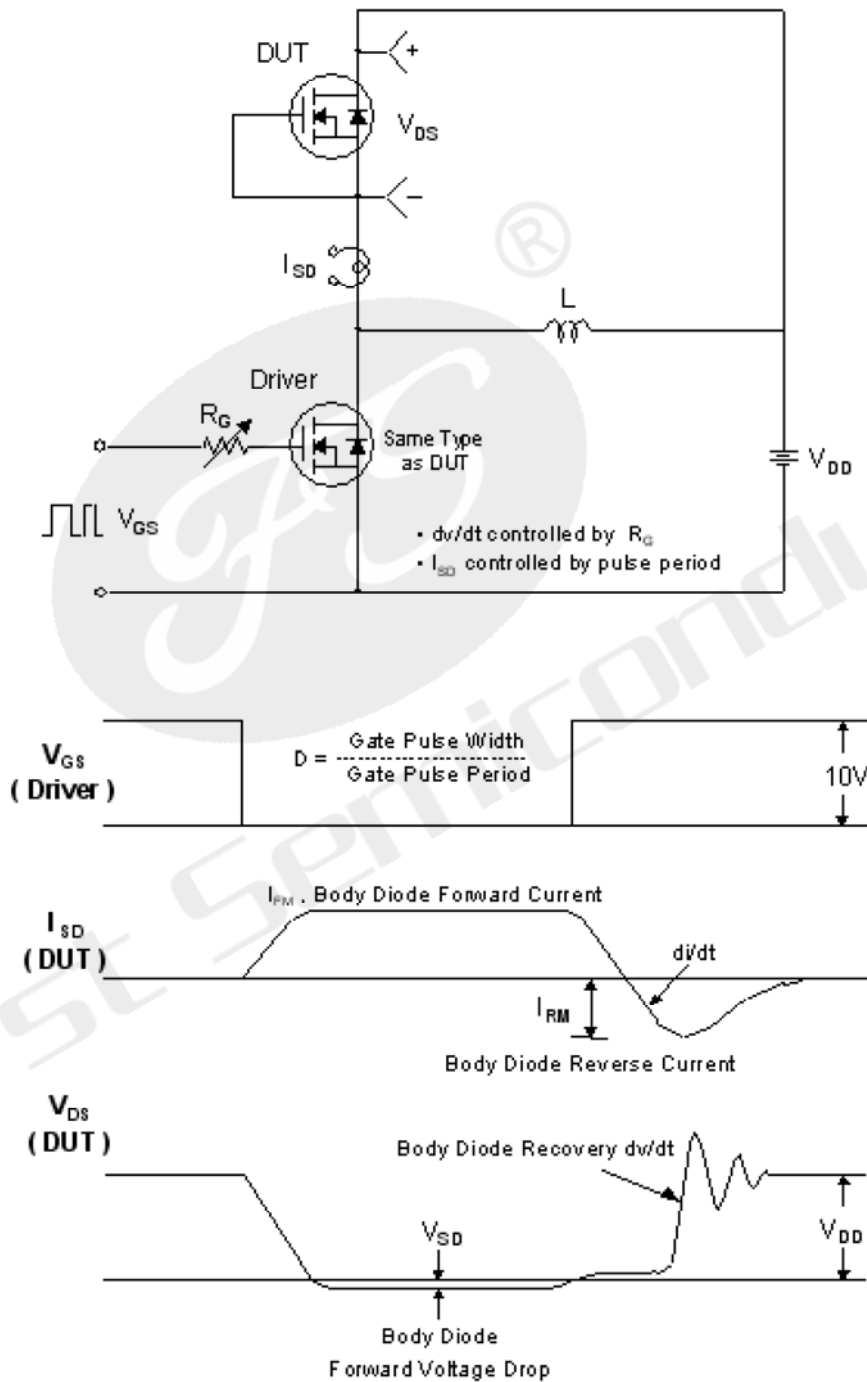



**Package Dimension**

Unit: mm

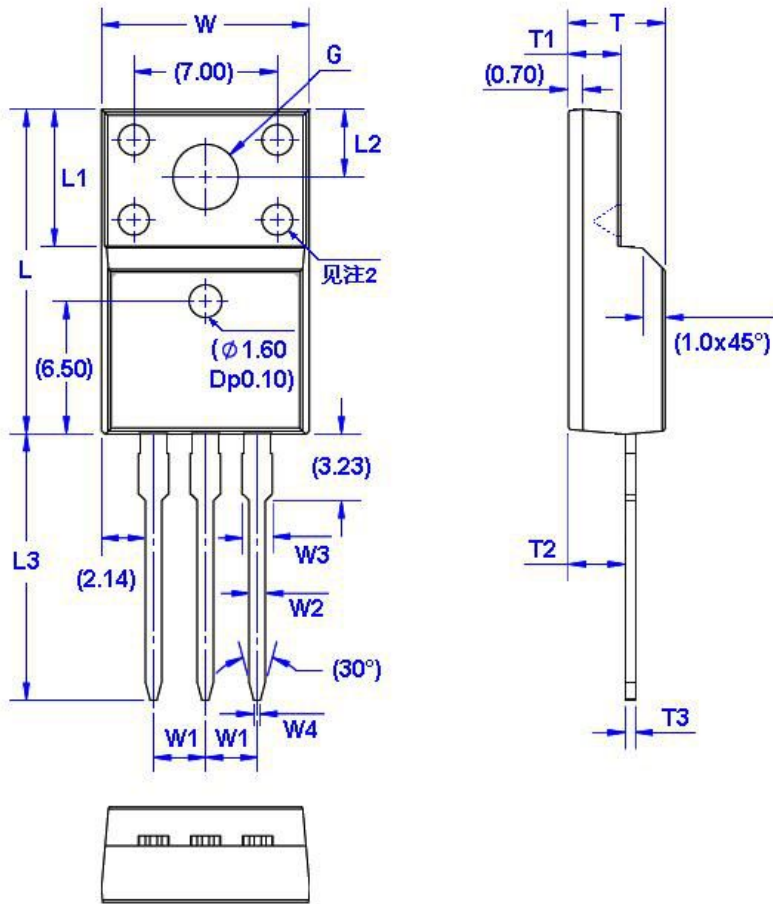

Symbol	Size		Symbol	Size		Symbol	Size		Symbol	Size	
	Min	Max		Min	Max		Min	Max		Min	Max
W	9.96	10.36	W4	0.25	0.45	L3	12.78	13.18	T3	0.45	0.60
W1	2.54 (TYP)		L	15.67	16.07	T	4.50	4.90	G( $\Phi$ )	3.08	3.28
W2	0.70	0.90	L1	6.48	6.88	T1	2.34	2.74			
W3	1.24	1.47	L2	3.20	3.40	T2	2.56	2.96			



Declaration

- FIRST reserves the right to change the specifications, the same specifications of products due to different packaging line mold, the size of the appearance will be slightly different, shipped in kind, without notice! Customers should obtain the latest version information before ordering, and verify whether the relevant information is complete and up-to-date.
- Any semiconductor product under certain conditions has the possibility of failure or failure, The buyer has the responsibility to comply with safety standards and take safety measures when using FIRST products for system design and manufacturing, To avoid To avoid potential failure risks, which may cause personal injury or property damage!
- Product promotion endless, our company will wholeheartedly provide customers with better products!

**ATTACHMENT**

Revision History

Date	REV	Description	Page
2018.01.01	1.0	Initial release	