

Zener Diodes

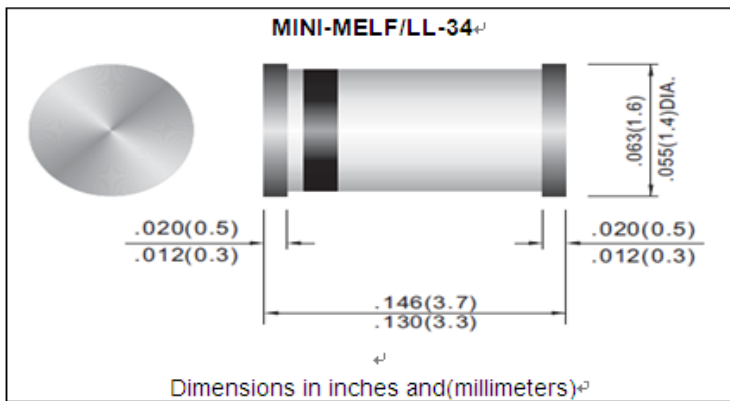

Features

- P_{tot} 500mW
- V_Z 2.4V-75V

■ Limiting Values (Absolute Maximum Rating)

Item	Symbol	Unit	Conditions	Max
Power dissipation	P_{tot}	mW	$L=4mm, T_L=25^\circ C$	500
Zener current	I_Z	mA	P_{tot} / V_Z	See Table
Maximum junction temperature	T_j	$^\circ C$		175
Storage temperature range	T_{stg}	$^\circ C$		-65 to +175

■ Electrical Characteristics ($T_a=25^\circ C$ Unless otherwise specified)

Item	Symbol	Unit	Conditions	Max
Thermal resistance	$R_{\theta JA}$	$^\circ C/W$	junction to ambient air, on PC board 50mm×50mm×1.6mm	300
Forward voltage	V_F	V	$I_F=200mA$	1.5



ZMM55 SERIES

■ Electrical Characteristics (T_A=25°C unless otherwise noted)

Part Number	Zener voltage range		Dynamic resistance		Test current	Temperature Coefficient		Test current	Reverse leakage current		
	V _Z at I _{ZT}		R _{ZJT} at I _{ZT}	R _{ZJK} at I _{ZK}	I _{ZT}	TK _{VZ}		I _{ZK}	I _R	I _R ¹⁾	at V _R
	V		Ω		mA	% / K		mA	μA		V
	Min.	Max.				Min.	Max.				
ZMM55C2V0	1.9	2.1	< 100	< 600	5	- 0.09	- 0.06	1	< 150	< 300	1
ZMM55C2V4	2.28	2.56	< 85	< 600	5	- 0.09	- 0.06	1	< 50	< 100	1
ZMM55C2V7	2.5	2.9	< 85	< 600	5	- 0.09	- 0.06	1	< 10	< 50	1
ZMM55C3V0	2.8	3.2	< 85	< 600	5	- 0.08	- 0.05	1	< 4	< 40	1
ZMM55C3V3	3.1	3.5	< 85	< 600	5	- 0.08	- 0.05	1	< 2	< 40	1
ZMM55C3V6	3.4	3.8	< 85	< 600	5	- 0.08	- 0.05	1	< 2	< 40	1
ZMM55C3V9	3.7	4.1	< 85	< 600	5	- 0.08	- 0.05	1	< 2	< 40	1
ZMM55C4V3	4	4.6	< 75	< 600	5	- 0.06	- 0.03	1	< 1	< 20	1
ZMM55C4V7	4.4	5	< 60	< 600	5	- 0.05	0.02	1	< 0.5	< 10	1
ZMM55C5V1	4.8	5.4	< 35	< 550	5	- 0.02	0.02	1	< 0.1	< 2	1
ZMM55C5V6	5.2	6	< 25	< 450	5	- 0.05	0.05	1	< 0.1	< 2	1
ZMM55C6V2	5.8	6.6	< 10	< 200	5	0.03	0.06	1	< 0.1	< 2	2
ZMM55C6V8	6.4	7.2	< 8	< 150	5	0.03	0.07	1	< 0.1	< 2	3
ZMM55C7V5	7	7.9	< 7	< 50	5	0.03	0.07	1	< 0.1	< 2	5
ZMM55C8V2	7.7	8.7	< 7	< 50	5	0.03	0.08	1	< 0.1	< 2	6.2
ZMM55C9V1	8.5	9.6	< 10	< 50	5	0.03	0.09	1	< 0.1	< 2	6.8
ZMM55C10	9.4	10.6	< 15	< 70	5	0.03	0.1	1	< 0.1	< 2	7.5
ZMM55C11	10.4	11.6	< 20	< 70	5	0.03	0.11	1	< 0.1	< 2	8.2
ZMM55C12	11.4	12.7	< 20	< 90	5	0.03	0.11	1	< 0.1	< 2	9.1



ZMM55 SERIES

ZMM55C13	12.4	14.1	< 26	< 110	5	0.03	0.11	1	< 0.1	< 2	10
ZMM55C15	13.8	15.6	< 30	< 110	5	0.03	0.11	1	< 0.1	< 2	11
ZMM55C16	15.3	17.1	< 40	< 170	5	0.03	0.11	1	< 0.1	< 2	12
ZMM55C18	16.8	19.1	< 50	< 170	5	0.03	0.11	1	< 0.1	< 2	13
ZMM55C20	18.8	21.2	< 55	< 220	5	0.03	0.11	1	< 0.1	< 2	15
ZMM55C22	20.8	23.3	< 55	< 220	5	0.04	0.12	1	< 0.1	< 2	16
ZMM55C24	22.8	25.6	< 80	< 220	5	0.04	0.12	1	< 0.1	< 2	18
ZMM55C27	25.1	28.9	< 80	< 220	5	0.04	0.12	1	< 0.1	< 2	20
ZMM55C30	28	32	< 80	< 220	5	0.04	0.12	1	< 0.1	< 2	22
ZMM55C33	31	35	< 80	< 220	5	0.04	0.12	1	< 0.1	< 2	24
ZMM55C36	34	38	< 80	< 220	5	0.04	0.12	1	< 0.1	< 2	27
ZMM55C39	37	41	< 90	< 500	2.5	0.04	0.12	0.5	< 0.1	< 5	30
ZMM55C43	40	46	< 90	< 600	2.5	0.04	0.12	0.5	< 0.1	< 5	33
ZMM55C47	44	50	< 110	< 700	2.5	0.04	0.12	0.5	< 0.1	< 5	36
ZMM55C51	48	54	< 125	< 700	2.5	0.04	0.12	0.5	< 0.1	< 10	39
ZMM55C56	52	60	< 135	< 1000	2.5	0.04	0.12	0.5	< 0.1	< 10	43
ZMM55C62	58	66	< 150	< 1000	2.5	0.04	0.12	0.5	< 0.1	< 10	47
ZMM55C68	64	72	< 200	< 1000	2.5	0.04	0.12	0.5	< 0.1	< 10	51
ZMM55C75	70	79	< 250	< 1500	2.5	0.04	0.12	0.5	< 0.1	< 10	56

Notes:

Additional measurement of voltage group ZMM55C9V1 to ZMM55C75,IR at 95% $V_{Zmin} \leq 35nA$ at $T_J=25^{\circ}C$
 $T_J=150^{\circ}C$



ZMM55 SERIES

■Electrical Characteristics (T_A=25°C unless otherwise noted)

Part Number	Zener voltage range		Dynamic resistance		Test current	Temperature Coefficient		Test current	Reverse leakage current		
	V _Z at I _{ZT}		R _{ZJT} at I _{ZT}	R _{ZJK} at I _{ZK}	I _{ZT}	TK _{VZ}		I _{ZK}	I _R	I _R ¹⁾	at V _R
	V		Ω		mA	% / K		mA	μA		V
	Min.	Max.				Min.	Max.				
ZMM55B2V4	2.35	2.45	< 85	< 600	5	- 0.09	- 0.06	1	< 50	< 100	1
ZMM55B2V7	2.64	2.76	< 85	< 600	5	- 0.09	- 0.06	1	< 10	< 50	1
ZMM55B3V0	2.94	3.06	< 90	< 600	5	- 0.08	- 0.05	1	< 4	< 40	1
ZMM55B3V3	3.24	3.36	< 90	< 600	5	- 0.08	- 0.05	1	< 2	< 40	1
ZMM55B3V6	3.52	3.68	< 90	< 600	5	- 0.08	- 0.05	1	< 2	< 40	1
ZMM55B3V9	3.82	3.98	< 90	< 600	5	- 0.08	- 0.05	1	< 2	< 40	1
ZMM55B4V3	4.22	4.38	< 90	< 600	5	- 0.06	- 0.03	1	< 1	< 20	1
ZMM55B4V7	4.6	4.8	< 80	< 600	5	- 0.05	0.02	1	< 0.5	< 10	1
ZMM55B5V1	5	5.2	< 60	< 550	5	- 0.02	0.02	1	< 0.1	< 2	1
ZMM55B5V6	5.48	5.72	< 40	< 450	5	- 0.05	0.05	1	< 0.1	< 2	1
ZMM55B6V2	6.08	6.32	< 10	< 200	5	0.03	0.06	1	< 0.1	< 2	2
ZMM55B6V8	6.66	6.94	< 8	< 150	5	0.03	0.07	1	< 0.1	< 2	3
ZMM55B7V5	7.35	7.65	< 7	< 50	5	0.03	0.07	1	< 0.1	< 2	5
ZMM55B8V2	8.04	8.36	< 7	< 50	5	0.03	0.08	1	< 0.1	< 2	6.2
ZMM55B9V1	8.92	9.28	< 10	< 50	5	0.03	0.09	1	< 0.1	< 2	6.8
ZMM55B10	9.8	10.2	< 15	< 70	5	0.03	0.1	1	< 0.1	< 2	7.5
ZMM55B11	10.78	11.22	< 20	< 70	5	0.03	0.11	1	< 0.1	< 2	8.2
ZMM55B12	11.76	12.24	< 20	< 90	5	0.03	0.11	1	< 0.1	< 2	9.1
ZMM55B13	12.74	13.26	< 26	< 110	5	0.03	0.11	1	< 0.1	< 2	10



ZMM55 SERIES

ZMM55B15	14.7	15.3	< 30	< 110	5	0.03	0.11	1	< 0.1	< 2	11
ZMM55B16	15.7	16.3	< 40	< 170	5	0.03	0.11	1	< 0.1	< 2	12
ZMM55B18	17.64	18.36	< 50	< 170	5	0.03	0.11	1	< 0.1	< 2	13
ZMM55B20	19.6	20.4	< 55	< 220	5	0.03	0.11	1	< 0.1	< 2	15
ZMM55B22	21.55	22.45	< 55	< 220	5	0.04	0.12	1	< 0.1	< 2	16
ZMM55B24	23.5	24.5	< 80	< 220	5	0.04	0.12	1	< 0.1	< 2	18
ZMM55B27	26.4	27.6	< 80	< 220	5	0.04	0.12	1	< 0.1	< 2	20
ZMM55B30	29.4	30.6	< 80	< 220	5	0.04	0.12	1	< 0.1	< 2	22
ZMM55B33	32.4	33.6	< 80	< 220	5	0.04	0.12	1	< 0.1	< 2	24
ZMM55B36	35.3	36.7	< 80	< 220	5	0.04	0.12	1	< 0.1	< 2	27
ZMM55B39	38.2	39.8	< 90	< 500	2.5	0.04	0.12	0.5	< 0.1	< 5	30
ZMM55B43	42.1	43.9	< 90	< 600	2.5	0.04	0.12	0.5	< 0.1	< 5	33
ZMM55B47	46.1	47.9	< 110	< 700	2.5	0.04	0.12	0.5	< 0.1	< 5	36
ZMM55B51	50	52	< 125	< 700	2.5	0.04	0.12	0.5	< 0.1	< 10	39
ZMM55B56	54.9	57.1	< 135	< 1000	2.5	0.04	0.12	0.5	< 0.1	< 10	43
ZMM55B62	60.8	63.2	< 150	< 1000	2.5	0.04	0.12	0.5	< 0.1	< 10	47
ZMM55B68	66.6	69.4	< 200	< 1000	2.5	0.04	0.12	0.5	< 0.1	< 10	51
ZMM55B75	73.5	76.5	< 250	< 1500	2.5	0.04	0.12	0.5	< 0.1	< 10	56

Notes:

Additional measurement of voltage group ZMM55B9V1 to ZMM55B75,IR at 95% $V_{Zmin} \leq 35nA$ at $T_j=25^\circ C$

$T_j=150^\circ C$



ZMM55 SERIES

■ Ordering Information (Example)

PREFERRED P/N	PACKING CODE	UNIT WEIGHT(g)	MINIMUM PACKAGE(pcs)	INNER BOX QUANTITY(pcs)	OUTER CARTON QUANTITY(pcs)	DELIVERY MODE
ZMM55 SERIES	F1	Approximate 0.47	10000	10000	50000	7" reel

■ Characteristics(Typical)

FIG1: Total Power Dissipation vs. Ambient Temperature

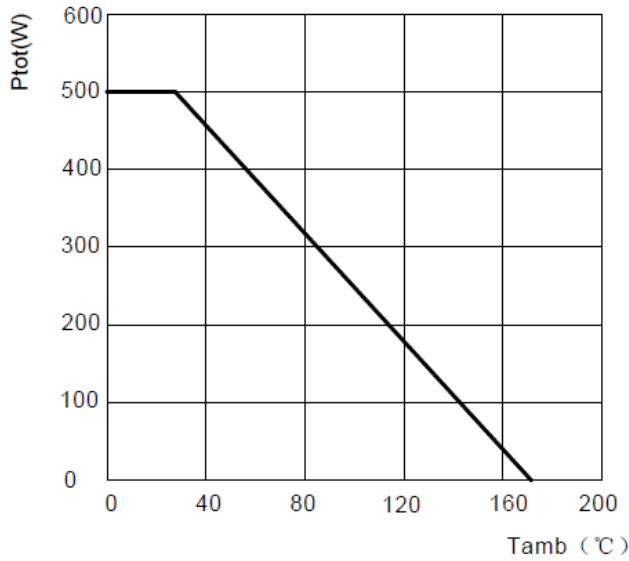

FIG2: Typical Change of Working Voltage under Operating Conditions at Tamb=25°C

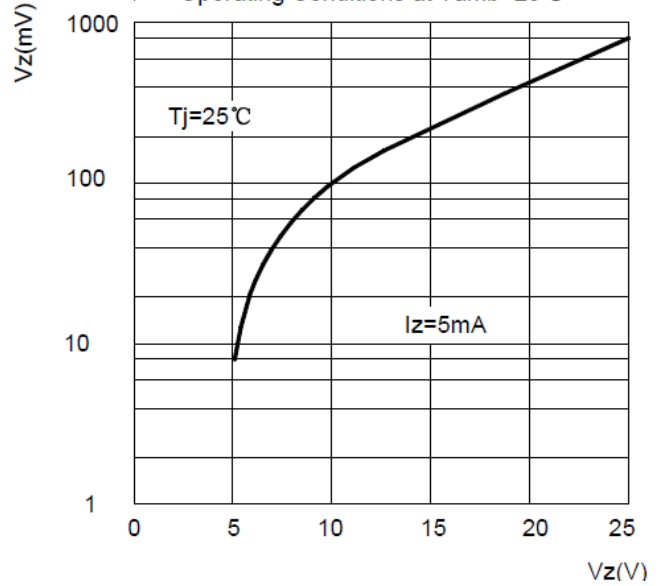

FIG3: Typical Change of Working Voltage vs. Junction Temperature

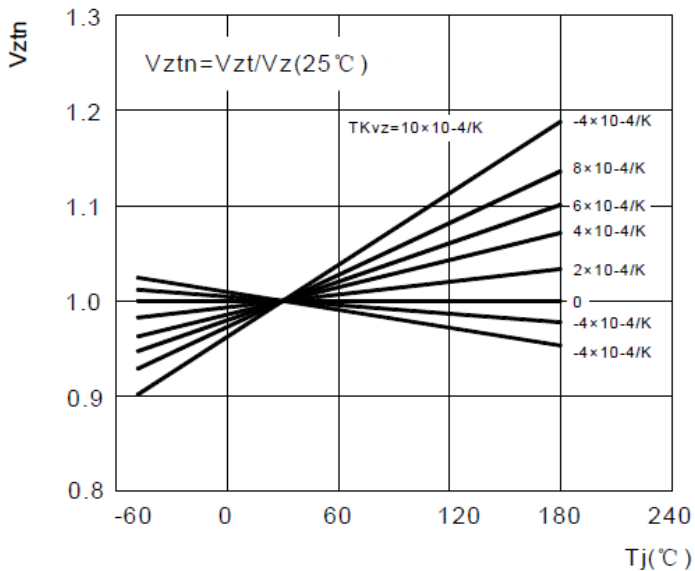
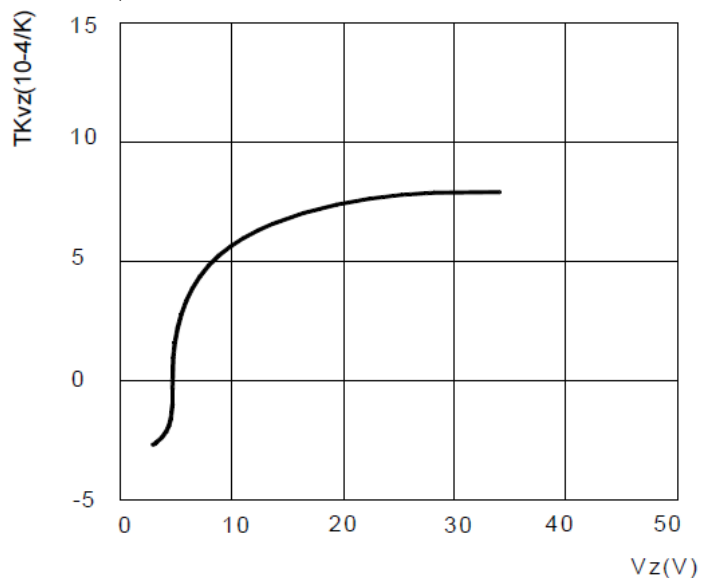

FIG4: Temperature Coefficient of Vz vs. Z-voltage





ZMM55 SERIES

■ Characteristics(Typical)

FIG5: Forward Current vs. Forward Voltage

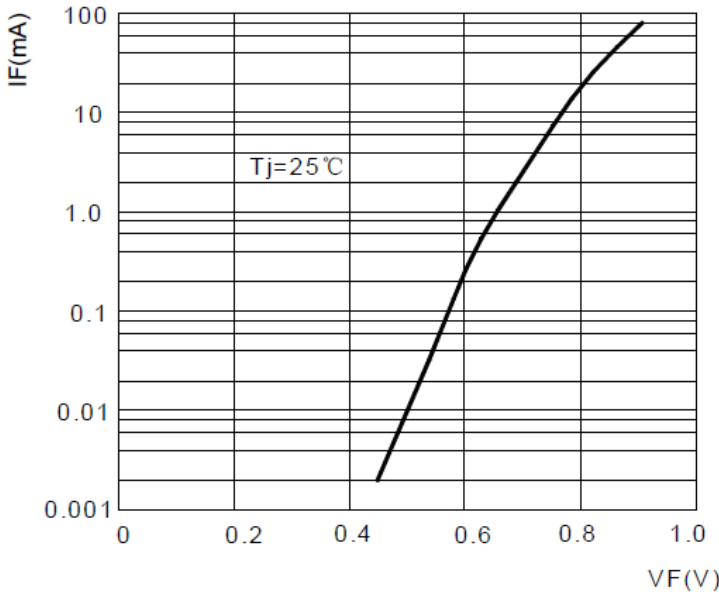

FIG6: Z-Current vs. Z-Voltage

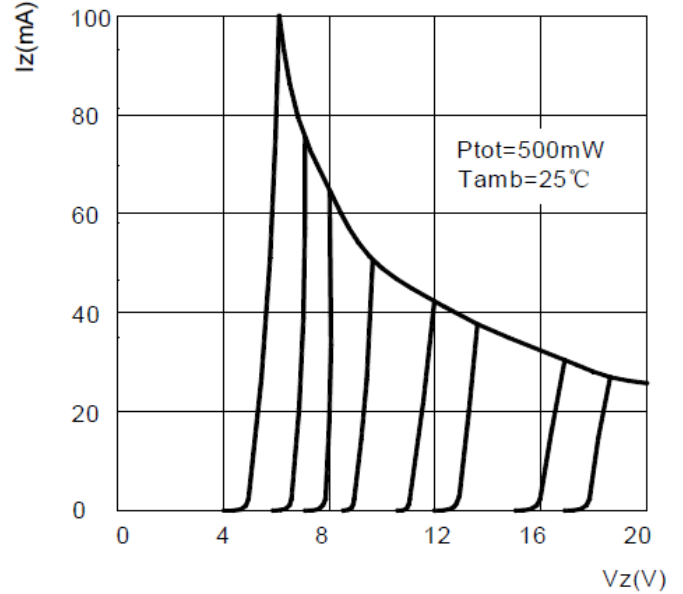

FIG7: Z-Current vs. Z-Voltage

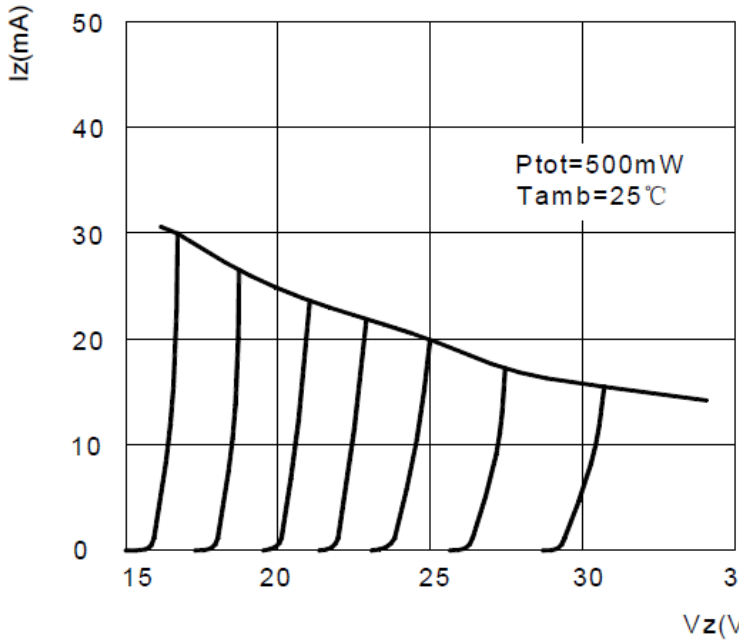
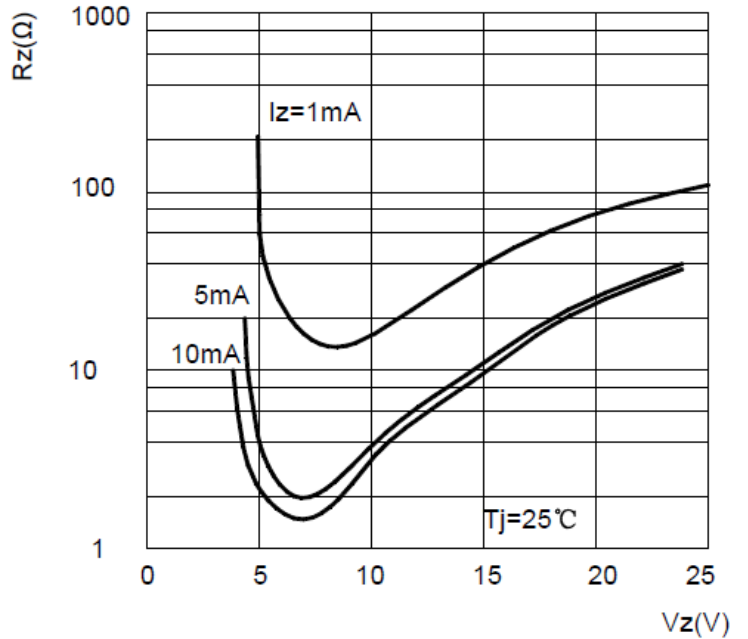

FIG8: Differential Z-Resistance vs. Z-Voltage





ZMM55 SERIES

Disclaimer

The information presented in this document is for reference only. Yangzhou Yangjie Electronic Technology Co., Ltd. reserves the right to make changes without notice for the specification of the products displayed herein to improve reliability, function or design or otherwise.

The product listed herein is designed to be used with ordinary electronic equipment or devices, and not designed to be used with equipment or devices which require high level of reliability and the malfunction of which would directly endanger human life (such as medical instruments, transportation equipment, aerospace machinery, nuclear-reactor controllers, fuel controllers and other safety devices), Yangjie or anyone on its behalf, assumes no responsibility or liability for any damages resulting from such improper use of sale.

This publication supersedes & replaces all information previously supplied. For additional information, please visit our website [http:// www.21yangjie.com](http://www.21yangjie.com) , or consult your nearest Yangjie's sales office for further assistance.