



Technical Data Sheet

Right Angle Lens Chip LEDs with Bi-Color(Multi-Color)

12-22UYSYGC/S530-A2/TR8

Features

- Package in 8mm tape on 7" diameter reel.
- Compatible with automatic placement equipment.
- Compatible with infrared and vapor phase reflow solder process.
- Multicolor type.
- Pb-free.
- The product itself will remain within RoHS compliant version.



Descriptions

- The 12-22 SMD Taping is much smaller than lead frame type components, thus enable smaller board size, higher packing density, reduced storage space and finally smaller equipment to be obtained.
- Besides, lightweight makes them ideal for miniature applications. etc.

Applications

- Automotive: backlighting in dashboard and switch.
- Telecommunication: indicator and backlighting in telephone and fax.
- Flat backlight for LCD, switch and symbol.
- General use.

Device Selection Guide

Chip			Lens Color
Type	Material	Emitted Color	
UY	AlGaInP	Brilliant Yellow	Water Clear
SYG	AlGaInP	Brilliant Yellow Green	

Package Outline Dimensions

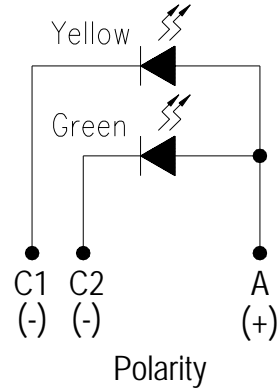
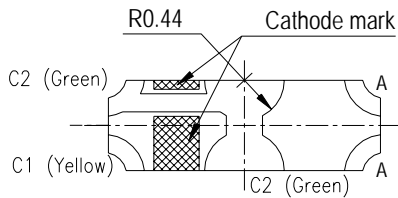
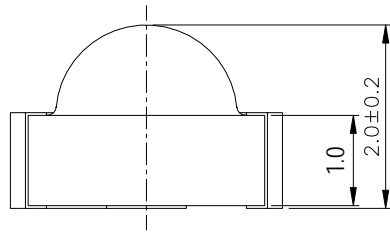
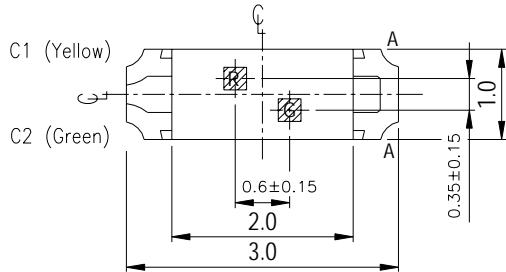

Polarity

For reflow soldering (propose)

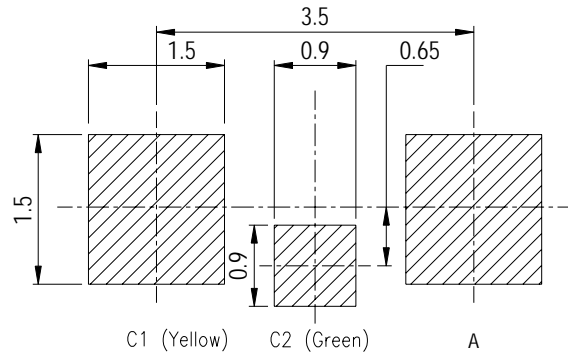

Note: The tolerances unless mentioned is $\pm 0.1\text{mm}$, Unit = mm

Absolute Maximum Ratings (Ta=25°C)

Parameter	Symbol	Rating	Unit
Reverse Voltage	V_R	5	V
Forward Current	I_F	UY:25 SYG:25	mA
Operating Temperature	T_{opr}	-40 ~ +85	°C
Storage Temperature	T_{stg}	-40~ +90	°C
Electrostatic Discharge	ESD	2000	V
Power Dissipation	P_d	UY:60 SYG:60	mW
Peak Forward Current (Duty 1/10 @1KHz)	I_{FP}	UY:60 SYG:60	mA
Soldering Temperature	T_{sol}	Reflow Soldering : 260 °C for 10 sec. Hand Soldering : 350 °C for 3 sec.	

12-22UYSYGC/S530-A2/TR8
Electro-Optical Characteristics (Ta=25°C)

Parameter	Symbol	Min.	Typ.	Max.	Unit	Condition
Luminous Intensity	UY	18	38	-----	mcd	I _F =20mA
	I _v			-----		
Viewing Angle	SYG	13	19		deg	
	2θ 1/2	-----	120	-----		
Peak Wavelength	UY		591		nm	
	λ _p	-----		-----		
Dominant Wavelength	SYG		575		nm	
	λ _d	-----	589	-----		
Spectrum Radiation Bandwidth	UY		15		nm	
	Δλ	-----		-----		
Forward Voltage	SYG		20		V	
	V _F	-----	2.0	2.4		
Reverse Current	UY		2.0	2.4		
	I _R	-----	-----	10		
					μA	V _R =5V

Typical Electro-Optical Characteristics Curves
UY

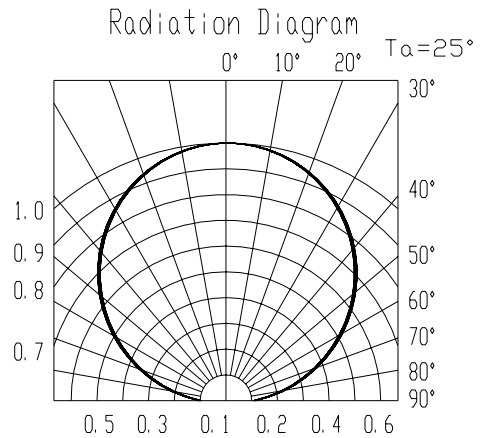
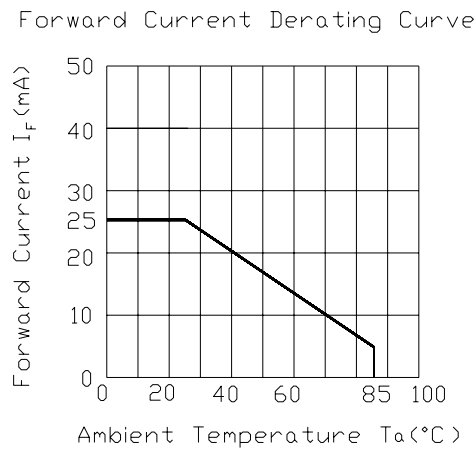
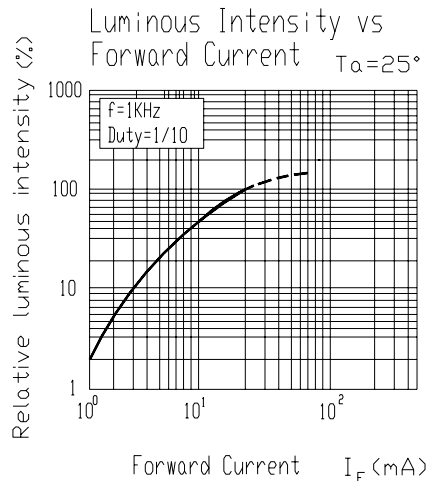
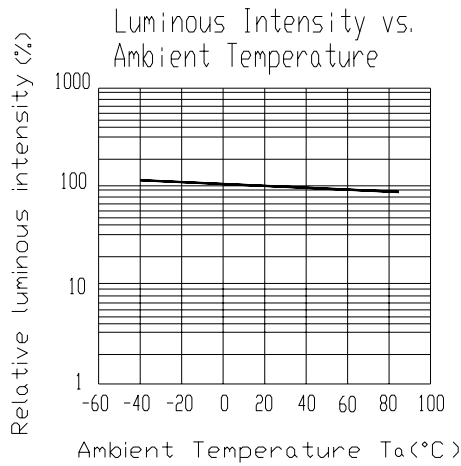
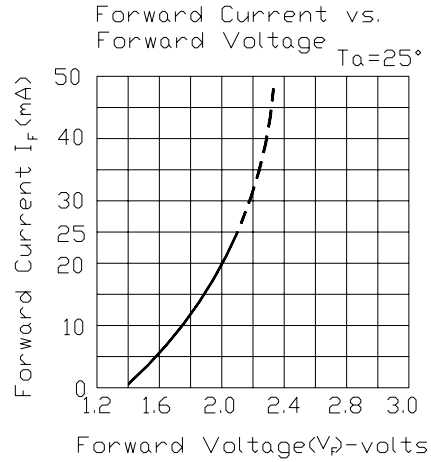
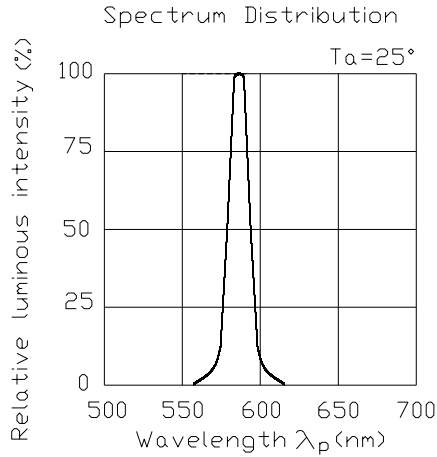

**Typical Electro-Optical Characteristics Curves
SYG**

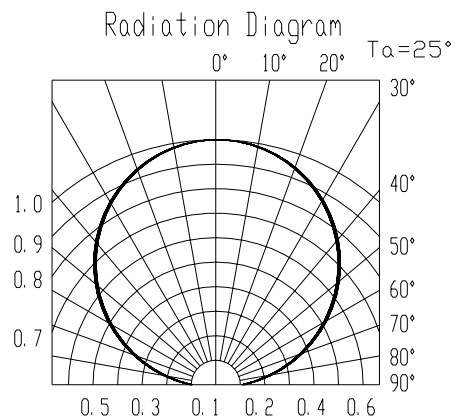
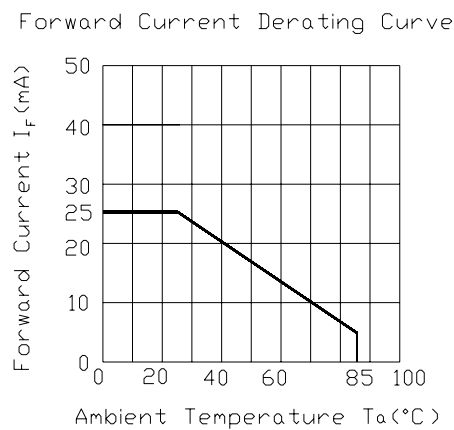
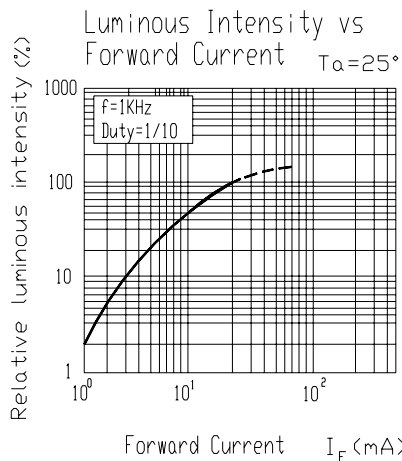
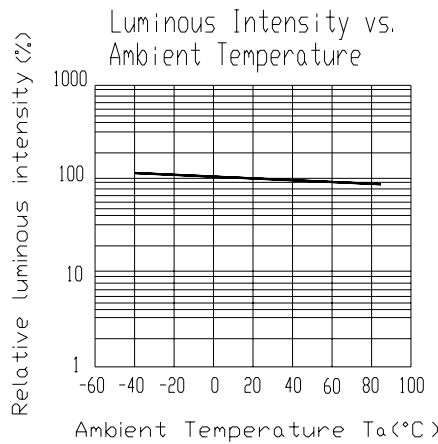
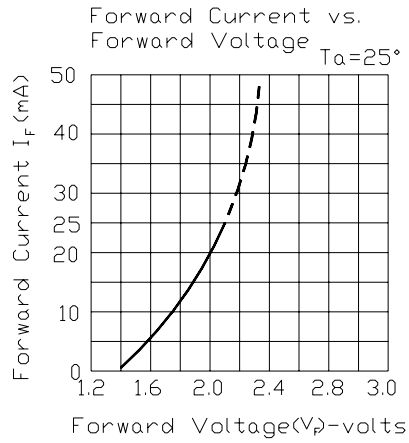
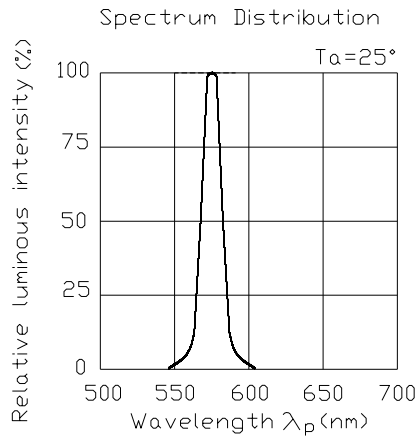

12-22UYSYGC/S530-A2/TR8

Label explanation

CAT: Luminous Intensity Rank

HUE: Dom. Wavelength Rank

REF: Forward Voltage Rank

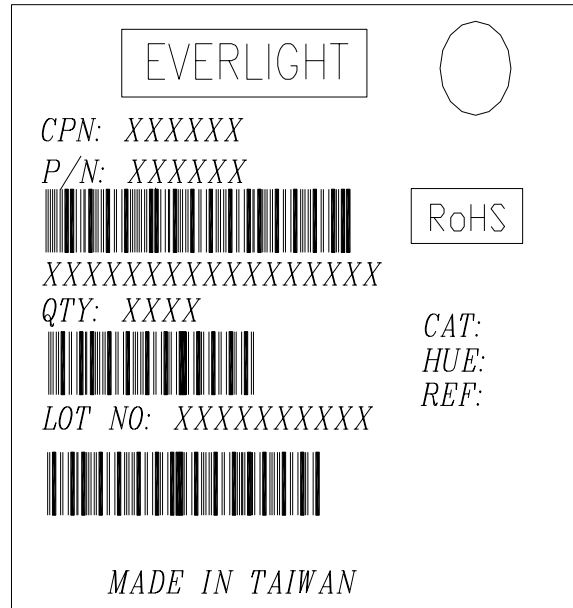

Reel Dimensions

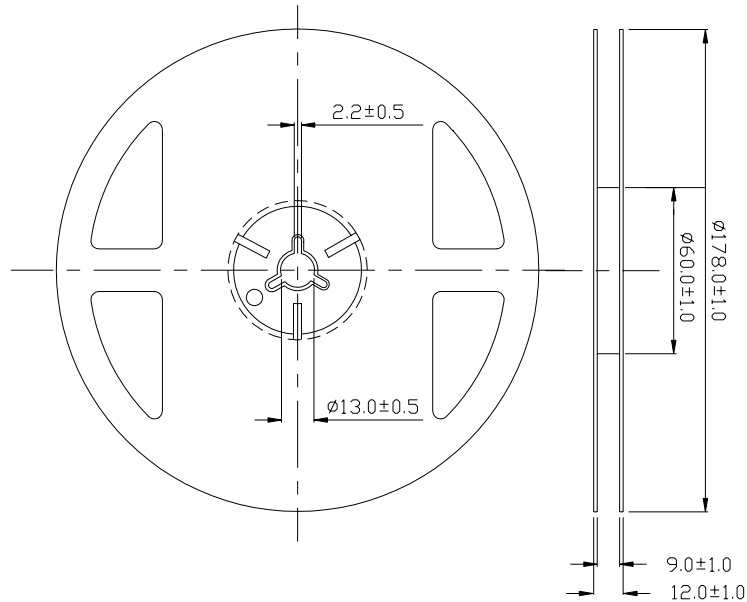

Note: The tolerances unless mentioned is ± 0.1 mm, Unit = mm

Carrier Tape Dimensions: Loaded quantity 2000 PCS per reel

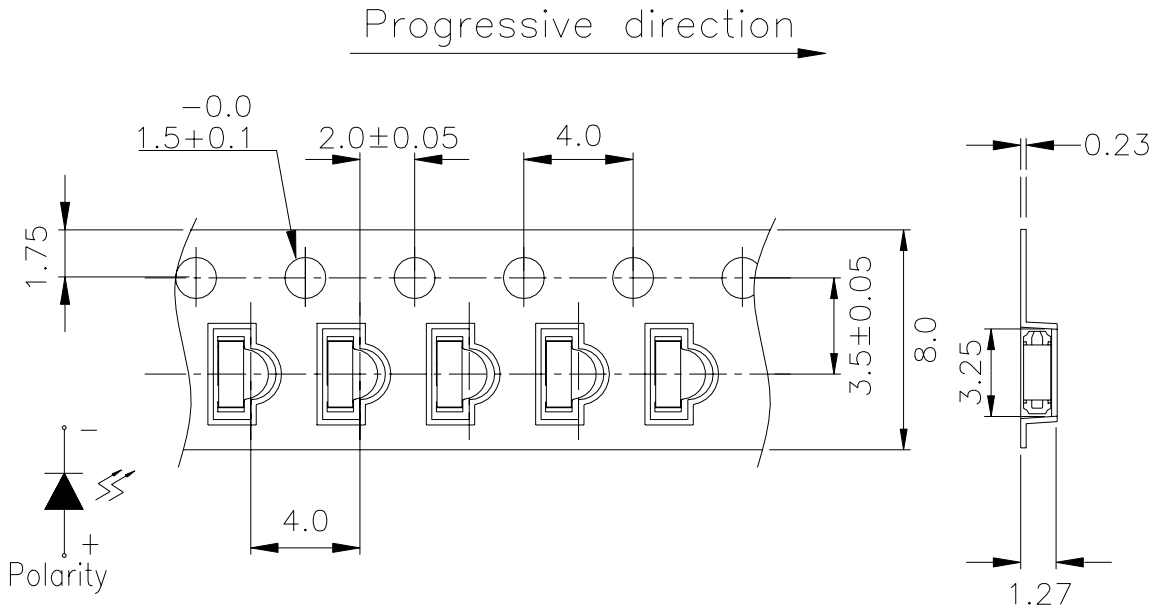

Note: The tolerances unless mentioned is ± 0.1 mm, Unit = mm

Moisture Resistant Packaging

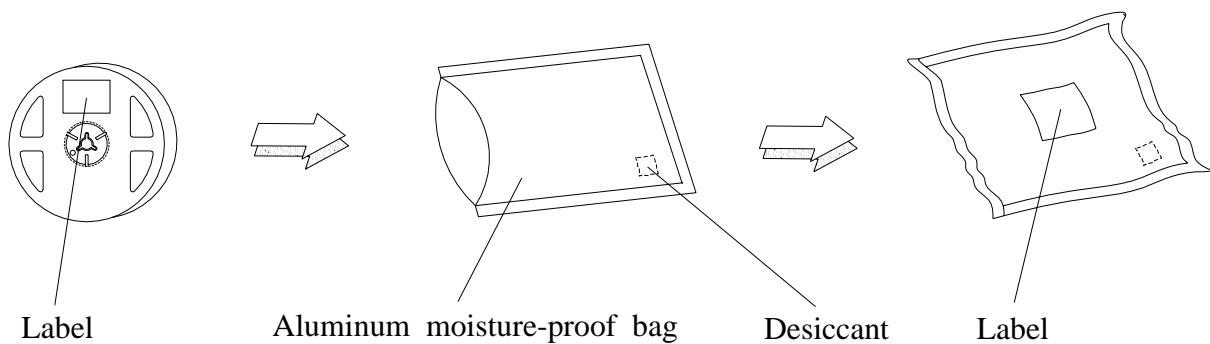

Reliability Test Items And Conditions

The reliability of products shall be satisfied with items listed below.

Confidence level : 90%

LTPD : 10%

No.	Items	Test Condition	Test Hours/Cycles	Sample Size	Ac/Re
1	Reflow Soldering	Temp. : 260°C ±5°C Min. 5sec.	6 Min.	22 PCS.	0/1
2	Temperature Cycle	H : +100°C 15min ∫ 5 min L : -40°C 15min	300 Cycles	22 PCS.	0/1
3	Thermal Shock	H : +100°C 5min ∫ 10 sec L : -10°C 5min	300 Cycles	22 PCS.	0/1
4	High Temperature Storage	Temp. : 100°C	1000 Hrs.	22 PCS.	0/1
5	Low Temperature Storage	Temp. : -40°C	1000 Hrs.	22 PCS.	0/1
6	DC Operating Life	IF = 20 mA	1000 Hrs.	22 PCS.	0/1
7	High Temperature / High Humidity	85°C / 85%RH	1000 Hrs.	22 PCS.	0/1

Precautions For Use

1. Over-current-proof

Customer must apply resistors for protection , otherwise slight voltage shift will cause big current change (Burn out will happen).

2. Storage

2.1 Do not open moisture proof bag before the products are ready to use.

2.2 Before opening the package, the LEDs should be kept at 30°C or less and 90%RH or less.

2.3 The LEDs should be used within a year.

2.4 After opening the package, the LEDs should be kept at 30°C or less and 70%RH or less.

2.5 The LEDs should be used within 168 hours (7 days) after opening the package.

2.6 If the moisture absorbent material (silica gel) has faded away or the LEDs have exceeded the storage time, baking treatment should be performed using the following conditions.

Baking treatment : 60±5°C for 24 hours.

3. Soldering Condition

3.1 Pb-free solder temperature profile

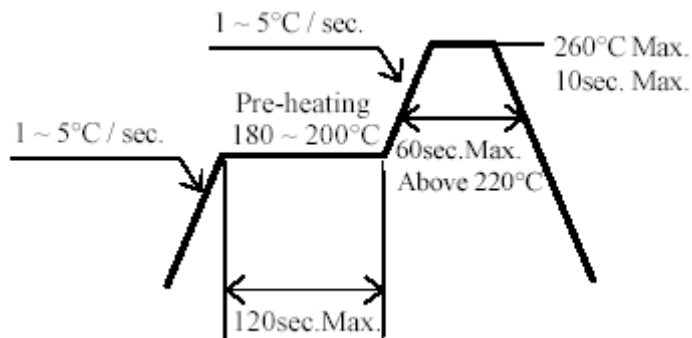

3.2 Reflow soldering should not be done more than two times.

3.3 When soldering, do not put stress on the LEDs during heating.

3.4 After soldering, do not warp the circuit board.

4.Soldering Iron

Each terminal is to go to the tip of soldering iron temperature less than 350°C for 3 seconds within once in less than the soldering iron capacity 25W. Leave two seconds and more intervals, and do soldering of each terminal. Be careful because the damage of the product is often started at the time of the hand solder.

5.Repairing

Repair should not be done after the LEDs have been soldered. When repairing is unavoidable, a double-head soldering iron should be used (as below figure). It should be confirmed beforehand whether the characteristics of the LEDs will or will not be damaged by repairing.

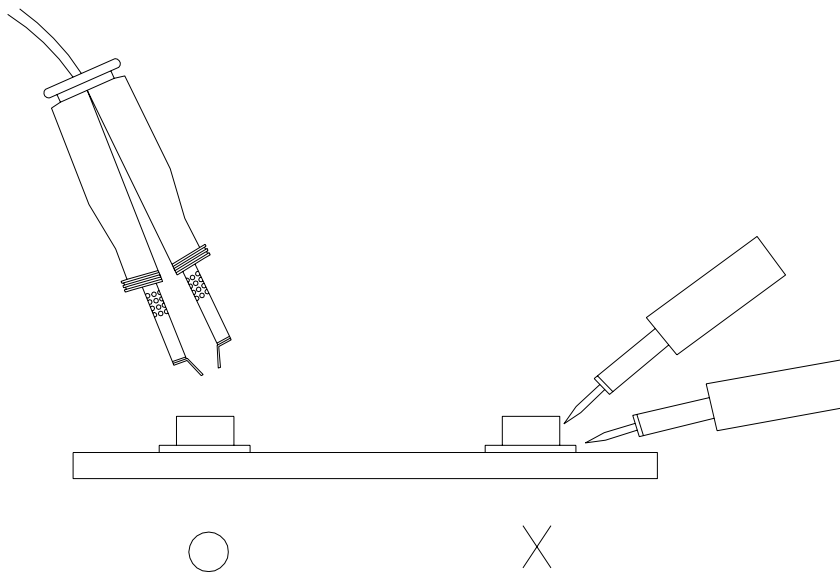

EVERLIGHT ELECTRONICS CO., LTD.

Office: No 25, Lane 76, Sec 3, Chung Yang Rd,
Tucheng, Taipei 236, Taiwan, R.O.C

Tel: 886-2-2267-2000, 2267-9936

Fax: 886-2267-6244, 2267-6189, 2267-6306

<http://www.everlight.com>