

DC Brushless Fan Motor Driver

Multifunction Single-phase Full-wave Fan Motor Driver

BD61250MUV
General Description

BD61250MUV is pre-driver IC to drive single phase H bridge output composed of external MOS FET.

The power supply input terminal and the drive output have voltage rating of 40V, so it can be used in a 24V power supply without using voltage drop down circuit.

Features

- Pre driver for external power MOS FET
- Speed controllable by PWM / DC voltage
- Minimum output duty limit
- Input / output duty slope adjustment
- Silent drive by the PWM soft switching
- Lead angle setting
- Soft start
- Standby mode
- Current limit
- Lock protection and automatic restart
- Rotation speed pulse signal(FG), Lock alarm signal(AL) selectable
- Drive PWM frequency selectable (50kHz/25kHz)

Application

- General consumer equipment of Desktop PC, Server, etc.
- Office equipment, Copier, FAX, Laser Printer, etc.

Package

VQFN024V4040

 W (Typ) x D (Typ) x H (Max)
 4.00mm x 4.00mm x 1.00mm

Absolute Maximum Ratings

Parameter	Symbol	Rating	Unit
Supply Voltage	V _{CC}	40	V
Power Dissipation	P _d	0.83 ^(Note 1)	W
Operating Temperature Range	T _{opr}	-40 to +105	°C
Storage Temperature Range	T _{str}	-55 to +150	°C
Maximum Junction Temperature	T _{jmax}	+150	°C
High Side Output Voltage	V _{OH}	V _{CC} -7 to V _{CC}	V
Low Side Output Voltage	V _{OL}	0 to 7	V
Output Current	I _{OMAX}	10	mA
Signal Output Voltage	V _{SIG}	40	V
Signal Output Current	I _{SIG}	10	mA
Reference Voltage (REF) Output Current	I _{REF}	10	mA
Input Voltage1 (PWMIN, CS, FSEL, SSEL, STBEN)	V _{IN1}	5.3	V
Input Voltage2 (HP, HM, ADC input terminal)	V _{IN2}	3.3	V

(Note 1) Derate by 6.64mW/°C when operating above Ta=25°C. (Mounted on 114.3mm × 76.2mm × 1.57mm 1layer board)

Caution 1: Operating the IC over the absolute maximum ratings may damage the IC. The damage can either be a short circuit between pins or an open circuit between pins and the internal circuitry. Therefore, it is important to consider circuit protection measures, such as adding a fuse, in case the IC is operated over the absolute maximum ratings.

Caution 2: Should by any chance the maximum junction temperature rating be exceeded the rise in temperature of the chip may result in deterioration of the properties of the chip. In case of exceeding this absolute maximum rating, design a PCB boards with power dissipation and thermal resistance taken into consideration by increasing board size and copper area so as not to exceed the maximum junction temperature rating.

Thermal Resistance^(Note 1)

Parameter	Symbol	Thermal Resistance (Typ)		Unit
		1s ^(Note 3)	2s2p ^(Note 4)	
VQFN024V4040				
Junction to Ambient	θ_{JA}	150.6	37.9	°C/W
Junction to Top Characterization Parameter ^(Note 2)	Ψ_{JT}	20	9	°C/W

(Note 1)Based on JESD51-2A(Still-Air)

(Note 2)The thermal characterization parameter to report the difference between junction temperature and the temperature at the top center of the outside surface of the component package.

(Note 3)Using a PCB board based on JESD51-3.

Layer Number of Measurement Board	Material	Board Size
Single	FR-4	114.3mm x 76.2mm x 1.57mm

Top	
Copper Pattern	Thickness
Footprints and Traces	70μm

(Note 4)Using a PCB board based on JESD51-7.

Layer Number of Measurement Board	Material	Board Size
4 Layers	FR-4	114.3mm x 76.2mm x 1.6mm

Top		2 Internal Layers		Bottom	
Copper Pattern	Thickness	Copper Pattern	Thickness	Copper Pattern	Thickness
Footprints and Traces	70μm	74.2mm x 74.2mm	35μm	74.2mm x 74.2mm	70μm

Recommended Operating Conditions

Parameter	Symbol	Min	Typ	Max	Unit
Supply Voltage	V _{CC}	4.5	12	36	V
Hall Input Voltage	V _H	0	-	2	V
PWM Input Frequency	f _{IN}	1	-	100	kHz

Input-Output Truth Table

Input			IC Output					Motor Drive Output	
HP	HM	PWM	A1H	A1L	A2H	A2L	FG	OUT1	OUT2
H	L	H	H	H	L	L	Hi-Z	L	H
L	H	H	L	L	H	H	L	H	L
H	L	L	H	H	H	L	Hi-Z	L	Hi-Z
L	H	L	H	L	H	H	L	Hi-Z	L

H; High, L; Low, Hi-Z; High impedance
SIG output is open drain output.

Pin Configuration

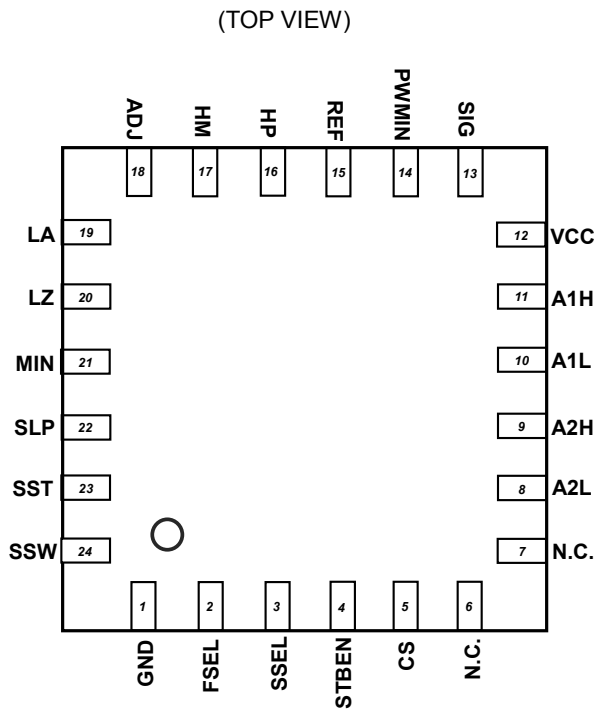

Pin Description

Pin No.	Pin Name	Function
1	GND	GND
2	FSEL	Drive PWM frequency select
3	SSEL	FG / AL signal select
4	STBEN	Standby mode enable select
5	CS	Current sensing
6	N.C.	
7	N.C.	
8	A2L	Low side output 2
9	A2H	High side output 2
10	A1L	Low side output 1
11	A1H	High side output 1
12	VCC	Power supply
13	SIG	FG / AL signal output
14	PWMIN	PWM signal input
15	REF	Reference voltage output
16	HP	Hall signal input +
17	HM	Hall signal input -
18	ADJ	Output duty correction
19	LA	Lead angle setting
20	LZ	Re-circulate angle setting
21	MIN	Minimum output duty setting
22	SLP	Input-output duty slope setting
23	SST	Soft start time setting
24	SSW	Soft switching angle setting

Block Diagram

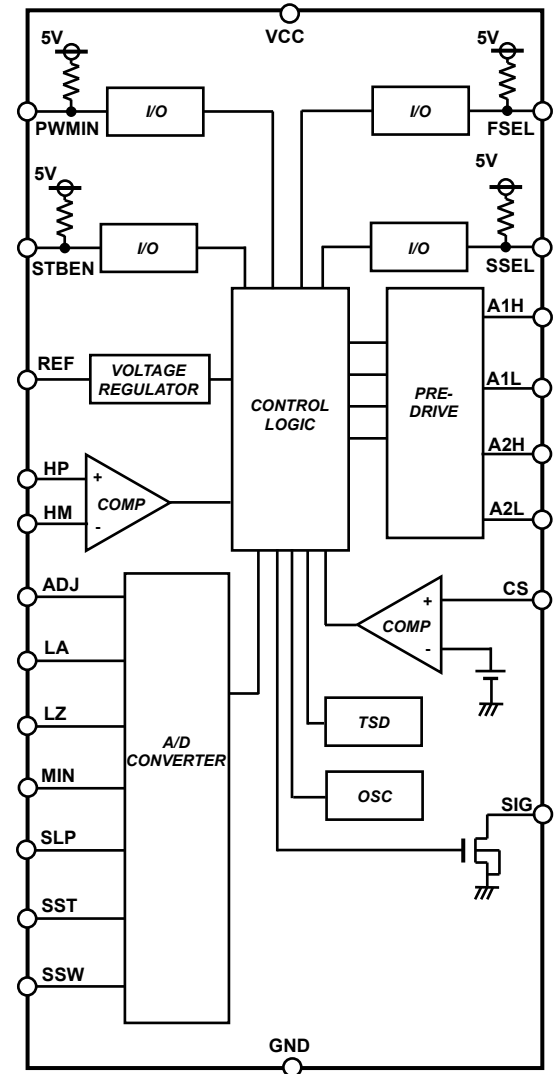

Electrical Characteristics (Unless otherwise specified Ta=25°C, V_{CC}=12V)

Parameter	Symbol	Limit			Unit	Conditions	Characteristic Data
		Min	Typ	Max			
Circuit Current	I _{CC1}	2.0	3.3	5	mA		Figure 1
Standby Current	I _{CC2}	0.1	0.3	0.5	mA		Figure 2
Hall Input Hysteresis	V _{HYS}	±5	±10	±15	mV		Figure 3
PWM Input High Level	V _{PWMH}	2	-	5.3	V		
PWM Input Low Level	V _{PWML}	-0.3	-	+0.8	V		
PWM Input Current	I _{PWMH}	-10	0	+10	μA	V _{PWM} =5V	Figure 4
	I _{PWML}	-50	-25	-12	μA	V _{PWM} =0V	Figure 5
PWM Drive Frequency 1	f _{PWM1}	35	50	65	kHz	FSEL open	
PWM Drive Frequency 2	f _{PWM2}	17.5	25	32.5	kHz	FSEL GND short	
Reference Voltage	V _{REF}	2.7	3.0	3.3	V	I _{REF} =-1mA	Figure 6, 7
Current Limit Voltage	V _{CL}	140	160	180	mV		Figure 8
High Side Output High Voltage	V _{OHH}	V _{CC} -0.6	V _{CC} -0.4	V _{CC} -0.1	V	I _O =-3mA	Figure 9
High Side Output Low Voltage	V _{OHL}	V _{CC} -5.2	V _{CC} -4.9	V _{CC} -4.6	V	I _O =+3mA	Figure 10
Low Side Output High Voltage	V _{OLH}	4.1	4.5	4.8	V	I _O =-3mA	Figure 11
Low Side Output Low Voltage	V _{OLL}	-	0.1	0.2	V	I _O =+3mA	Figure 12
FSEL Input Low Level	V _{FSELL}	-0.3	-	0.8	V	FSEL=OPEN: f _{PWM} =50kHz FSEL=GND: f _{PWM} =25kHz	
SSEL Input Low Level	V _{SSELL}	-0.3	-	0.8	V	SSEL=OPEN:SIG=FG SSEL=GND:SIG=AL	
STBEN Input Low Level	V _{STBL}	-0.3	-	0.8	V	STBEN=OPEN : Standby function enable STBEN=GND : Standby function disable	
SIG Output Low Voltage	V _{SIGL}	-	-	0.3	V	I _{sig} =+5mA	Figure 13
SIG Output Leak Current	I _{SIGL}	-	-	10	μA	V _{sig} =40V	Figure 14
Lock Protection ON Time	t _{ON}	0.2	0.3	0.4	s		Figure 15
Lock Protection OFF Time	t _{OFF}	4	6	8	s		Figure 16

About a current item, define the inflow current to IC as a positive notation.

Typical Performance Curves (Reference Data)

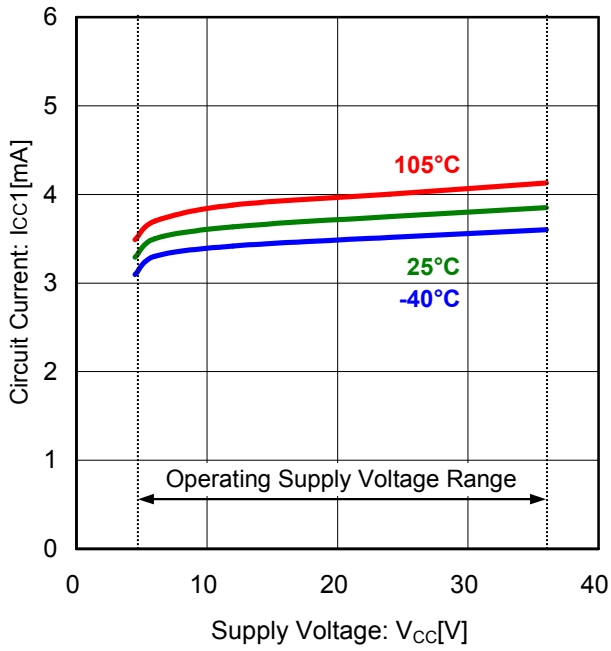

Figure 1. Circuit Current vs Supply Voltage

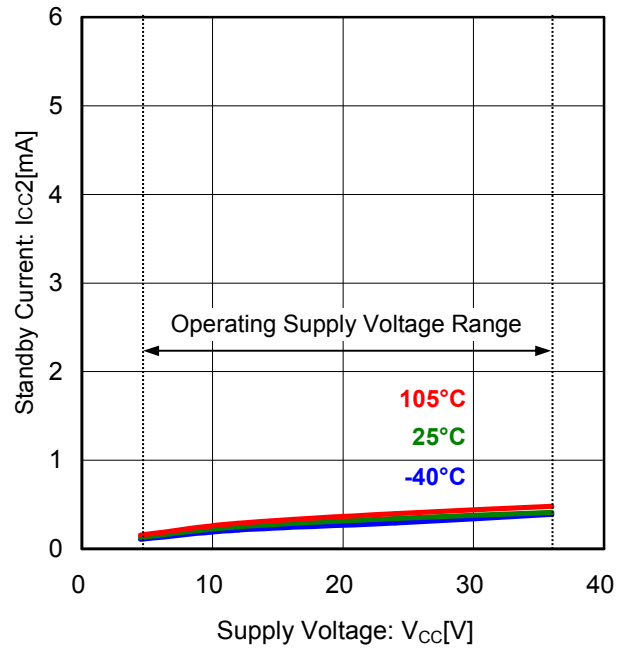

Figure 2. Standby Current vs Supply Voltage

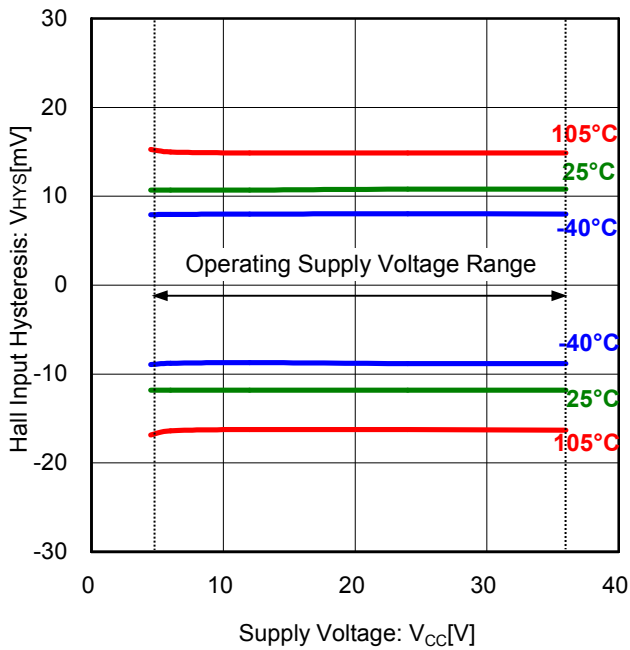

Figure 3. Hall Input Hysteresis vs Supply Voltage

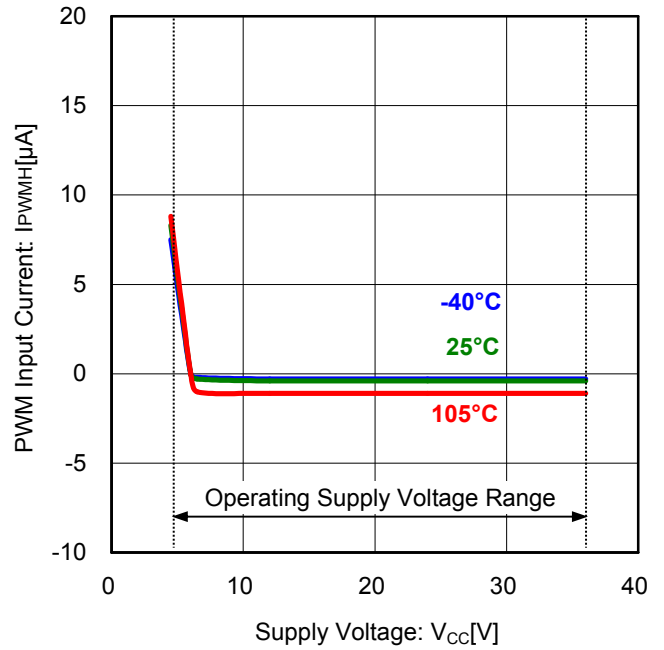

Figure 4. PWM Input Current vs Supply Voltage (V_{PWM}=5V)

Typical Performance Curves (Reference Data) – continued

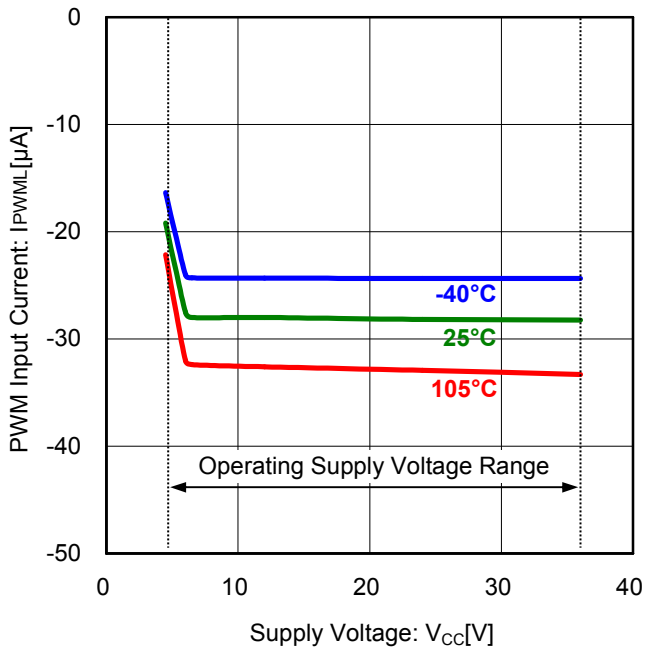

Figure 5. PWM Input Current vs Supply Voltage ($V_{PWM}=0V$)

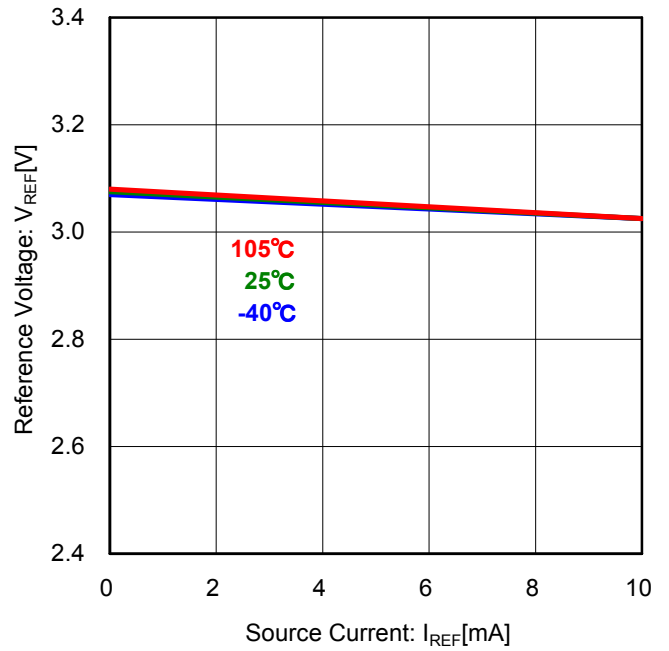

Figure 6. Reference Voltage vs Source Current ($V_{CC}=12V$)

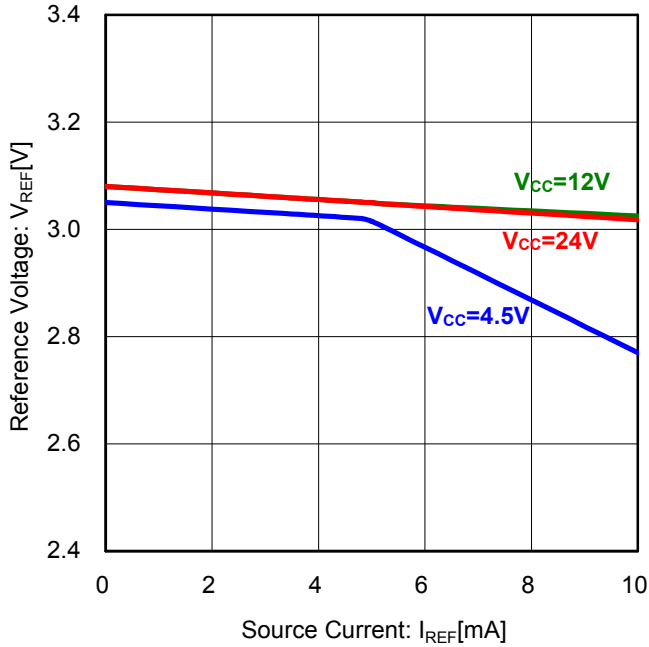

Figure 7. Reference Voltage vs Source Current ($T_a=25^\circ C$)

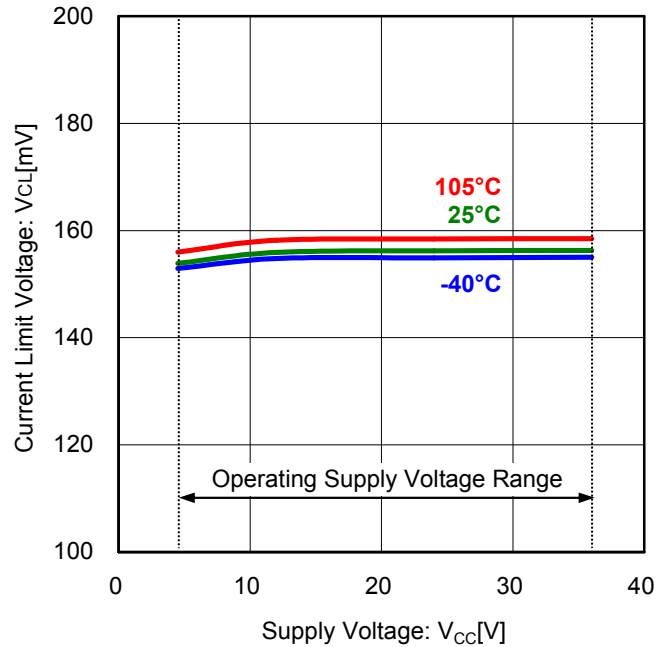

Figure 8. Current Limit Voltage vs Supply Voltage

Typical Performance Curves (Reference Data) – continued

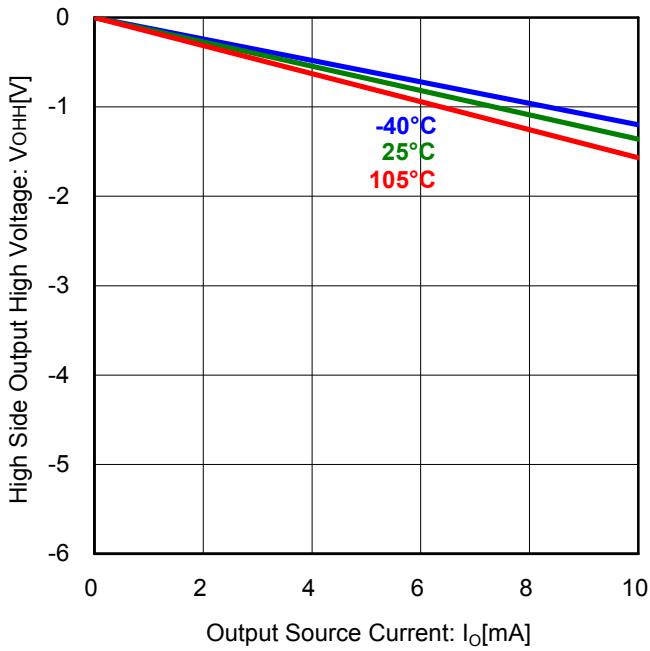

Figure 9. High Side Output High Voltage vs Source Current (V_{CC}=12V, differential voltage to V_{CC})

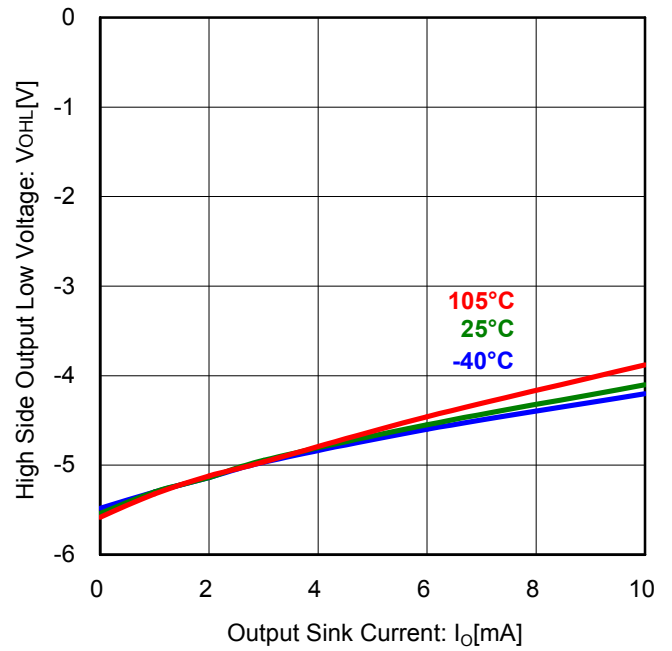

Figure 10. High Side Output Low Voltage vs Sink Current (V_{CC}=12V, differential voltage to V_{CC})

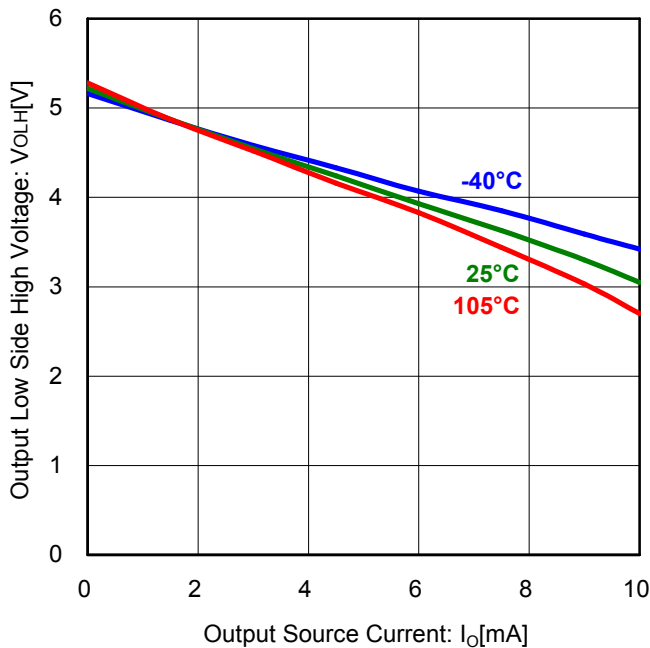

Figure 11. Low Side Output High Voltage vs Source Current (V_{CC}=12V)

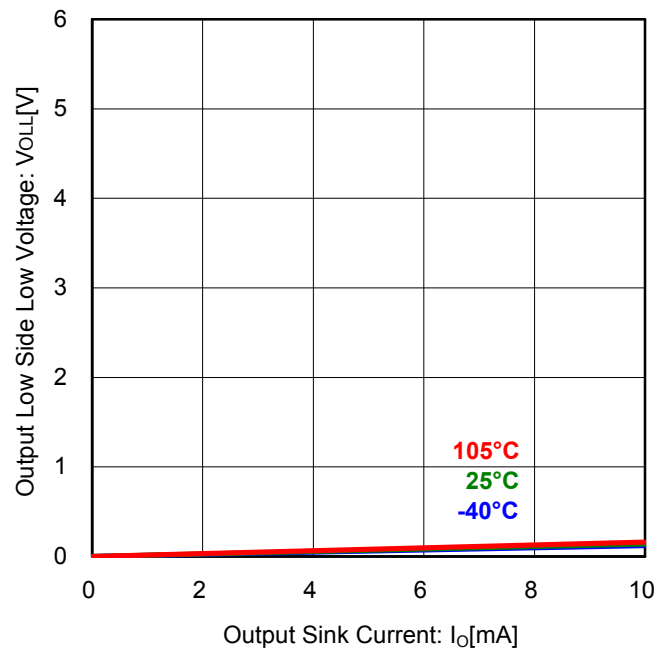

Figure 12. Low Side Output Low Voltage vs Sink Current (V_{CC}=12V)

Typical Performance Curves (Reference Data) – continued

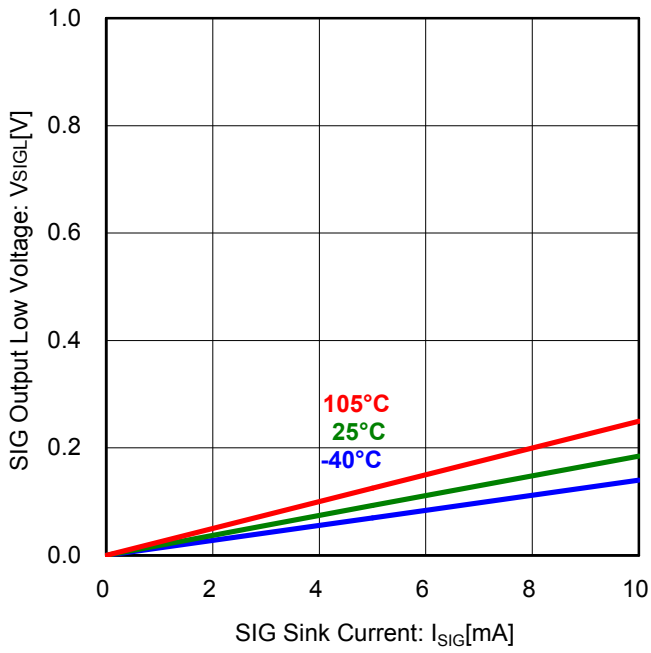

Figure 13. SIG Output Low Voltage vs Sink Current

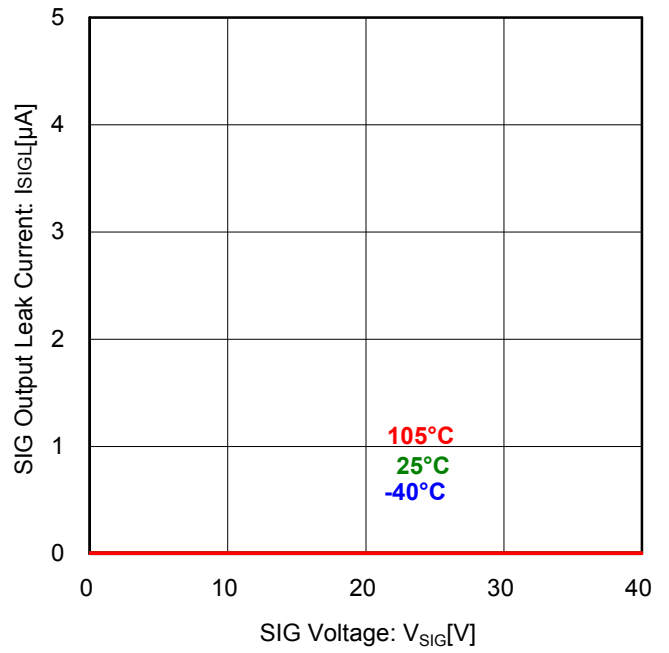

Figure 14. SIG Output Leak Current vs SIG Voltage

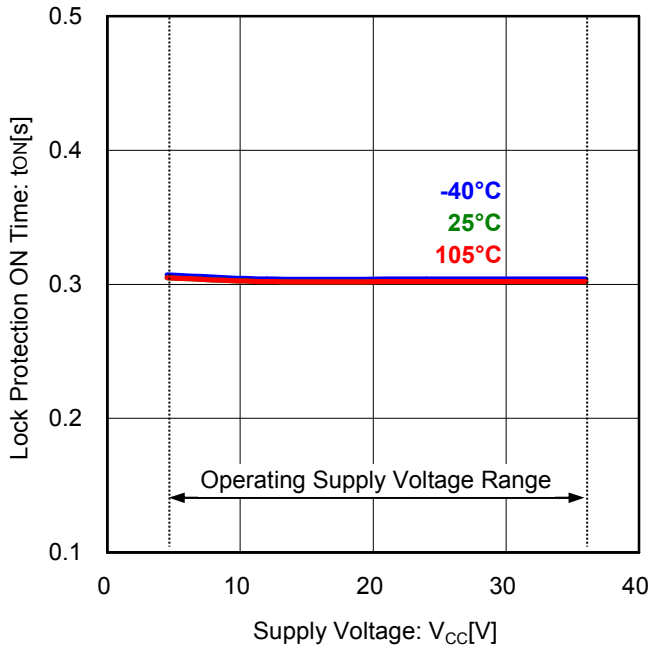

Figure 15. Lock Protection ON Time vs Supply Voltage

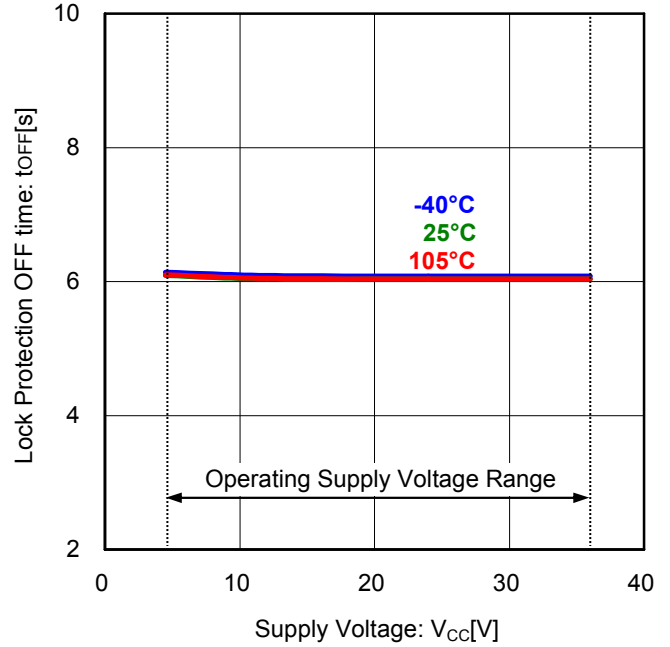
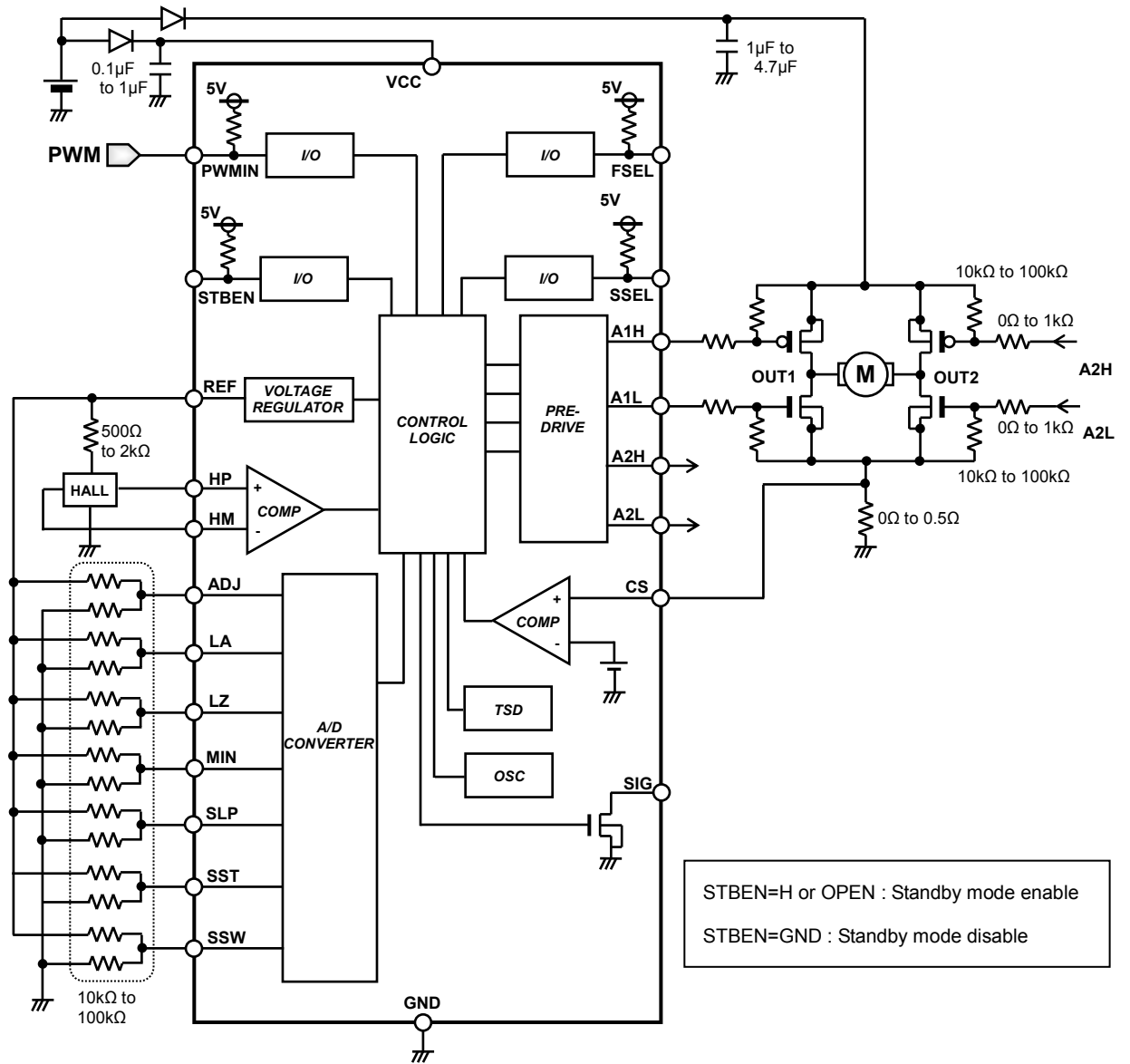

Figure 16. Lock Protection OFF Time vs Supply Voltage

Application circuit Reference

1. Direct PWM Control

This is the application example of direct PWM input into PWM terminal. Minimum rotational speed is set in MIN terminal voltage.



When a function is not used, do not let the A/D converter input terminal open.

Resistor Divider

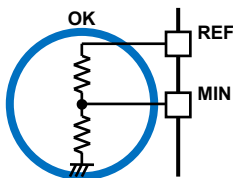

Resistor Pull-down

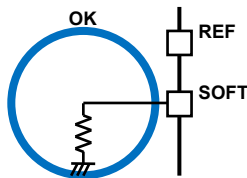

Resistor Pull-up

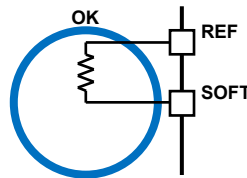

Terminal Open (Prohibited input)

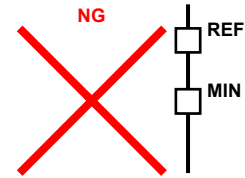

2. DC Voltage Control

This is the application example of DC voltage into MIN terminal. Minimum rotational speed setting is disable.

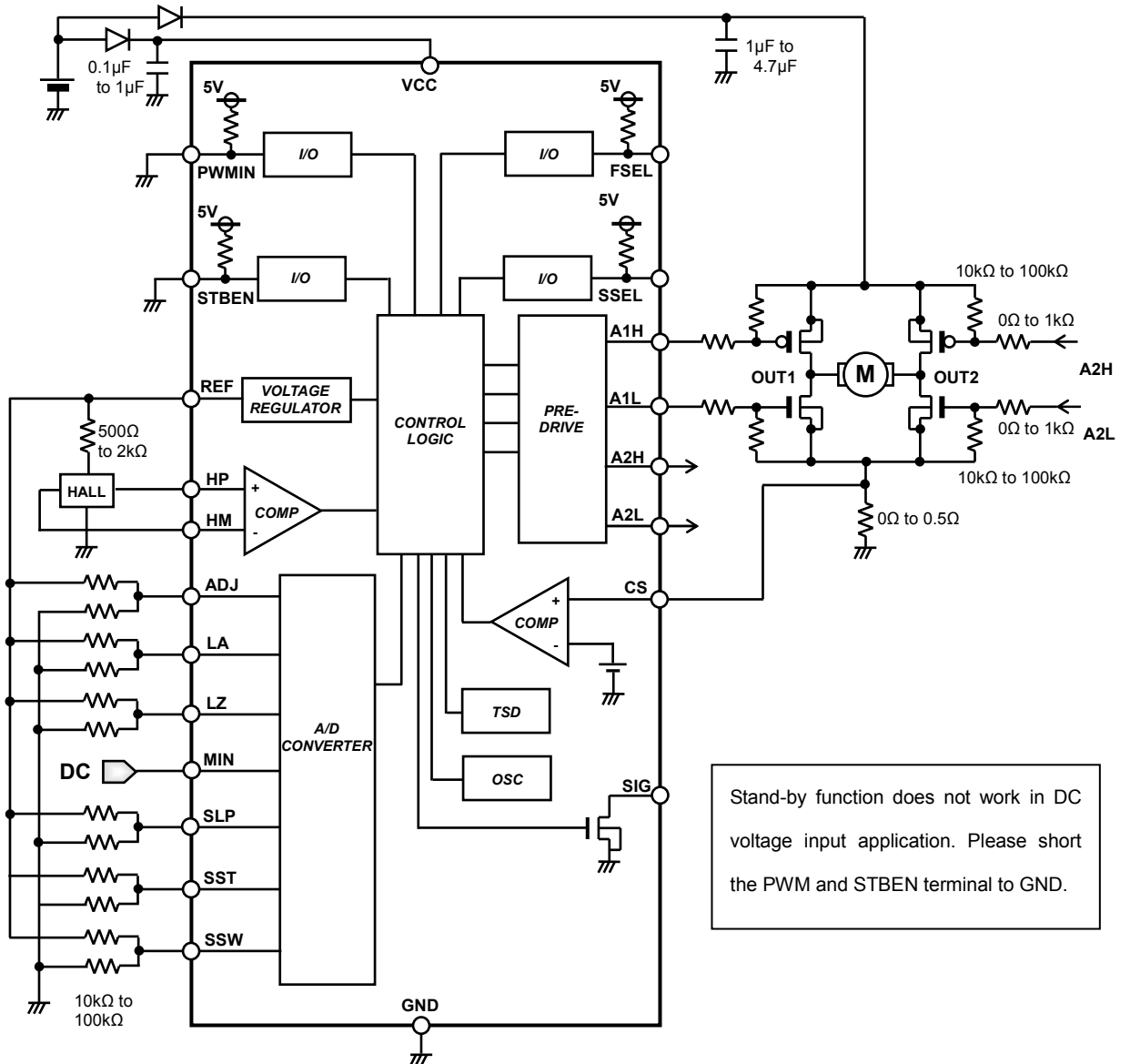

When a function is not used, do not let the A/D converter input terminal open.

Resistor Divider

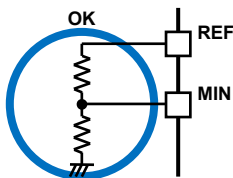

Resistor Pull-down

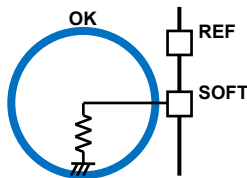

Resistor Pull-up

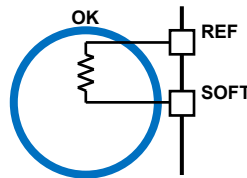

Terminal Open (Prohibited input)

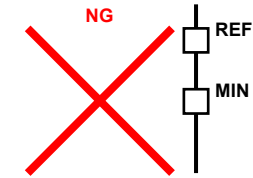

Functional Descriptions

1. Speed Control

There are 2 ways to control the speed of motor.

- (1) PWM Control (Input PWM pulse into PWM terminal)
- (2) Voltage Control (Input DC voltage into MIN terminal)

The resolution of (1) input duty, (2) input voltage are 8bit (256steps) both. Output PWM resolution is 8bit, output PWM frequency is 50kHz (FSEL=open) or 25kHz (FSEL=GND). When computed duty is less than 2.3%, a driving signal is not output.

(1) PWM Control

Output PWM duty is changed depending on input PWM duty from PWMIN terminal, and rotational speed is controlled. Please refer to input voltage 1(P.1) and recommended operating conditions (P.2) for the signal input condition from a PWMIN terminal. In the case of PWMIN terminal is open, internal voltage (about 5V) is applied to PWMIN terminal, and output is driven in 100%. Because the PWM signal is filtered inside the IC and its signal is processed, the PWM frequency of the drive output is not same to the input PWM frequency.

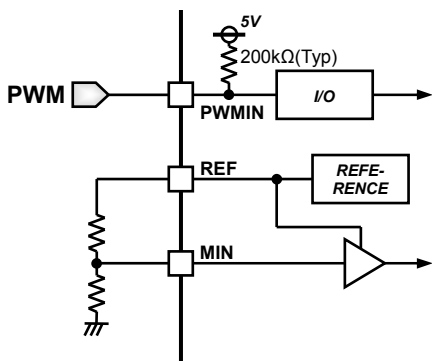

Figure 17. PWM input and minimum output duty setting

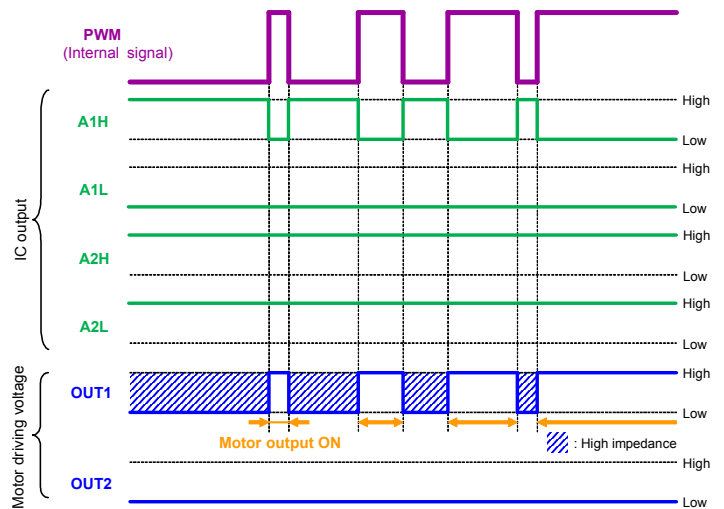

Figure 18. Output PWM operation timing chart

Minimum Output Duty Setting (MIN)

The voltage which divided REF terminal voltage by resistance like Figure 17 is input into MIN terminal, and minimum output duty is set. When input duty from a PWM terminal is lower than minimum output duty which is set by MIN terminal, the output duty does not fall to lower than minimum output duty.

The MIN terminal is the input terminal of the analog-digital converter to have an input voltage range of the REF voltage, and the resolution is 256 steps (0.39% per step). When minimum output duty is not set, please perform resistance pull-down of MIN terminal.

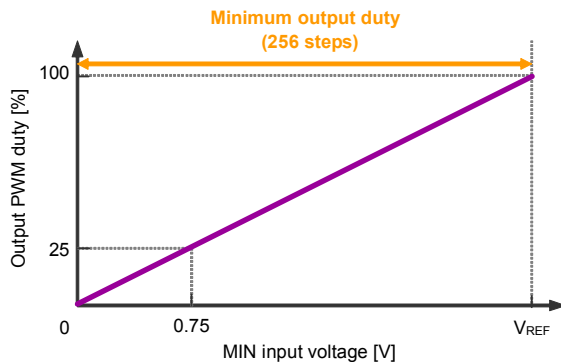

Figure 19. Relation of MIN input voltage and output duty

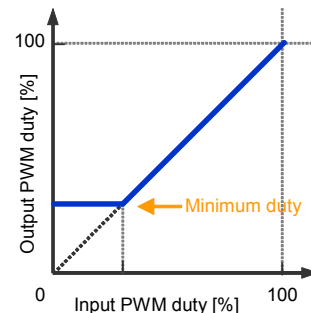

Figure 20. Relation of input and output duty when minimum duty is set

(2) Voltage Control

Output duty is controlled by input voltage from MIN terminal. Output duty is 100% when MIN terminal voltage is 3V (Typ), output duty is 0% when MIN terminal voltage is 0V. (If using SLOP function, it is not like this.)

In voltage control mode, short the PWMIN terminal and STBEN terminal to GND. Standby function is disabled.

*In voltage control mode, the voltage of MIN terminal is read with AD converter, and output duty is decided. AD converter is off in standby mode, so AD converter cannot read the input voltage. Please set the standby function disable in voltage control.

Please refer to input voltage 2(P.1) for the input condition of the MIN terminal. Because terminal voltage becomes unsettled when MIN terminal is in an open state, like application of Figure 21, please be applied some voltage to MIN terminal. Minimum output duty cannot be set in voltage control.

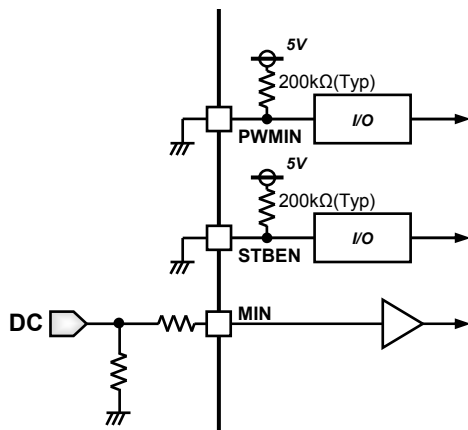

Figure 21. Voltage speed control application

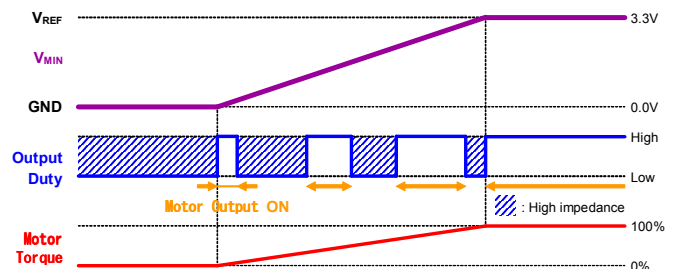

Figure 22. Operation of MIN terminal input

*In voltage control mode

- Minimum output duty cannot be set
- Standby function doesn't work

2. Input-output Duty Slope Setting (SLP)

Slope properties of input duty and output duty can be set with SLP terminal like Figure 23. SLP setting work in both mode, PWM control and voltage control. The resolution is 7bit (128 steps).

The voltage of SLP terminal is less than 0.325V (Typ), slope of input-output duty characteristic is fixed to 1. And fixed to 0.5 in 0.325V to 0.75V (Typ) (refer to Figure 24). When slope setting is not set, pull-down SLP terminal.

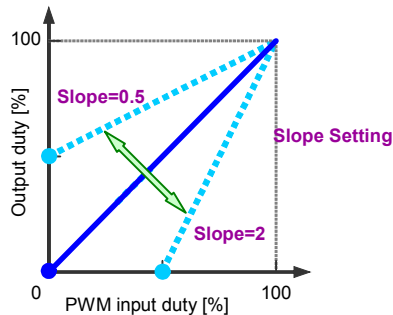

Figure 23. Properties of input-output duty slope setting

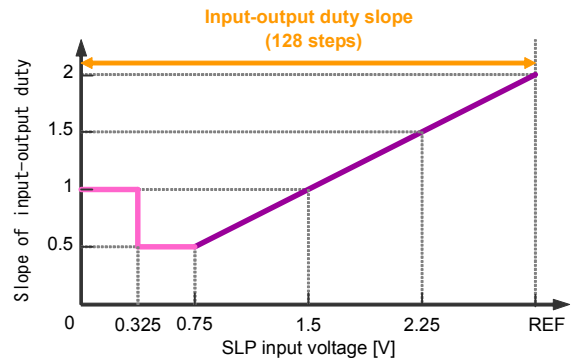

Figure 24. Relations of SLP terminal voltage and the input-output duty slope characteristics

3. Input and Output Duty Properties Adjustment Function (ADJ)

When input duty vs output duty shows the characteristic of the straight line, rotational speed may become the characteristics that middle duty area swells by the characteristic of fan motor. (Figure 25)

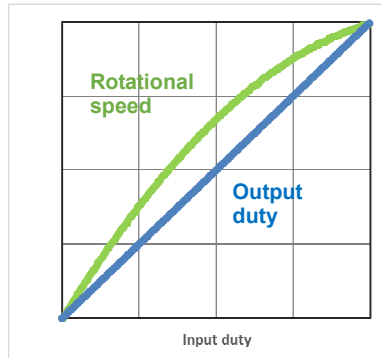

Figure 25. Properties curve of input PWM duty vs rotational speed

This IC reduces duty in the middle duty area and can adjust rotational speed characteristics of the motor with a straight line.

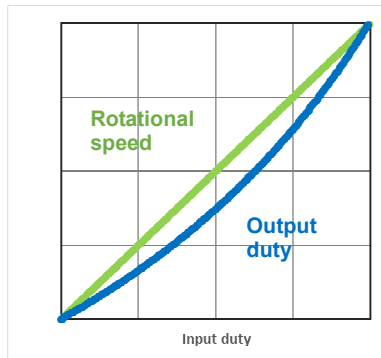

Figure 26. Properties curve of input PWM duty vs rotational speed after adjusting

The adjustment to reduce duty is performed by ADJ terminal input voltage. The ADJ terminal is input terminal of A/D converter and the resolution is 8bit. By input 0 of the ADJ terminal, the characteristic of input duty vs. output duty becomes straight line (no adjustment). The adjustment become maximum by input 256(max), and output duty in input duty 50% decreases to about 25%.

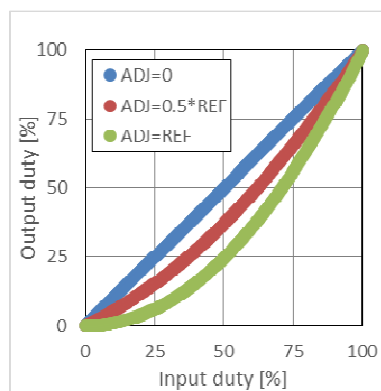

Figure 27. Input duty vs output duty characteristics

Please set the voltage of ADJ terminal so that motor rotation speed in input duty 50% is on the diagonal which links the rotation speed of 0% to 100%. IC corrects output duty so that overall rotation speed properties match a straight line.

When it is used together with SLP function, at first ADJ adjustment is performed in slope=1, and please adjust SLP after adjusting input duty vs. rotation speed property.

4. Soft Switching and Regenerative Angle Setting

(1) Soft switching angle setting (SSW)

Angle of the soft switching can be set by the input voltage of SSW terminal. When one period of the hall signal is assumed 360°, the angle of the soft switching can be set from 0° to 90° by the input voltage of SSW terminal (refer to Figure 28). Resolution of SSW terminal is 128 steps. Operational image is shown in Figure 29.

*Soft switching angle means the section where output duty changes between 0% and setting duty at the timing of output phase change. To smooth off the current waveform, the coefficient table that duty gradually changes is set inside IC, and the step is 16.

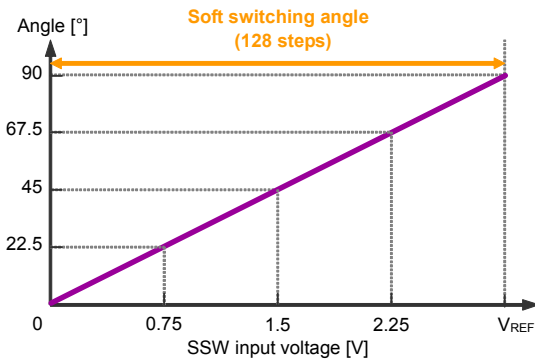

Figure 28. Relations of SSW terminal voltage and the angle of soft switching

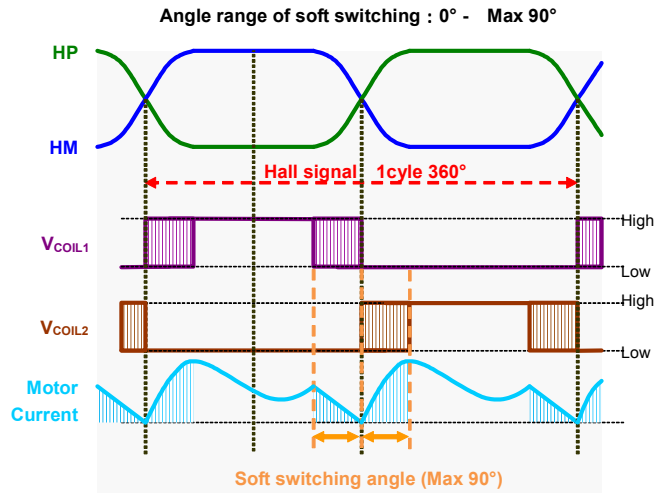

Figure 29. Soft switching angle

(2) Re-circulate Angle Setting (LZ)

Re-circulate angle at the timing of output phase changes can be set by the input voltage of LZ terminal. When one period of the hall signal is assumed 360°, the angle of the re-circulate can be set from 0° to 90° by the input voltage of LZ terminal (refer to Figure 30). Resolution of LZ terminal is 128steps. Operational image is shown in Figure 31.

*Re-circulate angle means the section where the coil current re-circulate before the timing of output phase change. If it is set appropriately, it is effective to suppress leaping up of voltage by BEMF, and reduce invalid electricity consumption. The logic of the output transistor in the section is decided depending on the hall input logic. As for the output of the H logic, the logic of the motor output in high impedance (Hi-Z). The output of the L logic remains L.

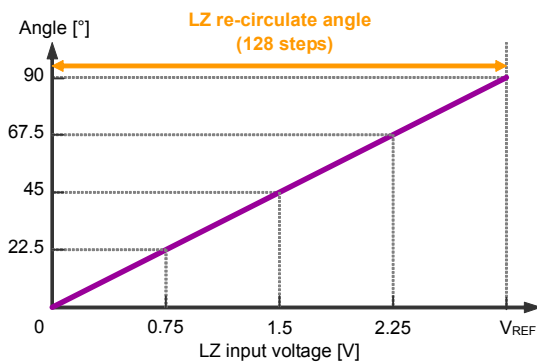

Figure 30. Relations of LZ terminal voltage and the angle of re-circulate

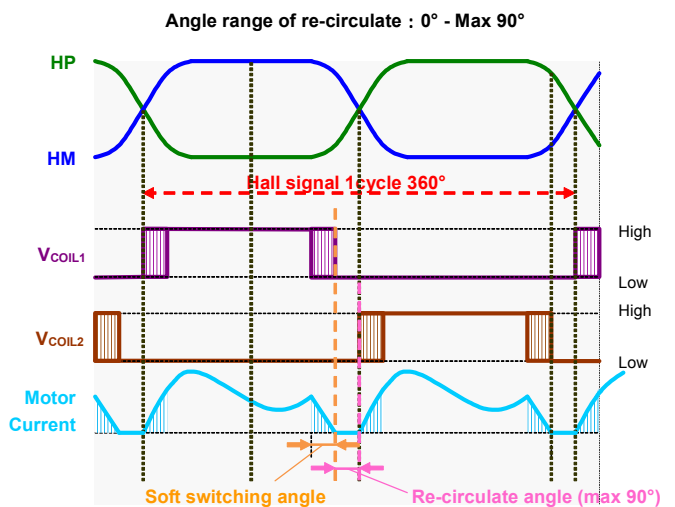

Figure 31. Re-circulate angle

5. Lead Angle Setting (LA)

Angle of lead/delay of the output phase change timing to the hall signal can be adjusted. When one period of the hall signal is assumed 360°, lead/delay angle can be set from 0° to 22.5° by LA terminal voltage (refer to Figure 32). Resolution of LA terminal is 64steps (0.7° per step). Operational image is shown in Figure 33.

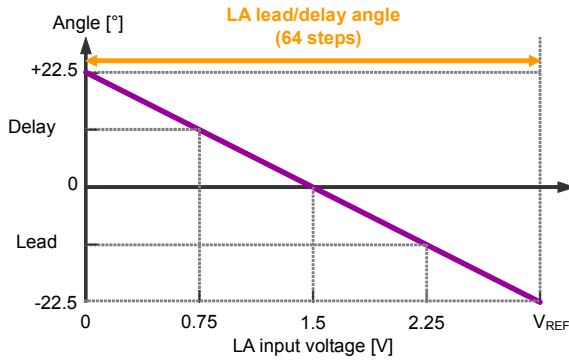

Figure 32. Relations of LA terminal voltage and lead/delay angle

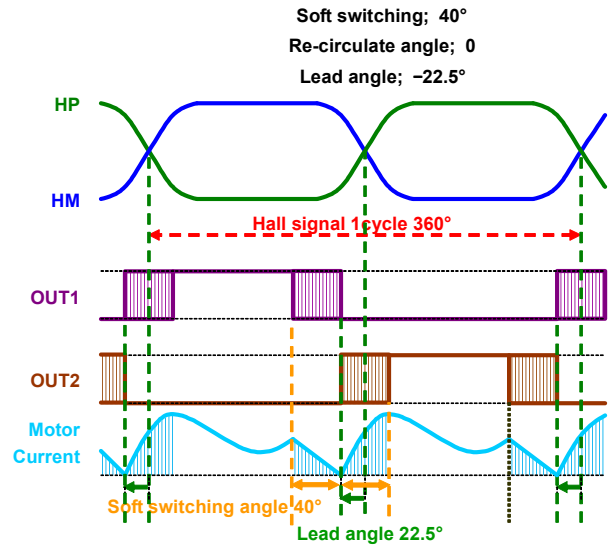

Figure 33. Lead angle operation

LA setting decide the point of output changing timing, PWM soft switching and LZ re-circulate angle are decided based on that point. When PWM soft switching, re-circulate, lead angle setting are changed each, operational example image is show in Figure 34.

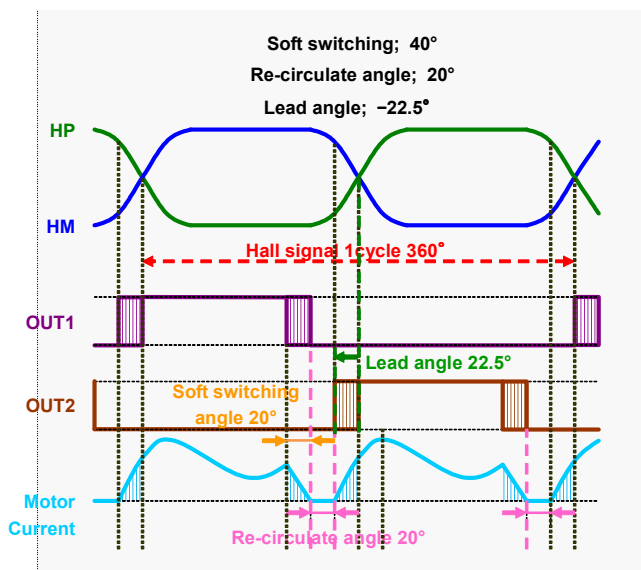

Figure 34. Motor operation waveform when each setting are applied

6. Soft Start

Soft start function gradually change drive duty to suppress sound noise and peak current when the motor start up etc. PWM duty resolution is 8bit (256steps, 0.39% per step). SST terminal sets the step up time of duty increment.

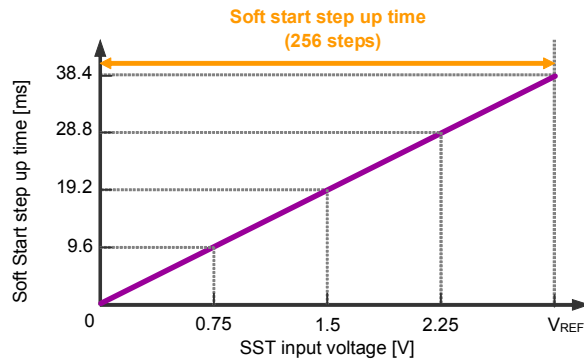

Figure 35. Relations of SST terminal voltage and soft start step up time

Duty transition time is

$$(\text{Difference of current duty and Target duty (output duty after SLP/ADJ calculation)}) \times (\text{step time})$$

When soft start time is set for a long time, lock protection may be detected without enough motor torque when motor start up from 0% duty. Therefore start up duty is set to approximately 20% (50/256).

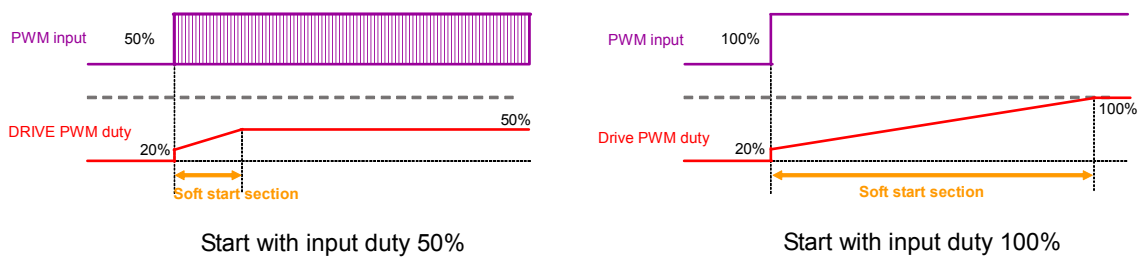

Figure 36. Soft start operation image from motor stop condition

When SST terminal voltage = REF terminal voltage, and 100% duty is input on motor stop condition, output duty arrives at 100% after progress the time of $38.4\text{ms} \times (256-50\text{step}) = 7.91$ seconds

Soft start functions always work when the change of input duty as well as motor start up. In addition, it works when duty goes down from high duty. Duty step down time is the half of duty step up time.

7. Start duty assist

It is the function that enable the motor to start even if drive duty output is low, when the soft start function is not used. When input duty is within 50% at motor stop condition, 50% duty is output till four times of hall signal change are detected. Operational image is shown in Figure 37.

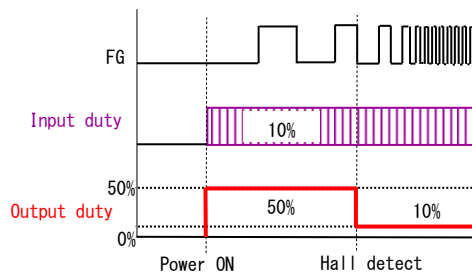

Figure 37. Start duty assist operation at input duty 10%

8. Standby Function (only for PWM control application)

When PWMIN terminal input duty is less than 1.5% (input PWM frequency 25kHz), IC shut off the circuit to reduce current consumption in motor stop state. Because circuit current of IC oneself is cut with the standby mode, and the voltage output of the REF terminal stops, the power consumption that a hall device uses and the power consumption to use by resistance for the input setting of the analog-digital converter can be reduced.

Standby function is effective in STBEN = open, and can invalidate standby function in STBEN = GND short.

This IC processes input duty from PWMIN terminal through the filter in logic circuit. Therefore the time to shift standby mode varies according to input PWM duty before inputting PWM=L. When PWM=L is input, relations of the input duty till then and the time to detect 0% are shown in Figure 39.

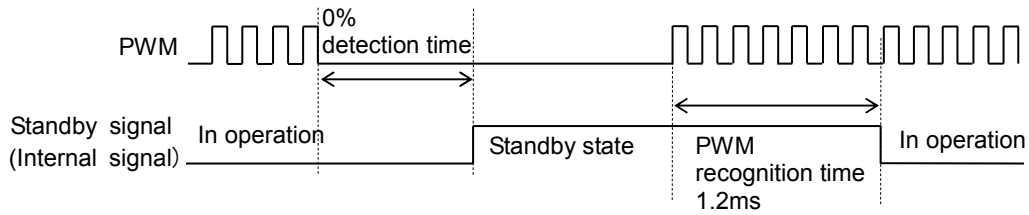

Figure 38. Standby detection time and recover time

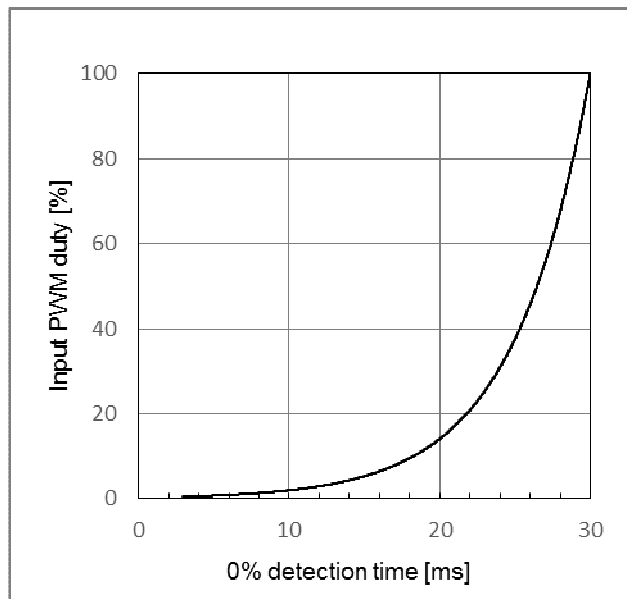
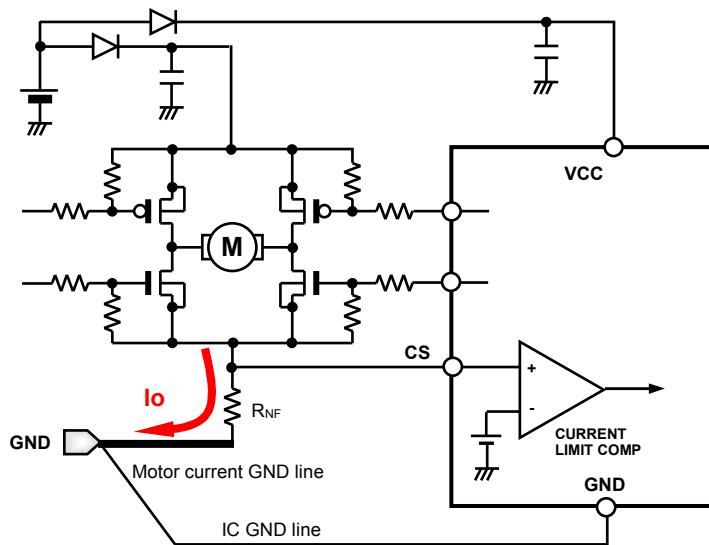

Figure 39. Input PWM DUTY vs 0% detection time

*When the soft start time is set, it takes more time to duty fall down except the filter time of Figure 39.

9. Current Limit

Current limit function turns off the output when the current flow through the motor coil is detected exceeding a set value. The working current value of the limit is determined by current limit voltage V_{CL} and CS terminal voltage. In Figure 40, current flow in motor coil is I_o , resistor to detect I_o is R_{NF} , power consumption of R_{NF} is P_R , current limit voltage $V_{CL}=160\text{mV}$ (Typ), current limit value and power consumption of R_{NF} can be calculated below expression. When current limit function is not used, please short CS terminal to GND.



$$I_o[A] = V_{CL}[V] / R_{NF}[\Omega]$$

$$= 160[\text{mV}] / 0.1[\Omega]$$

$$= 1.6[A]$$

$$P_R[W] = V_{CL}[V] \times I_o[A]$$

$$= 160[\text{mV}] \times 1.6[A]$$

$$= 0.256[W]$$

Figure 40. Current limit setting and GND line

10. Lock Protection and Automatic Restart

Motor rotation is detected by hall signal period. IC detects motor rotation is stop when the period becomes longer than the time set up at the internal counter, and IC turns off the output. Lock detection ON time (t_{ON}) and lock detection OFF time (t_{OFF}) are set by the digital counter based on internal oscillator. Therefore the ratio of ON/OFF time is always constant. Timing chart is shown in Figure 41. AL signal is output in SSEL terminal = GND, and FG signal is output in SSEL terminal = open.

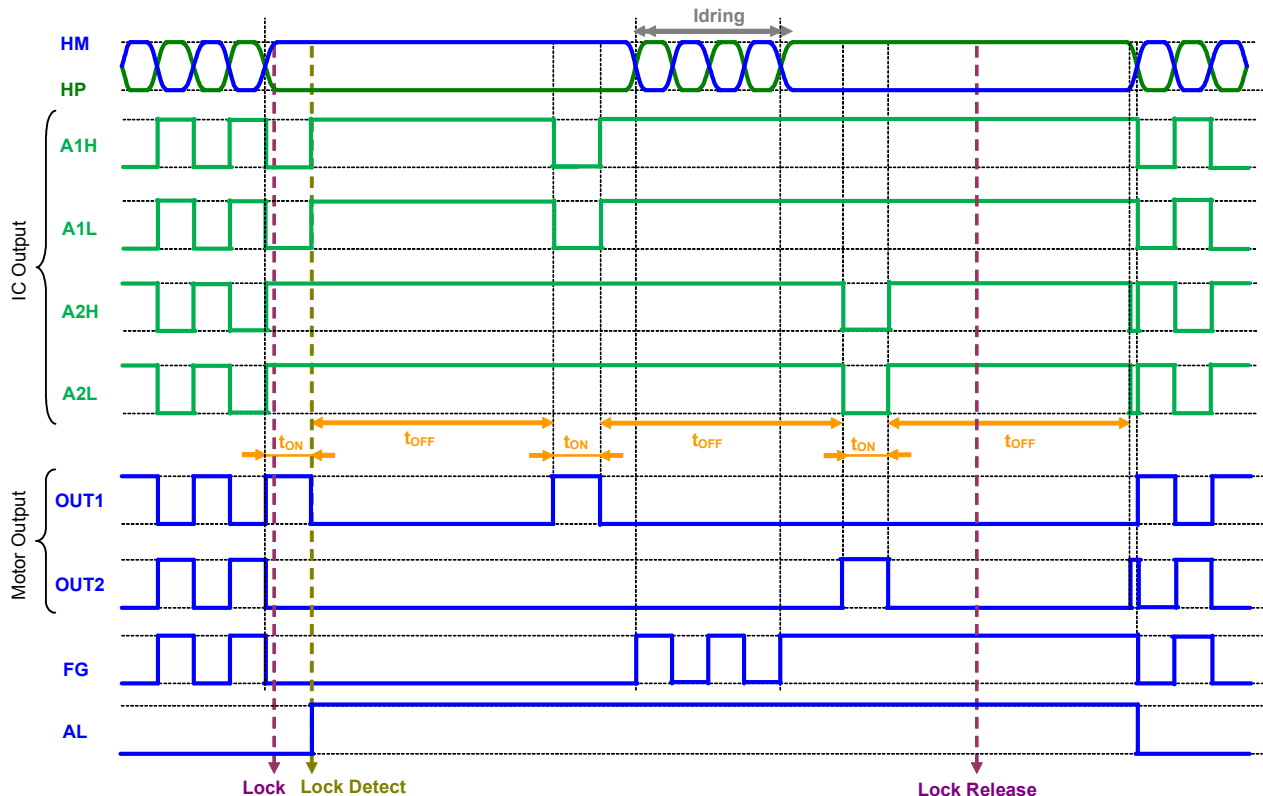

Figure 41. Lock Protection Timing Chart

11. High-speed detection protection

When a hall input signal is abnormally fast (more than 1.525kHz, 45,750rpm as 4 pole motor), the lock protection operation works. When noise is easy to appear in a hall input signal, please put a capacitor between hall input terminals like C1 of Figure 43.

10. Hall Input Setting

The input voltage of a hall signal is input in "Hall Input Voltage" in P.2 including signal amplitude. In order to detect rotation of a motor, the amplitude of hall signal more than "Hall Input Hysteresis" is required. Input the hall signal more than 30mVpp at least.

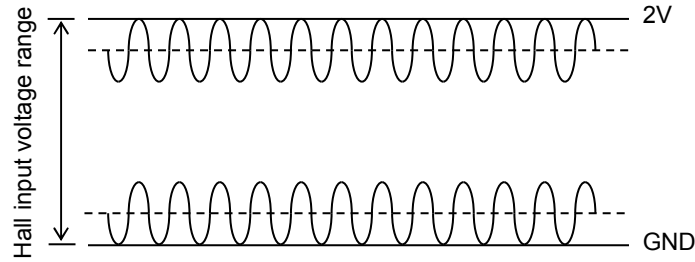

Figure 42. Hall Input Voltage Range

○Reducing the Noise of Hall Signal

Hall element may be affected by V_{CC} noise or the like depending on the wiring pattern of board. In this case, place a capacitor like C1 in Figure 43. In addition, when wiring from the hall element output to IC hall input is long, noise may be loaded on wiring. In this case, place a capacitor like C2 in Figure 43.

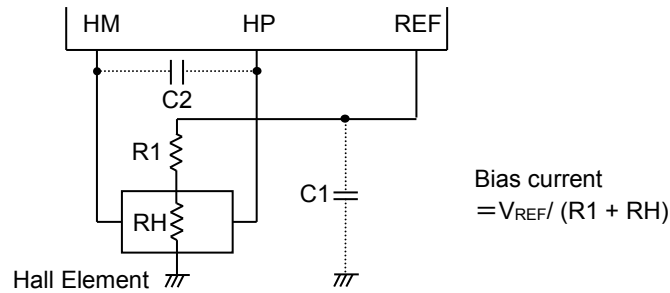
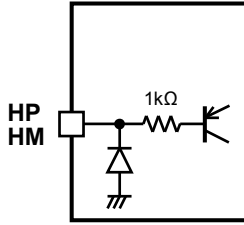

Figure 43. Application near of Hall Signal

I/O Equivalent Circuit

1. Hall signal input



2. PWM signal input

Drive PWM frequency select
 FG/AL signal select
 Standby mode enable select

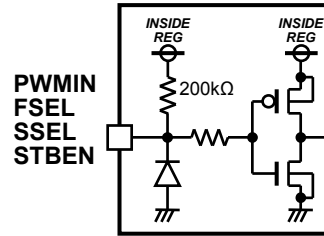

3. Current sensing

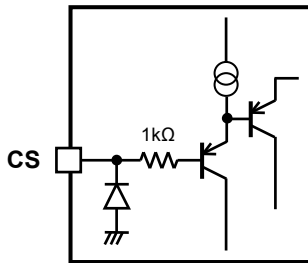

4. A/D converter input

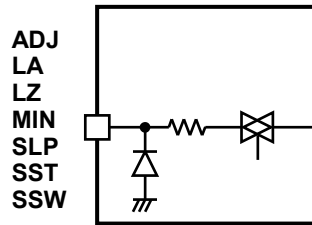

5. Reference voltage output

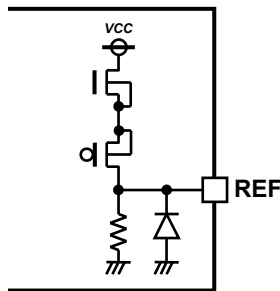

6. FG/AL signal output

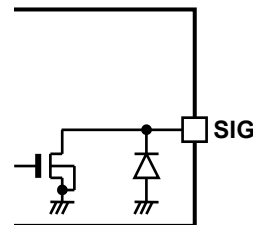

7. High side output

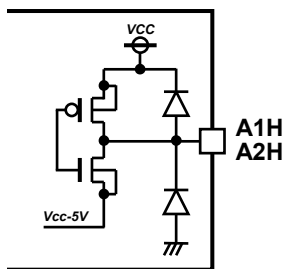

8. Low side output

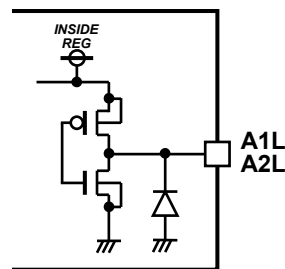

Safety Measure

1. Reverse Connection Protection Diode

Reverse connection of power results in IC destruction as shown in Figure 44. When reverse connection is possible, reverse connection protection diode must be added between power supply and VCC.

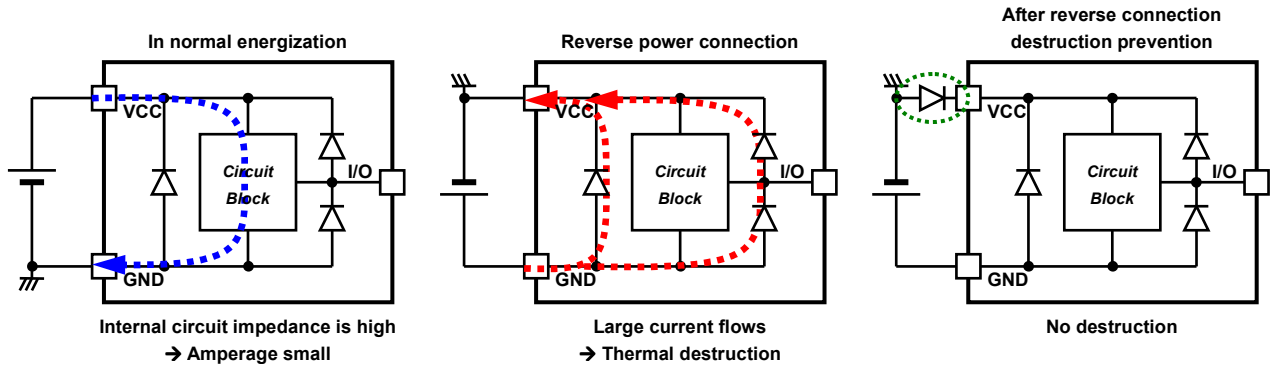

Figure 44. Flow of Current When Power is Connected Reversely

2. Problem of GND line PWM Switching

Do not perform PWM switching of GND line because GND terminal potential cannot be kept to a minimum.

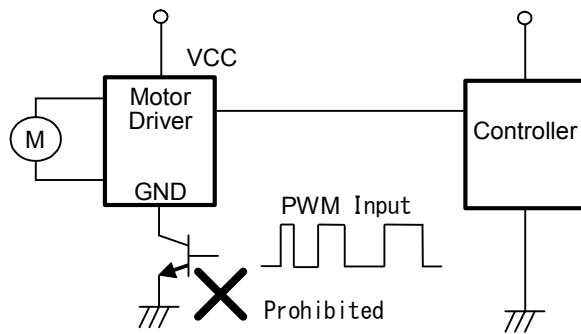

Figure 45. GND Line PWM Switching Prohibited

3. SIG Output

SIG is an open drain output and requires pull-up resistor. When SIG pin is directly connected to power supply, over inflow current may damage the IC. By adding protection resistor shown in Figure 46, IC is protected from over current.

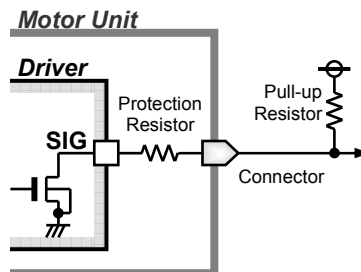

Figure 46. Protection of SIG terminal

Power Dissipation

1. Power Dissipation

Power dissipation indicates the power that can be consumed by IC at Ta=25°C. IC is heated when it consumes power, and the temperature of IC chip becomes higher than ambient temperature. The temperature that can be allowed by IC chip into the package is the absolute maximum rating of the junction temperature. And it depends on circuit configuration, manufacturing process, etc. Power dissipation is determined by this maximum junction temperature, thermal resistance of mounting condition, and ambient temperature. Therefore, when the power dissipation exceeds the absolute maximum rating, the operating temperature range is not a guarantee. The maximum junction temperature is in general equal to the maximum value in the storage temperature range.

2. Thermal Resistance

Heat generated by consumed power of IC is radiated from the mold resin or lead frame of package. The parameter which indicates this heat dissipation capability (hardness of heat release) is called thermal resistance. Thermal resistance from the chip junction to the ambient is represented in θ_{JA} [°C/W], and thermal characterization parameter from junction to the top center of the outside surface of the component package is represented in Ψ_{JT} [°C/W]. Thermal resistance is divide into the package part and the substrate part. Thermal resistance in the package part depends on the composition materials such as the mold resins and the lead frames. On the other hand, thermal resistance in the substrate part depends on the substrate heat dissipation capability of the material, the size, and the copper foil area etc. Therefore, thermal resistance can be decreased by the heat radiation measures like installing a heat sink etc. in the mounting substrate.

The thermal resistance model is shown in Figure 47, and equation is shown below.

$$\theta_{JA} = (T_j - T_a) / P \text{ [°C/W]}$$

$$\Psi_{JT} = (T_j - T_t) / P \text{ [°C/W]}$$

where:

- θ_{JA} is the thermal resistance from junction to ambient [°C/W]
- Ψ_{JT} is the thermal characterization parameter from junction to the top center of the outside surface of the component package [°C/W]
- T_j is the junction temperature [°C]
- T_a is the ambient temperature [°C]
- T_t is the package outside surface (top center) temperature [°C]
- P is the power consumption [W]

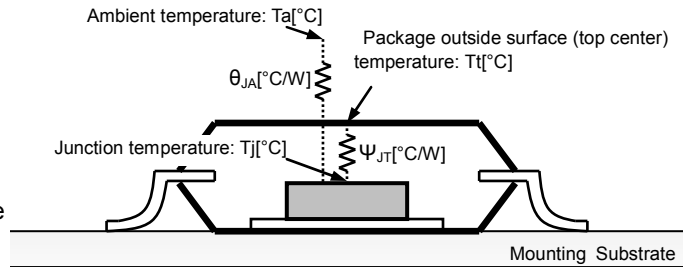

Figure 47. Thermal Resistance Model of Surface Mount

Even if it uses the same package, θ_{JA} and Ψ_{JT} are changed depending on the chip size, power consumption, and the measurement environments of the ambient temperature, the mounting condition, and the wind velocity, etc.

3. Thermal De-rating Curve

Thermal de-rating curve indicates the power that can be consumed by the IC with reference to ambient temperature. Power that can be consumed by IC begins to attenuate at ambient temperature 25°C, and becomes 0W at the maximum junction temperature 150°C. The inclination is reduced by the reciprocal of thermal resistance θ_{ja} . The thermal de-rating curve under a condition of thermal resistance (P.2) is shown in Figure 48.

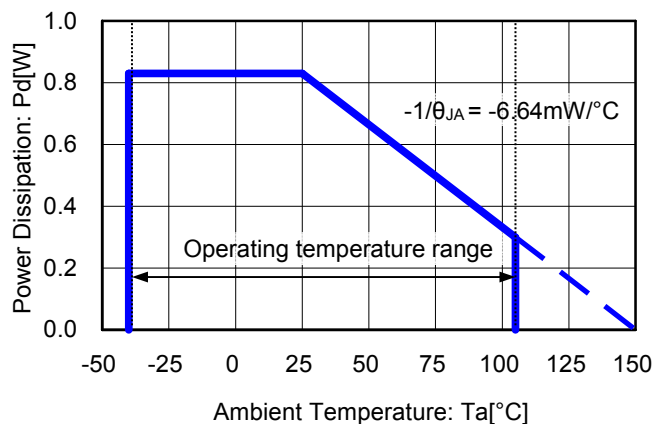

Figure 48. Power Dissipation vs Ambient Temperature

Operational Notes

1. Reverse Connection of Power Supply

Connecting the power supply in reverse polarity can damage the IC. Take precautions against reverse polarity when connecting the power supply, such as mounting an external diode between the power supply and the IC's power supply pins.

2. Power Supply Lines

Design the PCB layout pattern to provide low impedance supply lines. Furthermore, connect a capacitor to ground at all power supply pins. Consider the effect of temperature and aging on the capacitance value when using electrolytic capacitors.

3. Ground Voltage

Ensure that no pins are at a voltage below that of the ground pin at any time, even during transient condition. However, pins that drive inductive loads (e.g. motor driver outputs, DC-DC converter outputs) may inevitably go below ground due to back EMF or electromotive force. In such cases, the user should make sure that such voltages going below ground will not cause the IC and the system to malfunction by examining carefully all relevant factors and conditions such as motor characteristics, supply voltage, operating frequency and PCB wiring to name a few.

4. Ground Wiring Pattern

When using both small-signal and large-current ground traces, the two ground traces should be routed separately but connected to a single ground at the reference point of the application board to avoid fluctuations in the small-signal ground caused by large currents. Also ensure that the ground traces of external components do not cause variations on the ground voltage. The ground lines must be as short and thick as possible to reduce line impedance.

5. Recommended Operating Conditions

These conditions represent a range within which the expected characteristics of the IC can be approximately obtained. The electrical characteristics are guaranteed under the conditions of each parameter.

6. Inrush Current

When power is first supplied to the IC, it is possible that the internal logic may be unstable and inrush current may flow instantaneously due to the internal powering sequence and delays, especially if the IC has more than one power supply. Therefore, give special consideration to power coupling capacitance, power wiring, width of ground wiring, and routing of connections.

7. Operation Under Strong Electromagnetic Field

Operating the IC in the presence of a strong electromagnetic field may cause the IC to malfunction.

8. Testing on Application Boards

When testing the IC on an application board, connecting a capacitor directly to a low-impedance output pin may subject the IC to stress. Always discharge capacitors completely after each process or step. The IC's power supply should always be turned off completely before connecting or removing it from the test setup during the inspection process. To prevent damage from static discharge, ground the IC during assembly and use similar precautions during transport and storage.

Operational Notes – continued

9. Inter-pin Short and Mounting Errors

Ensure that the direction and position are correct when mounting the IC on the PCB. Incorrect mounting may result in damaging the IC. Avoid nearby pins being shorted to each other especially to ground, power supply and output pin. Inter-pin shorts could be due to many reasons such as metal particles, water droplets (in very humid environment) and unintentional solder bridge deposited in between pins during assembly to name a few.

10. Unused Input Pins

Input pins of an IC are often connected to the gate of a MOS transistor. The gate has extremely high impedance and extremely low capacitance. If left unconnected, the electric field from the outside can easily charge it. The small charge acquired in this way is enough to produce a significant effect on the conduction through the transistor and cause unexpected operation of the IC. So unless otherwise specified, unused input pins should be connected to the power supply or ground line.

11. Regarding the Input Pin of the IC

This monolithic IC contains P+ isolation and P substrate layers between adjacent elements in order to keep them isolated. P-N junctions are formed at the intersection of the P layers with the N layers of other elements, creating a parasitic diode or transistor. For example (refer to figure below):

When $GND > Pin A$ and $GND > Pin B$, the P-N junction operates as a parasitic diode.
 When $GND > Pin B$, the P-N junction operates as a parasitic transistor.

Parasitic diodes inevitably occur in the structure of the IC. The operation of parasitic diodes can result in mutual interference among circuits, operational faults, or physical damage. Therefore, conditions that cause these diodes to operate, such as applying a voltage lower than the GND voltage to an input pin (and thus to the P substrate) should be avoided.

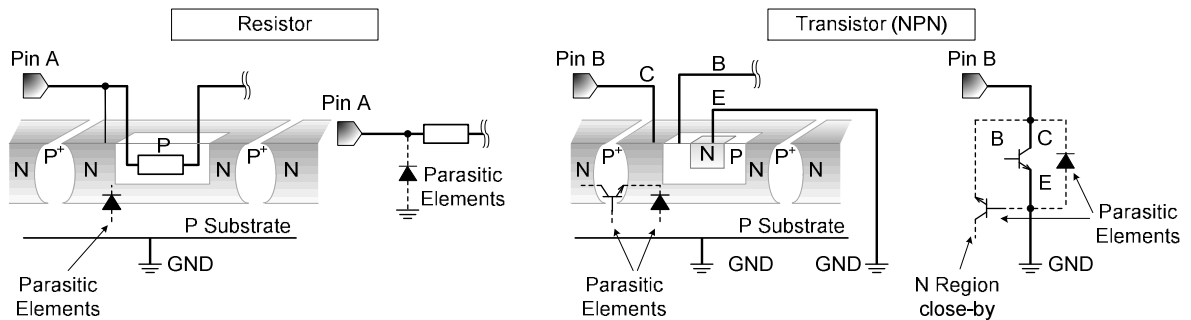

Figure 49. Example of monolithic IC structure

12. Ceramic Capacitor

When using a ceramic capacitor, determine a capacitance value considering the change of capacitance with temperature and the decrease in nominal capacitance due to DC bias and others.

13. Area of Safe Operation (ASO)

Operate the IC such that the output voltage, output current, and power dissipation are all within the Area of Safe Operation (ASO).

14. Thermal Shutdown (TSD) Circuit

This IC has a built-in thermal shutdown circuit that prevents heat damage to the IC. Normal operation should always be within the IC's maximum junction temperature rating. If however the rating is exceeded for a continued period, the junction temperature (T_j) will rise which will activate the TSD circuit that will turn OFF power output pins. When the T_j falls below the TSD threshold, the circuits are automatically restored to normal operation.

Note that the TSD circuit operates in a situation that exceeds the absolute maximum ratings and therefore, under no circumstances, should the TSD circuit be used in a set design or for any purpose other than protecting the IC from heat damage.

Ordering Information

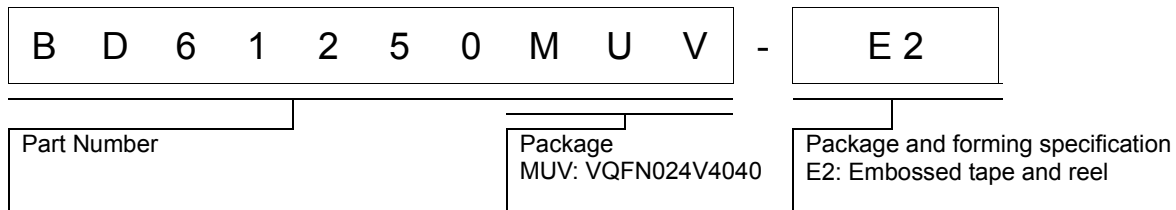

Marking Diagram

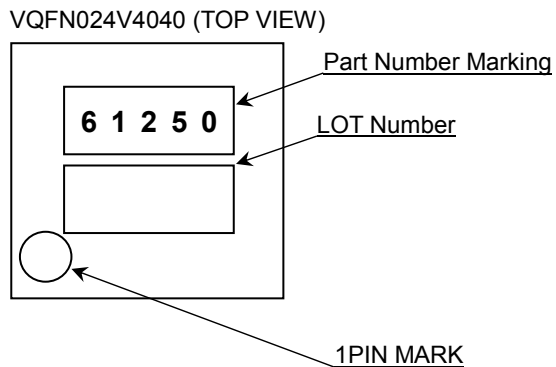

Physical Dimension and Packing Information

Package Name	VQFN024V4040
--------------	--------------

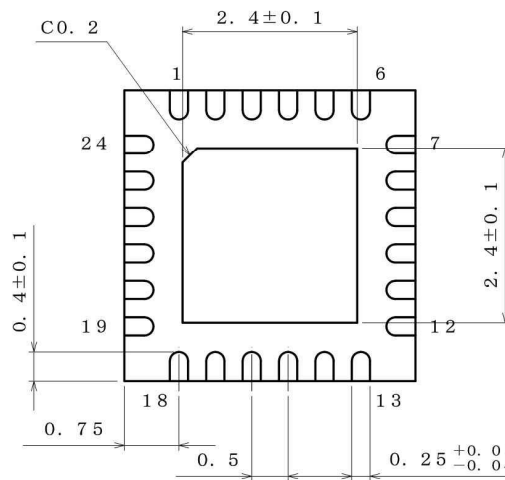
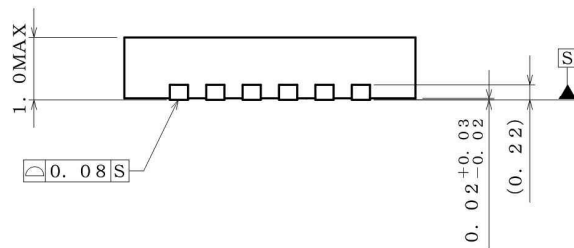
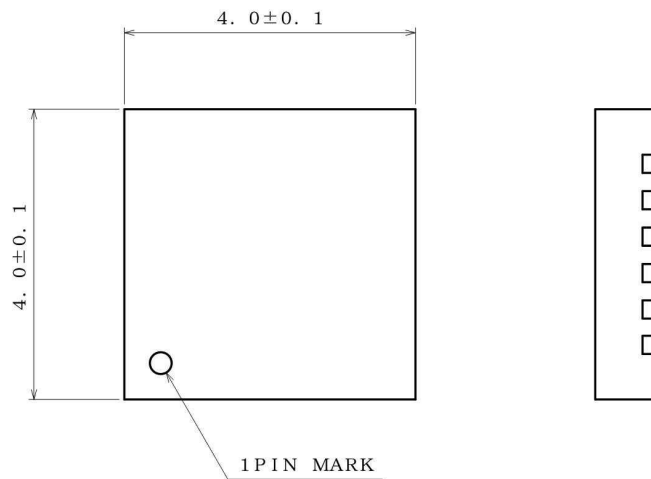

(UNIT : mm)
 PKG : VQFN024V4040
 Drawing No. EX463-5001-2

<Tape and Reel information>

Tape	Embossed carrier tape
Quantity	2500pcs
Direction of feed	E2 (The direction is the 1pin of product is at the upper left when you hold reel on the left hand and you pull out the tape on the right hand)

*Order quantity needs to be multiple of the minimum quantity.

Notice

Precaution on using ROHM Products

- Our Products are designed and manufactured for application in ordinary electronic equipments (such as AV equipment, OA equipment, telecommunication equipment, home electronic appliances, amusement equipment, etc.). If you intend to use our Products in devices requiring extremely high reliability (such as medical equipment ^(Note 1), transport equipment, traffic equipment, aircraft/spacecraft, nuclear power controllers, fuel controllers, car equipment including car accessories, safety devices, etc.) and whose malfunction or failure may cause loss of human life, bodily injury or serious damage to property ("Specific Applications"), please consult with the ROHM sales representative in advance. Unless otherwise agreed in writing by ROHM in advance, ROHM shall not be in any way responsible or liable for any damages, expenses or losses incurred by you or third parties arising from the use of any ROHM's Products for Specific Applications.

(Note1) Medical Equipment Classification of the Specific Applications

JAPAN	USA	EU	CHINA
CLASS III	CLASS III	CLASS II b	CLASS III
CLASS IV		CLASS III	

- ROHM designs and manufactures its Products subject to strict quality control system. However, semiconductor products can fail or malfunction at a certain rate. Please be sure to implement, at your own responsibilities, adequate safety measures including but not limited to fail-safe design against the physical injury, damage to any property, which a failure or malfunction of our Products may cause. The following are examples of safety measures:
 - Installation of protection circuits or other protective devices to improve system safety
 - Installation of redundant circuits to reduce the impact of single or multiple circuit failure
- Our Products are designed and manufactured for use under standard conditions and not under any special or extraordinary environments or conditions, as exemplified below. Accordingly, ROHM shall not be in any way responsible or liable for any damages, expenses or losses arising from the use of any ROHM's Products under any special or extraordinary environments or conditions. If you intend to use our Products under any special or extraordinary environments or conditions (as exemplified below), your independent verification and confirmation of product performance, reliability, etc. prior to use, must be necessary:
 - Use of our Products in any types of liquid, including water, oils, chemicals, and organic solvents
 - Use of our Products outdoors or in places where the Products are exposed to direct sunlight or dust
 - Use of our Products in places where the Products are exposed to sea wind or corrosive gases, including Cl₂, H₂S, NH₃, SO₂, and NO₂
 - Use of our Products in places where the Products are exposed to static electricity or electromagnetic waves
 - Use of our Products in proximity to heat-producing components, plastic cords, or other flammable items
 - Sealing or coating our Products with resin or other coating materials
 - Use of our Products without cleaning residue of flux (even if you use no-clean type fluxes, cleaning residue of flux is recommended); or Washing our Products by using water or water-soluble cleaning agents for cleaning residue after soldering
 - Use of the Products in places subject to dew condensation
- The Products are not subject to radiation-proof design.
- Please verify and confirm characteristics of the final or mounted products in using the Products.
- In particular, if a transient load (a large amount of load applied in a short period of time, such as pulse. is applied, confirmation of performance characteristics after on-board mounting is strongly recommended. Avoid applying power exceeding normal rated power; exceeding the power rating under steady-state loading condition may negatively affect product performance and reliability.
- De-rate Power Dissipation depending on ambient temperature. When used in sealed area, confirm that it is the use in the range that does not exceed the maximum junction temperature.
- Confirm that operation temperature is within the specified range described in the product specification.
- ROHM shall not be in any way responsible or liable for failure induced under deviant condition from what is defined in this document.

Precaution for Mounting / Circuit board design

- When a highly active halogenous (chlorine, bromine, etc.) flux is used, the residue of flux may negatively affect product performance and reliability.
- In principle, the reflow soldering method must be used on a surface-mount products, the flow soldering method must be used on a through hole mount products. If the flow soldering method is preferred on a surface-mount products, please consult with the ROHM representative in advance.

For details, please refer to ROHM Mounting specification

Precautions Regarding Application Examples and External Circuits

1. If change is made to the constant of an external circuit, please allow a sufficient margin considering variations of the characteristics of the Products and external components, including transient characteristics, as well as static characteristics.
2. You agree that application notes, reference designs, and associated data and information contained in this document are presented only as guidance for Products use. Therefore, in case you use such information, you are solely responsible for it and you must exercise your own independent verification and judgment in the use of such information contained in this document. ROHM shall not be in any way responsible or liable for any damages, expenses or losses incurred by you or third parties arising from the use of such information.

Precaution for Electrostatic

This Product is electrostatic sensitive product, which may be damaged due to electrostatic discharge. Please take proper caution in your manufacturing process and storage so that voltage exceeding the Products maximum rating will not be applied to Products. Please take special care under dry condition (e.g. Grounding of human body / equipment / solder iron, isolation from charged objects, setting of Ionizer, friction prevention and temperature / humidity control).

Precaution for Storage / Transportation

1. Product performance and soldered connections may deteriorate if the Products are stored in the places where:
 - [a] the Products are exposed to sea winds or corrosive gases, including Cl₂, H₂S, NH₃, SO₂, and NO₂
 - [b] the temperature or humidity exceeds those recommended by ROHM
 - [c] the Products are exposed to direct sunshine or condensation
 - [d] the Products are exposed to high Electrostatic
2. Even under ROHM recommended storage condition, solderability of products out of recommended storage time period may be degraded. It is strongly recommended to confirm solderability before using Products of which storage time is exceeding the recommended storage time period.
3. Store / transport cartons in the correct direction, which is indicated on a carton with a symbol. Otherwise bent leads may occur due to excessive stress applied when dropping of a carton.
4. Use Products within the specified time after opening a humidity barrier bag. Baking is required before using Products of which storage time is exceeding the recommended storage time period.

Precaution for Product Label

A two-dimensional barcode printed on ROHM Products label is for ROHM's internal use only.

Precaution for Disposition

When disposing Products please dispose them properly using an authorized industry waste company.

Precaution for Foreign Exchange and Foreign Trade act

Since concerned goods might be fallen under listed items of export control prescribed by Foreign exchange and Foreign trade act, please consult with ROHM in case of export.

Precaution Regarding Intellectual Property Rights

1. All information and data including but not limited to application example contained in this document is for reference only. ROHM does not warrant that foregoing information or data will not infringe any intellectual property rights or any other rights of any third party regarding such information or data.
2. ROHM shall not have any obligations where the claims, actions or demands arising from the combination of the Products with other articles such as components, circuits, systems or external equipment (including software).
3. No license, expressly or implied, is granted hereby under any intellectual property rights or other rights of ROHM or any third parties with respect to the Products or the information contained in this document. Provided, however, that ROHM will not assert its intellectual property rights or other rights against you or your customers to the extent necessary to manufacture or sell products containing the Products, subject to the terms and conditions herein.

Other Precaution

1. This document may not be reprinted or reproduced, in whole or in part, without prior written consent of ROHM.
2. The Products may not be disassembled, converted, modified, reproduced or otherwise changed without prior written consent of ROHM.
3. In no event shall you use in any way whatsoever the Products and the related technical information contained in the Products or this document for any military purposes, including but not limited to, the development of mass-destruction weapons.
4. The proper names of companies or products described in this document are trademarks or registered trademarks of ROHM, its affiliated companies or third parties.

General Precaution

1. Before you use our Products, you are requested to carefully read this document and fully understand its contents. ROHM shall not be in any way responsible or liable for failure, malfunction or accident arising from the use of any ROHM's Products against warning, caution or note contained in this document.
2. All information contained in this document is current as of the issuing date and subject to change without any prior notice. Before purchasing or using ROHM's Products, please confirm the latest information with a ROHM sales representative.
3. The information contained in this document is provided on an "as is" basis and ROHM does not warrant that all information contained in this document is accurate and/or error-free. ROHM shall not be in any way responsible or liable for any damages, expenses or losses incurred by you or third parties resulting from inaccuracy or errors of or concerning such information.



BD61250MUV - Web Page

[Distribution Inventory](#)

Part Number	BD61250MUV
Package	VQFN024V4040
Unit Quantity	2500
Minimum Package Quantity	2500
Packing Type	Taping
Constitution Materials List	inquiry
RoHS	Yes