

DRV11873 12V、三相无传感器、无刷直流 (BLDC) 电机驱动器

1 特性

- 输入电压范围：5V 至 16V
- 六个具有 1.5V 持续输出电流的集成金属氧化物半导体场效应晶体管 (MOSFET)
- 总驱动器 H+L $R_{DS(ON)}$ ：450m Ω
- 无传感器私有 BMEF 控制系统配置
- 150°整流
- 同步整流脉宽调制 (PWM) 操作
- FG 和 RD 开漏输出
- 适合外部使用的 5V LDO，电流高达 20mA
- 7kHz 至 100kHz 的 PWM_{IN} 输入
- 过电流保护，限值可通过外部电阻调节
- 锁定检测
- 电压浪涌保护
- 欠压闭锁 (UVLO)
- 热关断

2 应用范围

- 电器冷却风扇
- 台式机冷却风扇
- 服务器冷却风扇

3 说明

DRV11873 是一款具有集成功率 MOSFET 的三相无传感器电机驱动器，连续驱动电流达 1.5A，峰值驱动电流高达 2A。DRV11873 专为风扇电机驱动应用设计，噪声低且所需的外部组件数量少。DRV11873 具有内置过电流保护，无需外部电流感测电阻。同步整流运行模式可提高电机驱动器应用的效率。DRV11873 通过开漏输出端输出 FG 和 RD 以指示电机状态。该器件实现了适合三相电机的 150° 无传感器反电动势 (BEMF) 控制方案。DRV11873 采用高效散热型 16 引脚 TSSOP 封装。额定工作温度为 -40°C 至 125°C。

器件信息⁽¹⁾

器件型号	封装	封装尺寸 (标称值)
DRV11873	HTSSOP (16)	4.40mm x 5.00mm

(1) 要了解所有可用封装，请见数据表末尾的可订购产品附录。

4 简化电路原理图

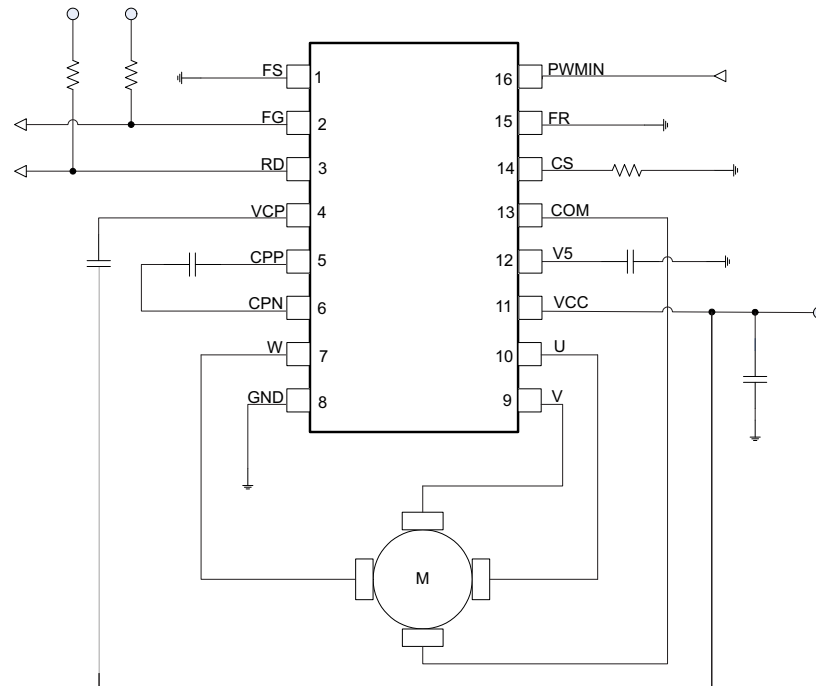

目录

1	特性	1	8.2	Functional Block Diagram	9
2	应用范围	1	8.3	Feature Description	10
3	说明	1	8.4	Device Functional Modes	11
4	简化电路原理图	1	9	Application and Implementation	13
5	修订历史记录	2	9.1	Application Information	13
6	Pin Configuration and Functions	3	9.2	Typical Application	13
7	Specifications	4	10	Power Supply Recommendations	15
	7.1 Absolute Maximum Ratings	4	11	Layout	15
	7.2 Handling Ratings	4	11.1	Layout Guidelines	15
	7.3 Recommended Operating Conditions	4	11.2	Layout Example	15
	7.4 Thermal Information	5	12	器件和文档支持	16
	7.5 Electrical Characteristics	6	12.1	商标	16
	7.6 Typical Characteristics	7	12.2	静电放电警告	16
8	Detailed Description	9	12.3	术语表	16
	8.1 Overview	9	13	机械、封装和可订购信息	16

5 修订历史记录

Changes from Original (November 2012) to Revision A	Page
• 已添加处理额定值表，特性描述部分，器件功能模式，应用和实施部分，电源相关建议部分，布局部分，器件和文档支持部分以及机械、封装和可订购信息部分	1
• Changed f_{PWM} minimum value	6

6 Pin Configuration and Functions

**PWP Package
16 Pins
(Top View)**

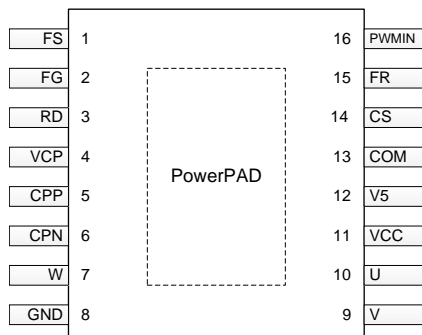

Pin Functions

PIN		I/O ⁽¹⁾	DESCRIPTION
NAME	NO.		
FS	1	I	Motor parameter adjustment pin. Pull low for lower-speed motor and pull high for high-speed motor.
FG	2	O	Frequency generator output. The output period is equal to 6 electrical states (FG).
RD	3	O	In the lock condition, RD output is high through a pullup resistor to V _{CC} or 5 V.
VCP	4	O	Charge pump output
CPP	5	O	Charge pump conversion terminal
CPN	6	O	Charge pump conversion terminal
W	7	O	Phase W output
GND	8	—	Ground pin
V	9	O	Phase V output
U	10	O	Phase U output
VCC	11	I	Input voltage for motor and chip supply voltage
V5	12	O	5-V regulator output
COM	13	I	Motor common terminal input. If the motor does not have a common wire, see Application and Implementation for more details.
CS	14	I	Overcurrent threshold set-up pin. A resistor set-up current limit is connected between this pin and ground. The voltage across the resistor compares with the voltage converted from the bottom MOSFETs' current. If MOSFETs' current is high, the part goes into the overcurrent protection mode by turning off the top PWM MOSFET and keeping the bottom MOSFET on. $I_{limit}(A) = 6600 / R_{CS} (\Omega)$; Equation valid range: 500 mA < I _{limit} < 2000 mA
FR	15	I	Set high for reverse rotation. Set low or floating for forward rotation.
PWMIN	16	I	PWM input pin. The PWM input signal is converted to a fixed switching frequency on the MOSFET driver.

(1) I = input, O = output, N/A = not available

7 Specifications

7.1 Absolute Maximum Ratings

over operating free-air temperature (unless otherwise noted)

		MIN	MAX	UNIT
Input voltage ⁽¹⁾	VCC	-0.3	20	V
	CS	-0.3	3.6	
	PWMIN, FS, FR	-0.3	6	
	GND	-0.3	0.3	
	COM	-1	20	
Output voltage ⁽¹⁾	U, V, W	-1	20	V
	FG, RD	-0.3	20	
	VCP	-0.3	25	
	CPN	-0.3	20	
	CPP	-0.3	25	
	V5	-0.3	6	
T _J	Operating junction temperature	-40	125	°C

(1) Voltage values are with respect to the network ground terminal unless otherwise noted.

7.2 Handling Ratings

		MIN	MAX	UNIT	
T _{stg}	Storage temperature range	-55	150	°C	
V _(ESD)	Electrostatic discharge	Human body model (HBM), per ANSI/ESDA/JEDEC JS-001, all pins ⁽¹⁾	-4000	4000	V
		Charged device model (CDM), per JEDEC specification JESD22-C101, all pins ⁽²⁾	-1000	1000	
		Machine model (MM)	-200	200	

(1) JEDEC document JEP155 states that 500-V HBM allows safe manufacturing with a standard ESD control process.

(2) JEDEC document JEP157 states that 250-V CDM allows safe manufacturing with a standard ESD control process.

7.3 Recommended Operating Conditions

over operating free-air temperature range (unless otherwise noted)

		MIN	MAX	UNIT
Supply voltage	VCC	5	16	V
Voltage range	U, V, W	-0.7	17	V
	COM	-0.1	17	
	FG, RD	-0.1	16	
	PGND, GND	-0.1	0.1	
	VCP	-0.1	22	
	CPP	-0.1	22	
	CPN	-0.1	16	
	V5	-0.1	5.5	
PWMIN, FR, FS	-0.1	5.5		
T _J	Operating junction temperature	-40	125	V

7.4 Thermal Information

THERMAL METRIC ⁽¹⁾		DRV11873	UNIT
		PWP	
		16 PINS	
$R_{\theta JA}$	Junction-to-ambient thermal resistance	39.4	°C/W
$R_{\theta JC(top)}$	Junction-to-case (top) thermal resistance	30.3	
$R_{\theta JB}$	Junction-to-board thermal resistance	25.6	
Ψ_{JT}	Junction-to-top characterization parameter	0.5	
Ψ_{JB}	Junction-to-board characterization parameter	10.2	
$R_{\theta JC(bot)}$	Junction-to-case (bottom) thermal resistance	3.6	

(1) For more information about traditional and new thermal metrics, see the *IC Package Thermal Metrics* application report, [SPRA953](#).

7.5 Electrical Characteristics

over recommended operating free-air temperature (unless otherwise noted)

PARAMETER		TEST CONDITIONS	MIN	TYP	MAX	UNIT
SUPPLY CURRENT						
I_{VCC}	Supply current	$T_A = 25^\circ\text{C}$; PWM = V_{CC} ; $V_{CC} = 12\text{ V}$		2.7	5	mA
UVLO						
$V_{UVLO-th_r}$	UVLO threshold voltage	Rise threshold, $T_A = 25^\circ\text{C}$		4.3	4.6	V
$V_{UVLO-th_f}$	UVLO threshold voltage	Fall threshold, $T_A = 25^\circ\text{C}$	3.9	4.1		V
$V_{UVLO-thhys}$	UVLO threshold voltage hysteresis	$T_A = 25^\circ\text{C}$	100	200	300	mV
INTEGRATED MOSFET						
$R_{DS(on)}$	Series resistance (H + L)	$T_A = 25^\circ\text{C}$; $V_{CC} = 12\text{ V}$; $V_{CP} = 19\text{ V}$; $I_{OUT} = 1.5\text{ A}$		0.45	0.6	Ω
PWM						
V_{PWM-IH}	High-level input voltage	$V_{CC} \geq 4.5\text{ V}$	2.7			V
V_{PWM-IL}	Low-level input voltage	$V_{CC} \geq 4.5\text{ V}$			0.8	V
f_{PWM}	PWM input frequency		7		100	kHz
$I_{PWM-SOURCE}$	PWM source current		35	50	65	μA
FG						
$I_{FG-SINK}$	FG pin sink current	$V_{FG} = 0.3\text{ V}$	5			mA
$I_{FG-short}$	FG pin short current limit	$V_{FG} = 12\text{ V}$		20	25	mA
RD						
$I_{RD-SINK}$	RD pin sink current	$V_{RD} = 0.3\text{ V}$	5			mA
$I_{RD-short}$	RD pin short current limit	$V_{RD} = 12\text{ V}$		20	25	mA
FR and FS						
V_{FR-IH}	High-level input voltage	$V_{CC} \geq 4.5\text{ V}$	2.3			V
V_{FR-IL}	Low-level input voltage	$V_{CC} \geq 4.5\text{ V}$			0.8	V
V_{FS-th}	FS set threshold voltage	$V_{CC} \geq 4.5\text{ V}$	2.3		0.8	V
V5						
V5	5-V LDO voltage	$V_{CC} = 12\text{ V}$	4.75	5	5.25	V
I_{V5}	5-V LDO load current	$V_{CC} = 12\text{ V}$		20		mA
LOCK PROTECTION						
$t_{LOCK-ON}$	Lock detect time	FS = 0	0.875	1.25	1.625	s
		FS = 1	0.437	0.625	0.812	
$t_{LOCK-OFF}$	Lock release time	FS = 0	4.375	6.25	8.125	s
		FS = 1	2.187	3.125	4.06	
CURRENT LIMIT						
	Current limit	CS pin to GND resistor = 3.3 k Ω	1.7	2	2.3	A
THERMAL SHUTDOWN						
T_{SDN}	Shutdown temperature threshold	Shutdown temperature		160		$^\circ\text{C}$
		Hysteresis		10		

7.6 Typical Characteristics

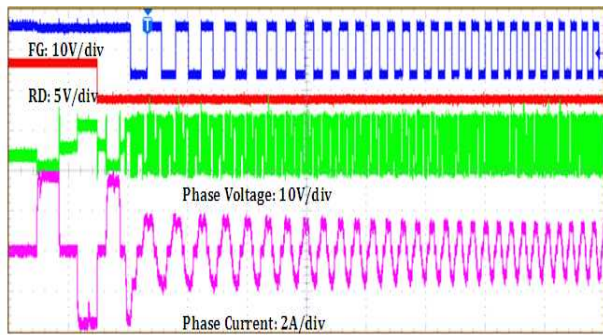

Input voltage = 12 V PWM duty = 100% FS = 1
t = 20 ms/div

Figure 1. Start Up at 100% Duty

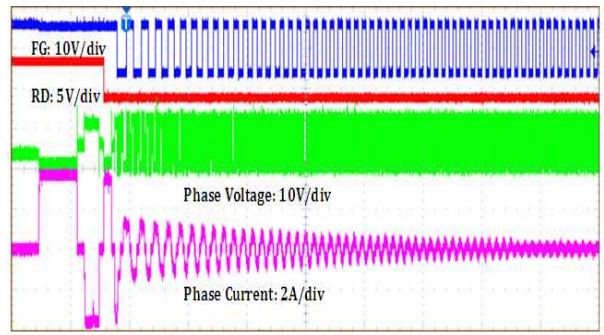

Input voltage = 12 V PWM duty = 10% FS = 1
t = 40 ms/div

Figure 2. Start Up at 10% Duty

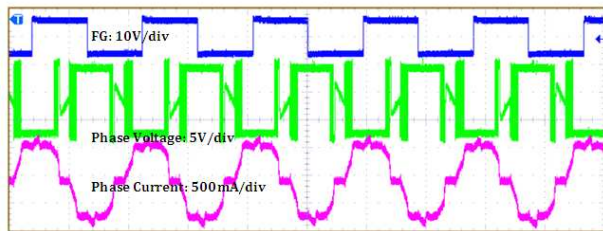

Input voltage = 12 V PWM duty = 100% FS = 1
t = 800 μs/div

Figure 3. Normal Operation at 100% Duty

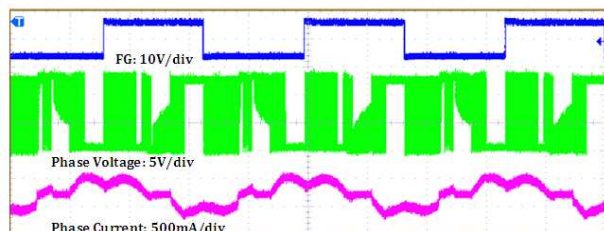

Input voltage = 12 V PWM duty = 50% FS = 1
t = 800 μs/div

Figure 4. Normal Operation at 50% Duty

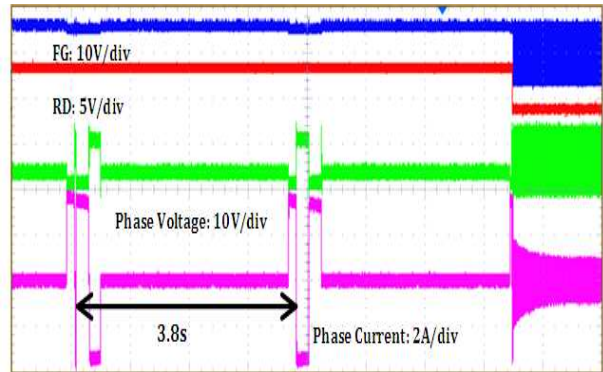

Input voltage = 12 V PWM duty = 100% FS = 1
t = 1 s/div

Figure 5. Lock Protection

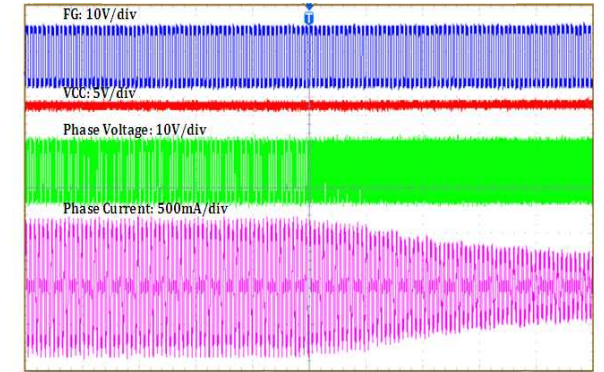

Input voltage = 12 V PWM duty switch from 100% to 20%
t = 20 ms/div FS = 1

Figure 6. AVS Operation

Typical Characteristics (continued)

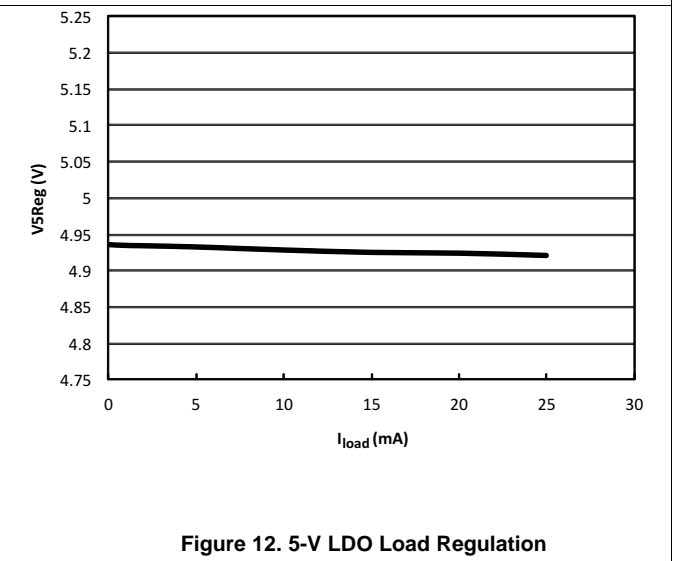
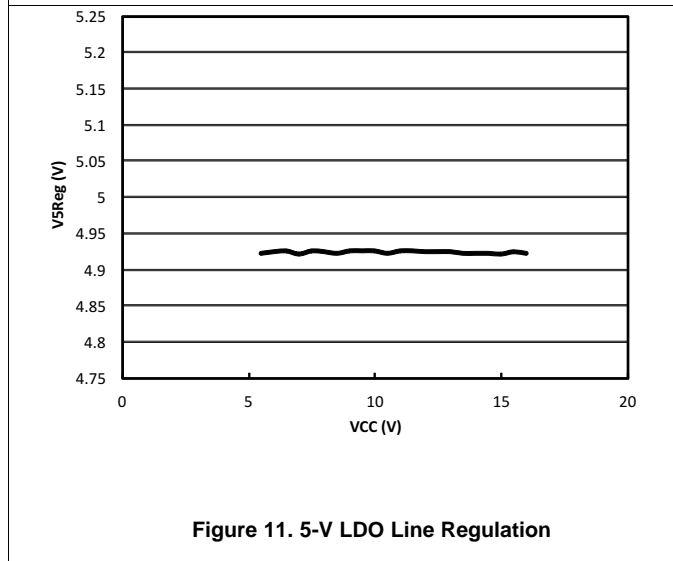
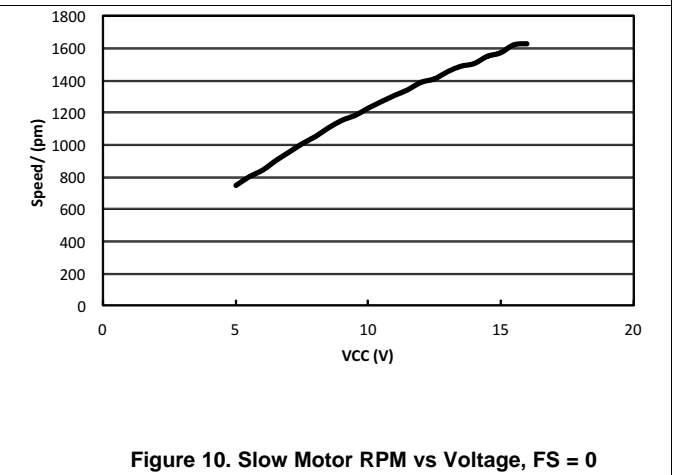
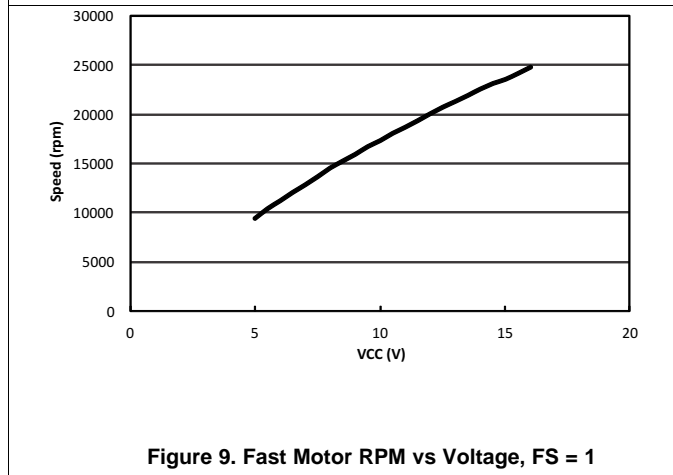
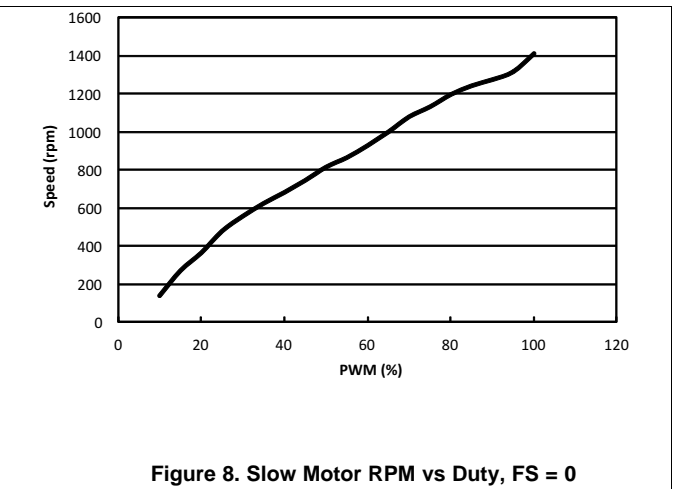
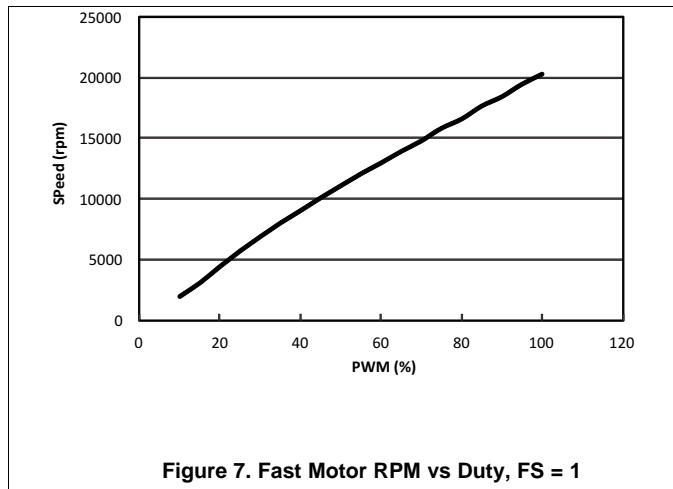

8 Detailed Description

8.1 Overview

DRV11873 is a three-phase, sensorless motor driver with integrated power MOSFETs with drive current capability up to 1.5-A continuous and 2-A peak. It is specifically designed for fan motor drive applications with low noise and low external component count. DRV11873 has built-in overcurrent protection with no external current sense resistor needed. The synchronous rectification mode of operation achieves increased efficiency for motor driver applications. A 5-V LDO is available to provide up to 20 mA to an external load. DRV11873 outputs FG and RD to indicate motor status with open-drain output. A 150° sensorless BEMF control scheme was implemented for a three-phase motor. DRV11873 can fit a wide range of fan motors with the FS pin selection function. Motor speed can be controlled by adjusting V_{CC} or providing a PWM input. Voltage surge protection scheme prevents the input V_{CC} capacitor from overcharge during motor braking mode. DRV11873 has multiple built-in protection blocks including UVLO, overcurrent protection, lock protection, and thermal shutdown protection.

8.2 Functional Block Diagram

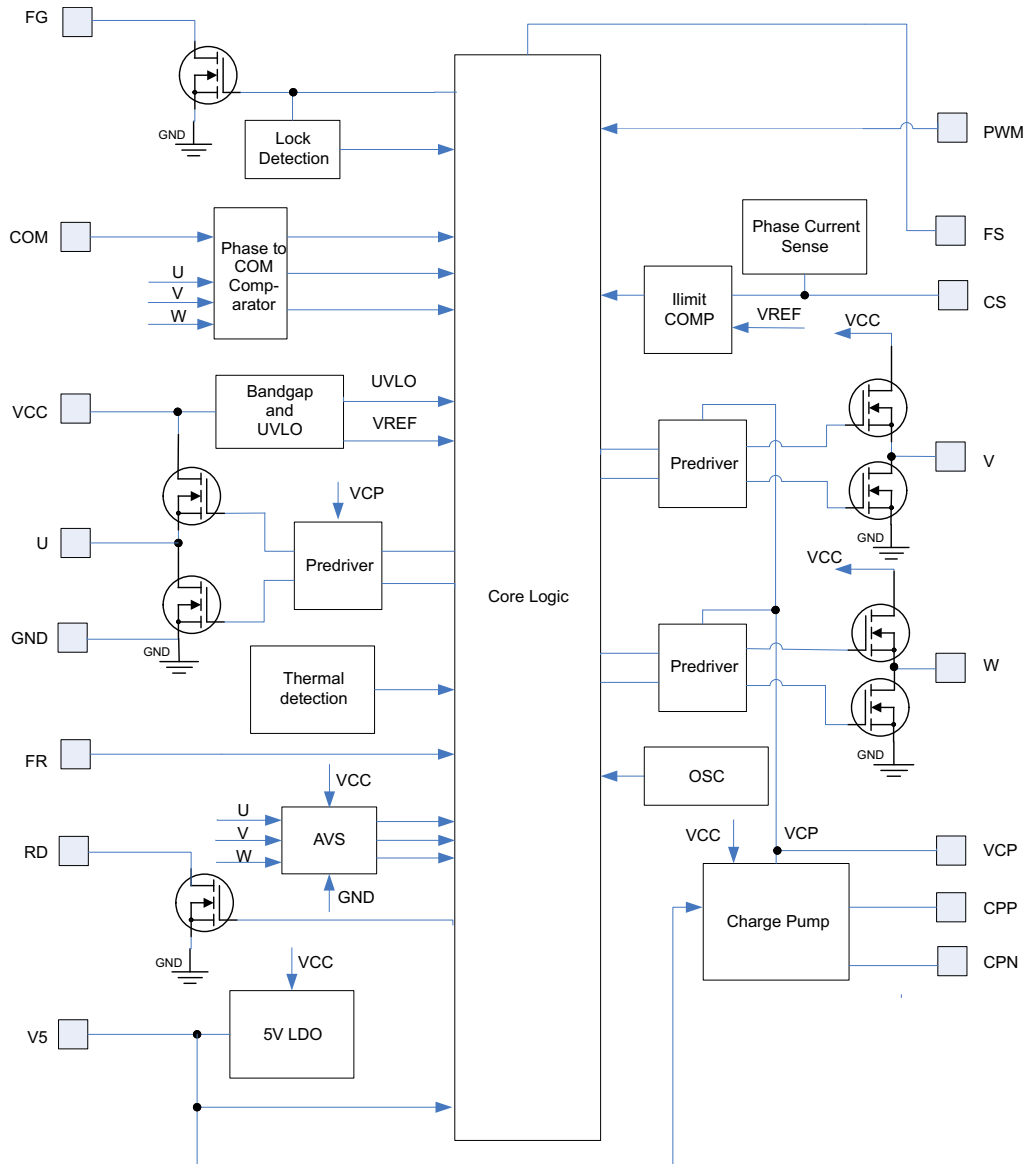

8.3 Feature Description

8.3.1 Speed Control

DRV11873 can control motor speed through either the PWM_{IN} or V_{CC} pin. Motor speed increases with higher PWM_{IN} duty cycle or V_{CC} input voltage. The curve of motor speed (RPM) vs PWM_{IN} duty cycle or V_{CC} input voltage is close to linear in most cases. However, motor characteristics affect the linearity of this speed curve. DRV11873 can operate at low V_{CC} input voltage ≥ 4.1 V. The PWM_{IN} pin is pulled up to V5 internally and the frequency range can vary from 7 to 100 kHz. The motor driver MOSFETs operate at a constant switching frequency of 125 kHz when the FS pin is pulled high and 62.5 kHz when the FS pin is pulled low. With this high switching frequency, DRV11873 can eliminate audible noise and reduce the ripple of V_{CC} input voltage and current.

8.3.2 Frequency Generator

The FG output is a 50% duty square wave output in the normal operation condition. Its frequency represents the motor speed and phase information. The FG pin is an open-drain output. An external pullup resistor is needed to connect any external system. During the start up, the FG output remains at high impedance until the motor speed reaches a certain level and BEMF is detected. If FG is not used, this pin can be left floating. The FG pin can be tied to either V5 or V_{CC} through a pullup resistor. Normally, the pullup resistor value can be 100 kΩ or higher. During lock protection, the FG output remains high until the lockout protection is dismissed and restart is completed. A current limit function is built in for the FG pin which prevents the open-drain MOSFET from damage if V_{CC} or V5 is accidentally connected to the FG pin. To calculate RPM based on FG frequency, refer to [Equation 1](#).

$$\text{RPM} = \frac{(\text{FG} \times 60)}{\text{pole pairs}}$$

where

- FG is in hertz (Hz)

(1)

8.3.3 FS Setting

DRV11873 can fit a wide range of fan motors by setting the FS pin. For high speed fan motors with low motor winding resistance and low inductance, the FS pin should be pulled high. For low speed fan motors with high motor winding resistance and high inductance, the FS pin should be pulled low. Through FS pin selection, DRV11873 can be used for wide applications from low-speed refrigerator cooling fans to high-speed server cooling fans. FS status can only be set during device power up.

8.3.4 Lock Protection and RD Output

If the motor is blocked or stopped by an external force, the lock protection will be triggered after detection time. During lock detection time, the circuit monitors the FG signal. If the FG output does not change state during the lock detection time, the lock protection will stop driving the motor. After lock release time, DRV11873 resumes driving the motor. If the lock condition is still present, DRV11873 proceeds with the next lock protection cycle until the lock condition is removed. With this lock protection, the motor and device do not get overheated or damaged. A different FS setting determines a different lock detection and lock release time. See the [Electrical Characteristics](#) for the different lock detection and release times.

The RD pin is an open-drain output which can be tied to either V5 or V_{CC} through a pullup resistor. Normally, the pullup resistor value can be 100 kΩ or higher. During the lock protection condition, the RD output remains high until the lock protection is dismissed and restart is completed. A current limit function is built in for the RD pin which prevents the open-drain MOSFET from damage if V_{CC} or V5 is accidentally connected to the RD pin.

8.3.5 Reverse Spin Control FR

DRV11873 has an FR pin to set the motor for forward or reverse spin. During DRV11873 power up, FR status is set. During normal operation, the spin direction of the motor does not change if the FR status is changed. The FR status can be reset if the PWM_{IN} is pulled low; if FS is high, PWM must be pulled low for 300 μs, and if FS is low, PWM must be low for 600 μs. After being pulled down for the appropriate time, the FR status resets upon the PWM rising edge.

Feature Description (continued)

8.3.6 5-V LDO

DRV11873 has a built-in 5-V LDO which can output a 20-mA load current. It can provide 5-V bias voltage for external use. TI recommends a 2.2-μF ceramic capacitor to connect closely on the PCB layout between the V5 pin and ground.

8.3.7 Overcurrent Protection

DRV11873 can adjust overcurrent through the external resistor connected to the CS pin and ground. Without using an external current sense resistor, DRV11873 senses the current through the power MOSFET. Therefore, no power loss occurs during the current sensing. This current sense architecture improves the system efficiency. Shorting the CS pin to ground disables overcurrent protection. During overcurrent protection, DRV11873 only limits the current to the motor and it does not shut down the operation. The overcurrent threshold can be set by the value of the external resistor through [Equation 2](#).

$$I \text{ (A)} = \frac{6600}{R_{CS} \text{ (}\Omega\text{)}} \quad (2)$$

During motor start up, the overcurrent level is increased to 1.5 times the value set by R_{CS} . If the overcurrent protection is triggered during the start up sequence, the motor will fail to start.

8.3.8 UVLO

DRV11873 has a built-in UVLO function block. The hysteresis of the UVLO threshold is 200 mV. The device is locked out when V_{CC} reaches 4.1 V and woken up at 4.3 V.

8.3.9 Thermal Shutdown

DRV11873 has a built-in thermal shutdown function, which shuts down the device when the junction temperature is over 160°C and resumes operating when the junction temperature drops back to 150°C.

8.3.10 Anti-Voltage Surge (AVS)

The DRV11873 has a protection feature to prevent any energy from returning to the power supply when the motor is braked. This feature, AVS, protects the device as well as any other device from allowing V_{CC} from increasing. AVS works when the motor is braked to a lower speed and when the motor is stopped.

8.4 Device Functional Modes

8.4.1 Startup

At startup, commutation logic starts to drive the motor with one phase high, one phase low, and the third shut off. If a zero-cross is detected on the shut off phase, commutation logic advances to the next step; the same phase high, the shut off phase goes low, and the low phase is shut off. Initially, the BEMF is not strong enough to detect the zero crossings, at this very initial stage the commutation switches automatically until the BEMF is large enough to read. In startup mode, 100% duty cycle is applied regardless of PWM input. After the commutation logic receives 4 continuous successful zero-crossings, it switches to normal operation.

In certain cases, the motor may have initial speed when the device attempts to startup the motor again. When this occurs, the commutation logic jumps over the startup process and goes to normal operation directly.

8.4.2 Closed Loop Control

After the motor is started successfully, the start up control switches to steady state operation. In steady state control, the motor is commutated 150°. This is an advanced trapezoidal method that allows the device to drive the phases gradually to the maximum current and gradually to 0 at commutation.

Device Functional Modes (continued)

8.4.3 AVS Protection

When the device is commanded to decelerate or stop the motor, in order to protect the IC and the system, the DRV11873 has AVS protection. This function keeps the voltage supply, V_{CC} , from surging above the nominal value. To do this, the device monitors the current flow in the MOSFETs and is able to sense when the surging starts to occur. The AVS function controls the current, not allowing it to charge back to V_{CC} so that there is no voltage surging.

9 Application and Implementation

NOTE

Information in the following applications sections is not part of the TI component specification, and TI does not warrant its accuracy or completeness. TI's customers are responsible for determining suitability of components for their purposes. Customers should validate and test their design implementation to confirm system functionality.

9.1 Application Information

DRV11873 only requires five external components. The device needs a 10- μF or higher ceramic capacitor connected to V_{CC} and ground for decoupling. During layout, the strategy of ground copper pour is very important to enhance the thermal performance. For two or more layers, use eight thermal vias. Refer to [Layout Example](#) for an example of the PCB layout. For high current motors, place three Schottky diodes between phases U, V, W, and ground. Each diode anode terminal must be connected to ground and the cathode terminal must be connected to either U, V, or W. If there is no COM pin on the motor, one can be simulated. Use three resistors connected in a wye formation, one connected to U, one to V, and one to W. Connect the resistor ends opposite of the phases together. This center point is COM. To find the proper resistor value, start with a value of 10 k Ω and continue to decrease by 1 k Ω until the motor runs properly.

9.2 Typical Application

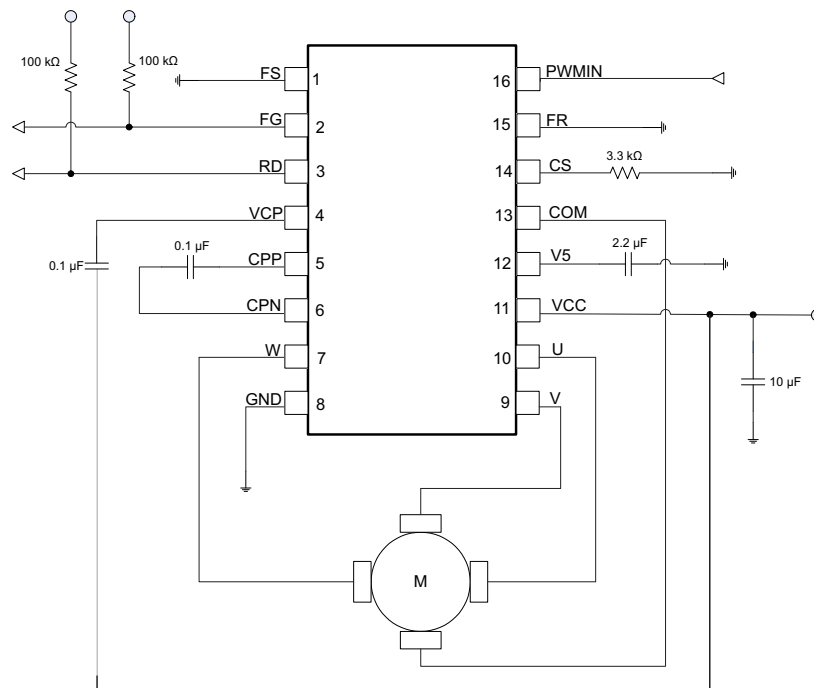

Figure 13. Typical Application Schematic

9.2.1 Design Requirements

Table 1. Design Parameters

		MIN	TYP	MAX	UNIT
Motor voltage		5		16	V
VCC capacitor	Place as close to the pin as possible		10		μF
Operating current	Running with normal load at rated speed			1.5	A
Absolute max current	During startup and locked motor condition			2	A

10 Power Supply Recommendations

The DRV11873 is designed to operate from an input voltage supply, V_{CC} , range between 5 and 16 V. The user must place a 10- μ F ceramic capacitor rated for VCC as close as possible to the VCC and GND pin. If the power supply ripple is more than 200 mV, in addition to the local decoupling capacitors, a bulk capacitance is required and must be sized according to the application requirements. If the bulk capacitance is implemented in the application, the user can reduce the value of the local ceramic capacitor to 1 μ F.

11 Layout

11.1 Layout Guidelines

- Place VCC, GND, U, V, and W pins with thick traces because high current passes through these traces.
- Place the 10- μ F capacitor between VCC and GND, and as close to the VCC and GND pins as possible.
- Place the capacitor between CPP and CPN, and as close to the CPP and CPN pins as possible.
- Place the capacitor between V5 and GND as close to the V5 pin as possible.
- Connect the GND under the thermal pad.
- Keep the thermal pad connection as large as possible, both on the bottom side and top side. It should be one piece of copper without any gaps.

11.2 Layout Example

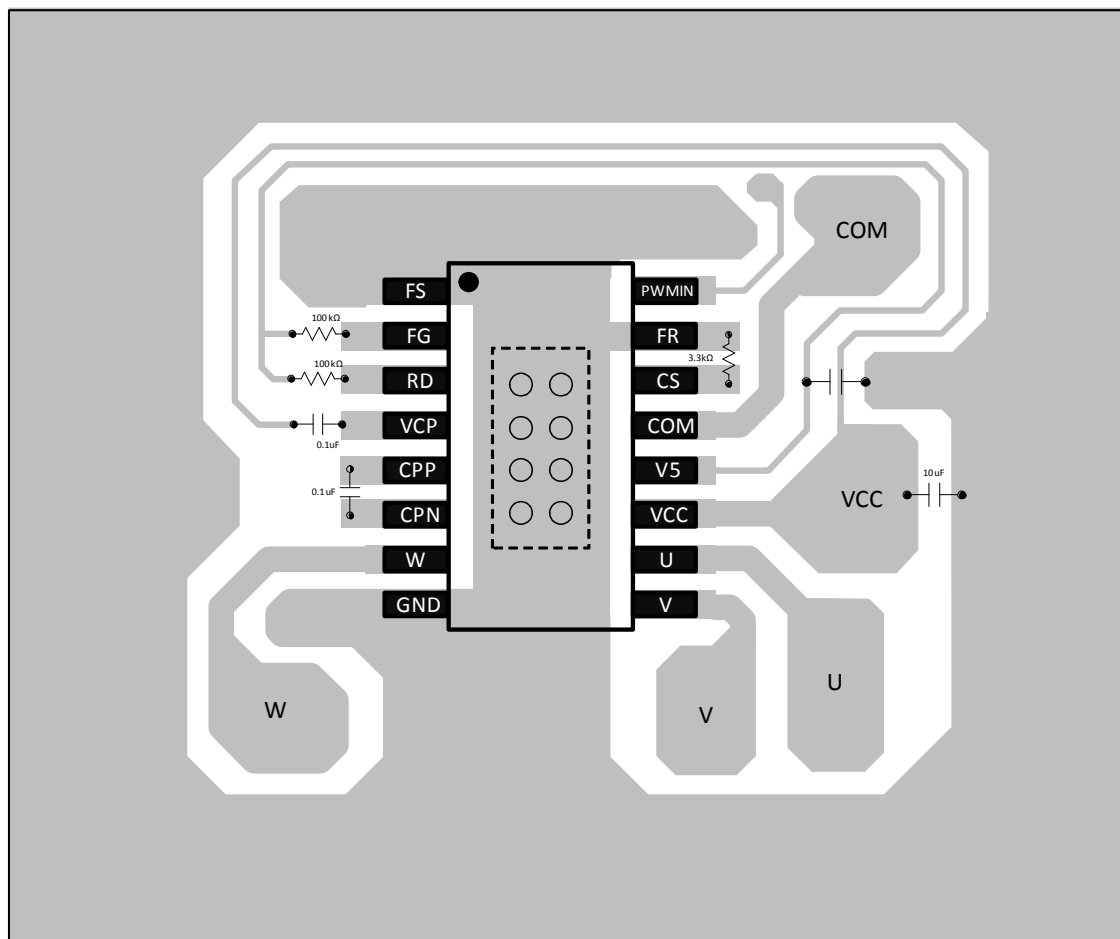

Figure 17. Layout Example Schematic

12 器件和文档支持

12.1 商标

All trademarks are the property of their respective owners.

12.2 静电放电警告



这些装置包含有限的内置 ESD 保护。存储或装卸时，应将导线一起截短或将装置放置于导电泡棉中，以防止 MOS 门极遭受静电损伤。

12.3 术语表

[SLYZ022](#) — TI 术语表。

这份术语表列出并解释术语、首字母缩略词和定义。

13 机械、封装和可订购信息

以下页中包括机械、封装和可订购信息。这些信息是针对指定器件可提供的最新数据。这些数据会在无通知且不对本文档进行修订的情况下发生改变。要获得这份数据表的浏览器版本，请查阅左侧导航栏。

重要声明

德州仪器(TI)及其下属子公司有权根据 JESD46 最新标准,对所提供的产品和服务进行更正、修改、增强、改进或其它更改,并有权根据 JESD48 最新标准中止提供任何产品和服务。客户在下订单前应获取最新的相关信息,并验证这些信息是否完整且是最新的。所有产品的销售都遵循在订单确认时所提供的TI 销售条款与条件。

TI 保证其所销售的组件的性能符合产品销售时 TI 半导体产品销售条件与条款的适用规范。仅在 TI 保证的范围内,且 TI 认为有必要时才会使用测试或其它质量控制技术。除非适用法律做出了硬性规定,否则没有必要对每种组件的所有参数进行测试。

TI 对应用帮助或客户产品设计不承担任何义务。客户应对其使用 TI 组件的产品和应用自行负责。为尽量减小与客户产品和应用相关的风险,客户应提供充分的设计与操作安全措施。

TI 不对任何 TI 专利权、版权、屏蔽作品权或其它与使用了 TI 组件或服务的组合设备、机器或流程相关的 TI 知识产权中授予的直接或隐含权限作出任何保证或解释。TI 所发布的与第三方产品或服务有关的信息,不能构成从 TI 获得使用这些产品或服务的许可、授权、或认可。使用此类信息可能需要获得第三方的专利权或其它知识产权方面的许可,或是 TI 的专利权或其它知识产权方面的许可。

对于 TI 的产品手册或数据表中 TI 信息的重要部分,仅在没有对内容进行任何篡改且带有相关授权、条件、限制和声明的情况下才允许进行复制。TI 对此类篡改过的文件不承担任何责任或义务。复制第三方的信息可能需要服从额外的限制条件。

在转售 TI 组件或服务时,如果对该组件或服务参数的陈述与 TI 标明的参数相比存在差异或虚假成分,则会失去相关 TI 组件或服务的所有明示或暗示授权,且这是不正当的、欺诈性商业行为。TI 对任何此类虚假陈述均不承担任何责任或义务。

客户认可并同意,尽管任何应用相关信息或支持仍可能由 TI 提供,但他们将独立负责满足与其产品及其在应用中使用的 TI 产品相关的所有法律、法规和安全相关要求。客户声明并同意,他们具备制定与实施安全措施所需的全部专业技术和知识,可预见故障的危险后果、监测故障及其后果、降低有可能造成人身伤害的故障的发生机率并采取适当的补救措施。客户将全额赔偿因在此类安全关键应用中使用任何 TI 组件而对 TI 及其代理造成的任何损失。

在某些场合中,为了推进安全相关应用有可能对 TI 组件进行特别的促销。TI 的目标是利用此类组件帮助客户设计和创立其特有的可满足适用的功能安全性标准和要求的终端产品解决方案。尽管如此,此类组件仍然服从这些条款。

TI 组件未获得用于 FDA Class III (或类似的生命攸关医疗设备)的授权许可,除非各方授权官员已经达成了专门管控此类使用的特别协议。

只有那些 TI 特别注明属于军用等级或“增强型塑料”的 TI 组件才是设计或专门用于军事/航空应用或环境的。购买者认可并同意,对并非指定面向军事或航空航天用途的 TI 组件进行军事或航空航天方面的应用,其风险由客户单独承担,并且由客户独立负责满足与此类使用相关的所有法律和法规要求。

TI 已明确指定符合 ISO/TS16949 要求的产品,这些产品主要用于汽车。在任何情况下,因使用非指定产品而无法达到 ISO/TS16949 要求, TI 不承担任何责任。

	产品		应用
数字音频	www.ti.com.cn/audio	通信与电信	www.ti.com.cn/telecom
放大器和线性器件	www.ti.com.cn/amplifiers	计算机及周边	www.ti.com.cn/computer
数据转换器	www.ti.com.cn/dataconverters	消费电子	www.ti.com.cn/consumer-apps
DLP® 产品	www.dlp.com	能源	www.ti.com.cn/energy
DSP - 数字信号处理器	www.ti.com.cn/dsp	工业应用	www.ti.com.cn/industrial
时钟和计时器	www.ti.com.cn/clockandtimers	医疗电子	www.ti.com.cn/medical
接口	www.ti.com.cn/interface	安防应用	www.ti.com.cn/security
逻辑	www.ti.com.cn/logic	汽车电子	www.ti.com.cn/automotive
电源管理	www.ti.com.cn/power	视频和影像	www.ti.com.cn/video
微控制器 (MCU)	www.ti.com.cn/microcontrollers		
RFID 系统	www.ti.com.cn/rfidsys		
OMAP应用处理器	www.ti.com/omap		
无线连通性	www.ti.com.cn/wirelessconnectivity	德州仪器在线技术支持社区	www.deyisupport.com

邮寄地址: 上海市浦东新区世纪大道1568号, 中建大厦32楼邮政编码: 200122
Copyright © 2016, 德州仪器半导体技术(上海)有限公司

PACKAGING INFORMATION

Orderable Device	Status (1)	Package Type	Package Drawing	Pins	Package Qty	Eco Plan (2)	Lead/Ball Finish (6)	MSL Peak Temp (3)	Op Temp (°C)	Device Marking (4/5)	Samples
DRV11873PWPR	ACTIVE	HTSSOP	PWP	16	2000	Green (RoHS & no Sb/Br)	CU NIPDAU	Level-2-260C-1 YEAR	-40 to 85	11873	Samples

(1) The marketing status values are defined as follows:

ACTIVE: Product device recommended for new designs.

LIFEBUY: TI has announced that the device will be discontinued, and a lifetime-buy period is in effect.

NRND: Not recommended for new designs. Device is in production to support existing customers, but TI does not recommend using this part in a new design.

PREVIEW: Device has been announced but is not in production. Samples may or may not be available.

OBSOLETE: TI has discontinued the production of the device.

(2) Eco Plan - The planned eco-friendly classification: Pb-Free (RoHS), Pb-Free (RoHS Exempt), or Green (RoHS & no Sb/Br) - please check <http://www.ti.com/productcontent> for the latest availability information and additional product content details.

TBD: The Pb-Free/Green conversion plan has not been defined.

Pb-Free (RoHS): TI's terms "Lead-Free" or "Pb-Free" mean semiconductor products that are compatible with the current RoHS requirements for all 6 substances, including the requirement that lead not exceed 0.1% by weight in homogeneous materials. Where designed to be soldered at high temperatures, TI Pb-Free products are suitable for use in specified lead-free processes.

Pb-Free (RoHS Exempt): This component has a RoHS exemption for either 1) lead-based flip-chip solder bumps used between the die and package, or 2) lead-based die adhesive used between the die and leadframe. The component is otherwise considered Pb-Free (RoHS compatible) as defined above.

Green (RoHS & no Sb/Br): TI defines "Green" to mean Pb-Free (RoHS compatible), and free of Bromine (Br) and Antimony (Sb) based flame retardants (Br or Sb do not exceed 0.1% by weight in homogeneous material)

(3) MSL, Peak Temp. - The Moisture Sensitivity Level rating according to the JEDEC industry standard classifications, and peak solder temperature.

(4) There may be additional marking, which relates to the logo, the lot trace code information, or the environmental category on the device.

(5) Multiple Device Markings will be inside parentheses. Only one Device Marking contained in parentheses and separated by a "-" will appear on a device. If a line is indented then it is a continuation of the previous line and the two combined represent the entire Device Marking for that device.

(6) Lead/Ball Finish - Orderable Devices may have multiple material finish options. Finish options are separated by a vertical ruled line. Lead/Ball Finish values may wrap to two lines if the finish value exceeds the maximum column width.

Important Information and Disclaimer: The information provided on this page represents TI's knowledge and belief as of the date that it is provided. TI bases its knowledge and belief on information provided by third parties, and makes no representation or warranty as to the accuracy of such information. Efforts are underway to better integrate information from third parties. TI has taken and continues to take reasonable steps to provide representative and accurate information but may not have conducted destructive testing or chemical analysis on incoming materials and chemicals. TI and TI suppliers consider certain information to be proprietary, and thus CAS numbers and other limited information may not be available for release.

In no event shall TI's liability arising out of such information exceed the total purchase price of the TI part(s) at issue in this document sold by TI to Customer on an annual basis.

TAPE AND REEL INFORMATION



QUADRANT ASSIGNMENTS FOR PIN 1 ORIENTATION IN TAPE



*All dimensions are nominal

Device	Package Type	Package Drawing	Pins	SPQ	Reel Diameter (mm)	Reel Width W1 (mm)	A0 (mm)	B0 (mm)	K0 (mm)	P1 (mm)	W (mm)	Pin1 Quadrant
DRV11873PWPR	HTSSOP	PWP	16	2000	330.0	12.4	6.9	5.6	1.6	8.0	12.0	Q1

TAPE AND REEL BOX DIMENSIONS



*All dimensions are nominal

Device	Package Type	Package Drawing	Pins	SPQ	Length (mm)	Width (mm)	Height (mm)
DRV11873PWPR	HTSSOP	PWP	16	2000	367.0	367.0	38.0

PWP (R-PDSO-G16)

PowerPAD™ PLASTIC SMALL OUTLINE

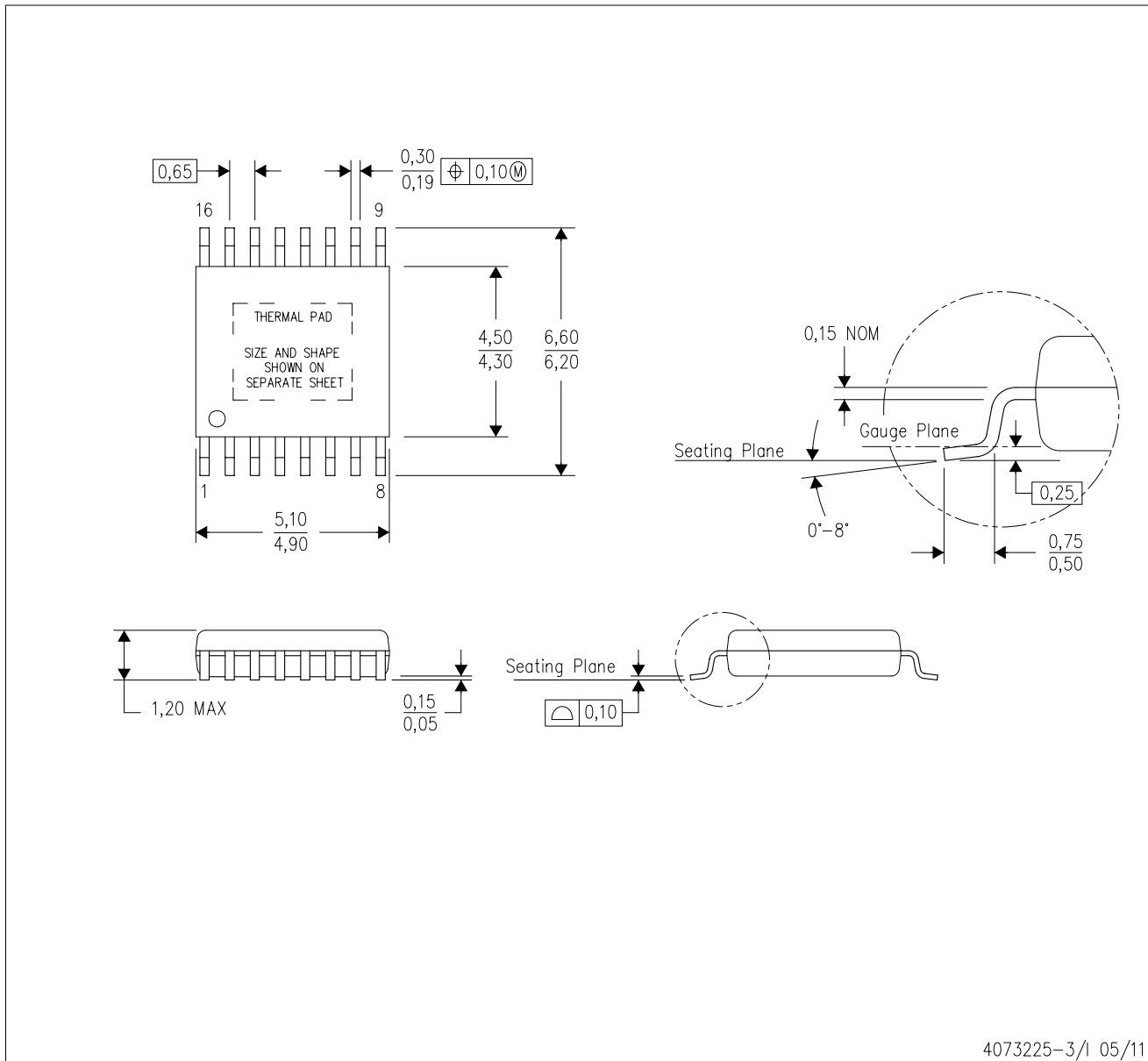

- NOTES:
- A. All linear dimensions are in millimeters.
 - B. This drawing is subject to change without notice.
 - C. Body dimensions do not include mold flash or protrusions. Mold flash and protrusion shall not exceed 0.15 per side.
 - D. This package is designed to be soldered to a thermal pad on the board. Refer to Technical Brief, PowerPad Thermally Enhanced Package, Texas Instruments Literature No. SLMA002 for information regarding recommended board layout. This document is available at www.ti.com <<http://www.ti.com>>.
 - E. See the additional figure in the Product Data Sheet for details regarding the exposed thermal pad features and dimensions.
 - E. Falls within JEDEC MO-153

PowerPAD is a trademark of Texas Instruments.

THERMAL PAD MECHANICAL DATA

PWP (R-PDSO-G16) PowerPAD™ SMALL PLASTIC OUTLINE

THERMAL INFORMATION

This PowerPAD™ package incorporates an exposed thermal pad that is designed to be attached to a printed circuit board (PCB). The thermal pad must be soldered directly to the PCB. After soldering, the PCB can be used as a heatsink. In addition, through the use of thermal vias, the thermal pad can be attached directly to the appropriate copper plane shown in the electrical schematic for the device, or alternatively, can be attached to a special heatsink structure designed into the PCB. This design optimizes the heat transfer from the integrated circuit (IC).

For additional information on the PowerPAD package and how to take advantage of its heat dissipating abilities, refer to Technical Brief, PowerPAD Thermally Enhanced Package, Texas Instruments Literature No. SLMA002 and Application Brief, PowerPAD Made Easy, Texas Instruments Literature No. SLMA004. Both documents are available at www.ti.com.

The exposed thermal pad dimensions for this package are shown in the following illustration.

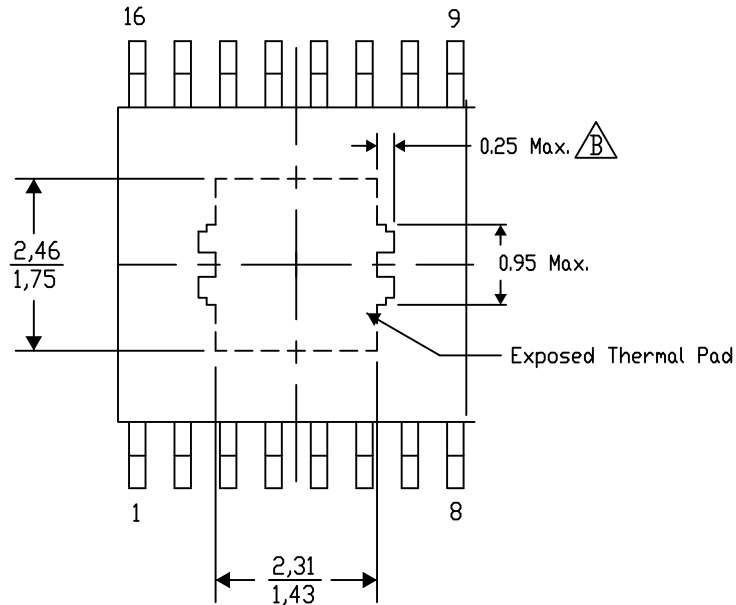

Top View

Exposed Thermal Pad Dimensions

4206332-6/AO 01/16

NOTE: A. All linear dimensions are in millimeters

 Exposed tie strap features may not be present.

PowerPAD is a trademark of Texas Instruments

PWP (R-PDSO-G16)

PowerPAD™ PLASTIC SMALL OUTLINE

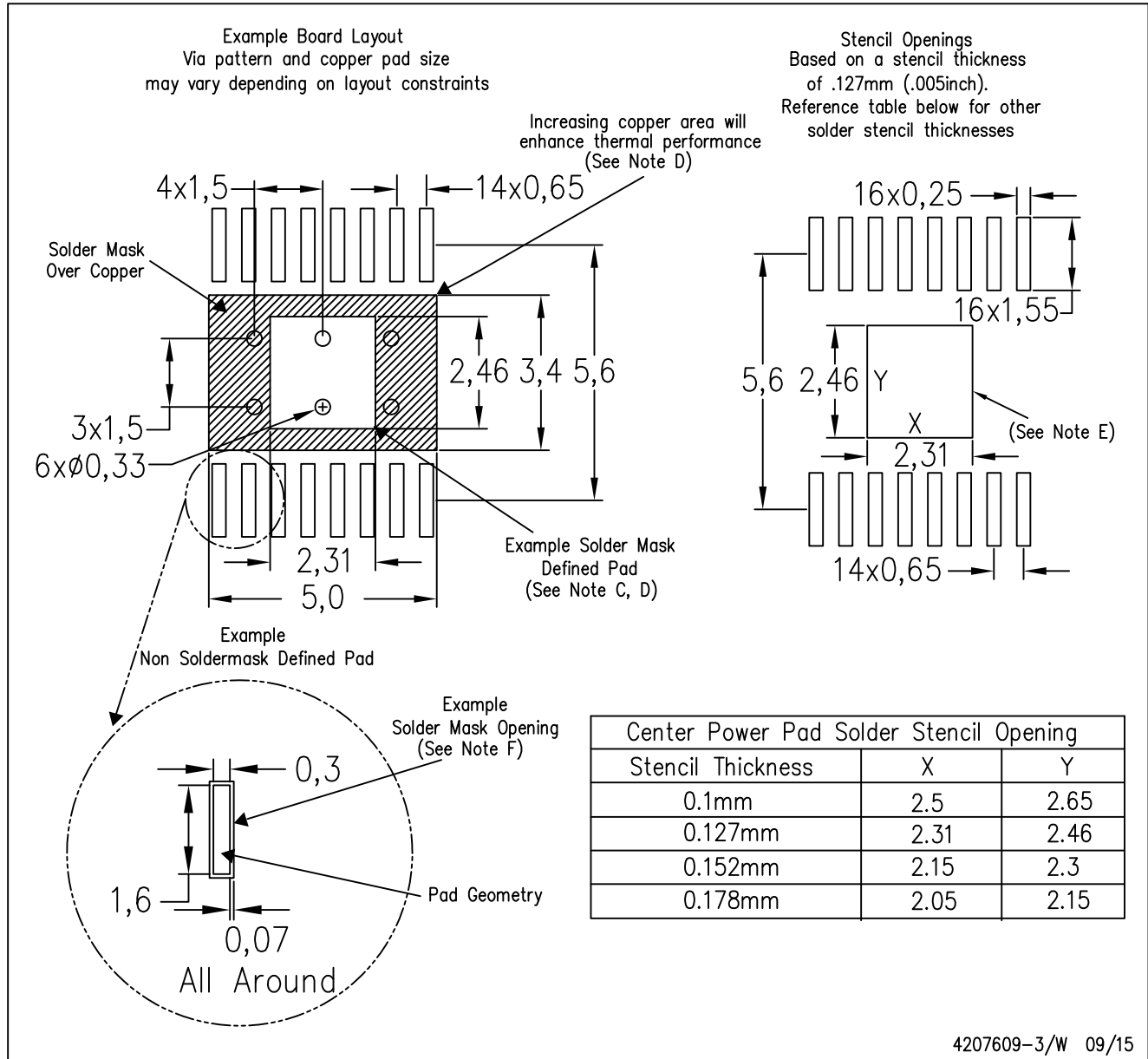

4207609-3/W 09/15

- NOTES:
- A. All linear dimensions are in millimeters.
 - B. This drawing is subject to change without notice.
 - C. Customers should place a note on the circuit board fabrication drawing not to alter the center solder mask defined pad.
 - D. This package is designed to be soldered to a thermal pad on the board. Refer to Technical Brief, PowerPad Thermally Enhanced Package, Texas Instruments Literature No. SLMA002, SLMA004, and also the Product Data Sheets for specific thermal information, via requirements, and recommended board layout. These documents are available at www.ti.com <<http://www.ti.com>>. Publication IPC-7351 is recommended for alternate designs.
 - E. Laser cutting apertures with trapezoidal walls and also rounding corners will offer better paste release. Customers should contact their board assembly site for stencil design recommendations. Example stencil design based on a 50% volumetric metal load solder paste. Refer to IPC-7525 for other stencil recommendations.
 - F. Customers should contact their board fabrication site for solder mask tolerances between and around signal pads.

重要声明

德州仪器(TI) 及其下属子公司有权根据 JESD46 最新标准, 对所提供的产品和服务进行更正、修改、增强、改进或其它更改, 并有权根据 JESD48 最新标准中止提供任何产品和服务。客户在下订单前应获取最新的相关信息, 并验证这些信息是否完整且是最新的。所有产品的销售都遵循在订单确认时所提供的TI 销售条款与条件。

TI 保证其所销售的组件的性能符合产品销售时 TI 半导体产品销售条件与条款的适用规范。仅在 TI 保证的范围内, 且 TI 认为有必要时才会使用测试或其它质量控制技术。除非适用法律做出了硬性规定, 否则没有必要对每种组件的所有参数进行测试。

TI 对应用帮助或客户产品设计不承担任何义务。客户应对其使用 TI 组件的产品和应用自行负责。为尽量减小与客户产品和应用相关的风险, 客户应提供充分的设计与操作安全措施。

TI 不对任何 TI 专利权、版权、屏蔽作品权或其它与使用了 TI 组件或服务的组合设备、机器或流程相关的 TI 知识产权中授予的直接或间接版权限作出任何保证或解释。TI 所发布的与第三方产品或服务有关的信息, 不能构成从 TI 获得使用这些产品或服务的许可、授权、或认可。使用此类信息可能需要获得第三方的专利权或其它知识产权方面的许可, 或是 TI 的专利权或其它知识产权方面的许可。

对于 TI 的产品手册或数据表中 TI 信息的重要部分, 仅在没有对内容进行任何篡改且带有相关授权、条件、限制和声明的情况下才允许进行复制。TI 对此类篡改过的文件不承担任何责任或义务。复制第三方的信息可能需要服从额外的限制条件。

在转售 TI 组件或服务时, 如果对该组件或服务参数的陈述与 TI 标明的参数相比存在差异或虚假成分, 则会失去相关 TI 组件或服务的所有明示或暗示授权, 且这是不正当的、欺诈性商业行为。TI 对任何此类虚假陈述均不承担任何责任或义务。

客户认可并同意, 尽管任何应用相关信息或支持仍可能由 TI 提供, 但他们将独自负责满足与其产品及其应用中使用 TI 产品相关的所有法律、法规和安全相关要求。客户声明并同意, 他们具备制定与实施安全措施所需的全部专业技术和知识, 可预见故障的危险后果、监测故障及其后果、降低有可能造成人身伤害的故障的发生机率并采取适当的补救措施。客户将全额赔偿因在此类安全关键应用中使用任何 TI 组件而对 TI 及其代理造成的任何损失。

在某些场合中, 为了推进安全相关应用有可能对 TI 组件进行特别的促销。TI 的目标是利用此类组件帮助客户设计和创立其特有的可满足适用的功能安全性标准和要求的终端产品解决方案。尽管如此, 此类组件仍然服从这些条款。

TI 组件未获得用于 FDA Class III (或类似的生命攸关医疗设备) 的授权许可, 除非各方授权官员已经达成了专门管控此类使用的特别协议。

只有那些 TI 特别注明属于军用等级或“增强型塑料”的 TI 组件才是设计或专门用于军事/航空应用或环境的。购买者认可并同意, 对并非指定面向军事或航空航天用途的 TI 组件进行军事或航空航天方面的应用, 其风险由客户单独承担, 并且由客户独自负责满足与此类使用相关的所有法律和法规要求。

TI 已明确指定符合 ISO/TS16949 要求的产品, 这些产品主要用于汽车。在任何情况下, 因使用非指定产品而无法达到 ISO/TS16949 要求, TI 不承担任何责任。

	产品		应用
数字音频	www.ti.com.cn/audio	通信与电信	www.ti.com.cn/telecom
放大器和线性器件	www.ti.com.cn/amplifiers	计算机及周边	www.ti.com.cn/computer
数据转换器	www.ti.com.cn/dataconverters	消费电子	www.ti.com.cn/consumer-apps
DLP® 产品	www.dlp.com	能源	www.ti.com.cn/energy
DSP - 数字信号处理器	www.ti.com.cn/dsp	工业应用	www.ti.com.cn/industrial
时钟和计时器	www.ti.com.cn/clockandtimers	医疗电子	www.ti.com.cn/medical
接口	www.ti.com.cn/interface	安防应用	www.ti.com.cn/security
逻辑	www.ti.com.cn/logic	汽车电子	www.ti.com.cn/automotive
电源管理	www.ti.com.cn/power	视频和影像	www.ti.com.cn/video
微控制器 (MCU)	www.ti.com.cn/microcontrollers		
RFID 系统	www.ti.com.cn/rfidsys		
OMAP应用处理器	www.ti.com.cn/omap		
无线连通性	www.ti.com.cn/wirelessconnectivity	德州仪器在线技术支持社区	www.deyisupport.com

Mailing Address: Texas Instruments, Post Office Box 655303, Dallas, Texas 75265
Copyright © 2016, Texas Instruments Incorporated