



UML2502

Power MOSFET

N-CHANNEL POWER MOSFET

DESCRIPTION

The **UML2502** uses advanced trench technology to provide excellent $R_{DS(ON)}$, low gate charge and operation with low gate voltages. This device is suitable for use as a load switch or in PWM applications.

FEATURES

- * $R_{DS(ON)} < 45m\Omega @ V_{GS} = 4.5V$
- * $R_{DS(ON)} < 80m\Omega @ V_{GS} = 2.5V$
- * Ultra Low Gate Charge (Max. 12nC)
- * Low Reverse Transfer Capacitance ($C_{RSS} = \text{Typical } 66pF$)
- * Fast Switching Capability
- * Avalanche Energy Specified
- * Improved dv/dt Capability

SYMBOL

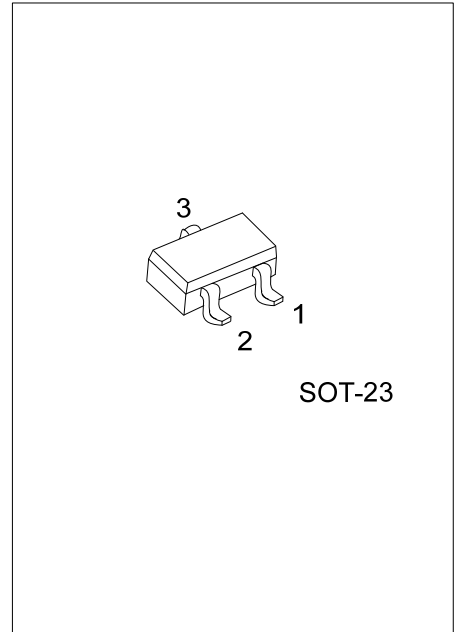
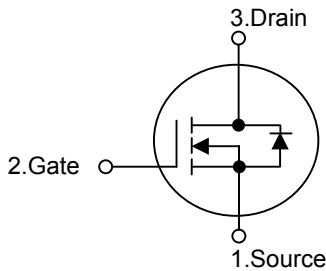

ORDERING INFORMATION

Ordering Number		Package	Pin Assignment			Packing
Lead Free Plating	Halogen Free		1	2	3	
UML2502L-AE3-R	UML2502G-AE3-R	SOT-23	S	G	D	Tape Reel

<p>UML2502L-AE3-R</p> <p>(1)Packing Type</p> <p>(2)Package Type</p> <p>(3)Lead Plating</p>	<p>(1) R: Tape Reel</p> <p>(2) AE3: SOT-23</p> <p>(3) L: Lead Free Plating, G: Halogen Free</p>
--	---

MARKING

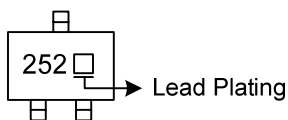

■ ABSOLUTE MAXIMUM RATINGS ($T_A = 25^\circ\text{C}$, unless otherwise specified)

PARAMETER	SYMBOL	RATINGS	UNIT
Drain-Source Voltage	V_{DSS}	20	V
Gate-Source Voltage	V_{GSS}	± 12	V
Continuous Drain Current $V_{GS}=4.5\text{V}$	I_D	4.2	A
Pulsed Drain Current (Note 2)	I_{DM}	33	A
Maximum Power Dissipation	P_D	1.25	W
Linear Derating Factor		0.01	W/ $^\circ\text{C}$
Junction Temperature	T_J	+150	$^\circ\text{C}$
Storage Temperature	T_{STG}	-55 ~ +150	$^\circ\text{C}$

Note: 1. Absolute maximum ratings are those values beyond which the device could be permanently damaged.

Absolute maximum ratings are stress ratings only and functional device operation is not implied.

2. Pulse width limited by $T_{J(MAX)}$

■ THERMAL DATA

PARAMETER	SYMBOL	RATINGS	UNIT
Junction to Ambient	θ_{JA}	75 ~ 100	$^\circ\text{C}/\text{W}$

■ ELECTRICAL CHARACTERISTICS ($T_J = 25^\circ\text{C}$, unless otherwise specified)

PARAMETER	SYMBOL	TEST CONDITIONS	MIN	TYP	MAX	UNIT
OFF CHARACTERISTICS						
Drain-Source Breakdown Voltage	BV_{DSS}	$V_{GS}=0\text{V}, I_D=250\mu\text{A}$	20			V
Drain-Source Leakage Current	I_{DSS}	$V_{GS}=0\text{V}, V_{DS}=16\text{V}$			1.0	μA
Gate-Source Leakage Current	I_{GSS}	$V_{GS}=\pm 12\text{V}, V_{DS}=0\text{V}$			± 100	nA
Breakdown Voltage Temperature Coefficient	$\Delta BV_{DSS}/\Delta T_J$	Reference to $25^\circ\text{C}, I_D=1\text{mA}$		0.01		V/ $^\circ\text{C}$
ON CHARACTERISTICS						
Gate Threshold Voltage	$V_{GS(TH)}$	$V_{DS}=V_{GS}, I_D=250\mu\text{A}$	0.6		1.2	V
Drain-Source On-State Resistance (Note)	$R_{DS(ON)}$	$V_{GS}=4.5\text{V}, I_D=4.2\text{A}$		35	45	m Ω
		$V_{GS}=2.5\text{V}, I_D=3.6\text{A}$		50	80	
DYNAMIC CHARACTERISTICS						
Input Capacitance	C_{ISS}	$V_{GS}=0\text{V}, V_{DS}=15\text{V}, f=1.0\text{MHz}$		740		pF
Output Capacitance	C_{OSS}			90		pF
Reverse Transfer Capacitance	C_{RSS}			66		pF
SWITCHING PARAMETERS						
Turn-ON Delay Time (Note)	$t_{D(ON)}$	$V_{DS}=10\text{V}, R_G=6\Omega, R_D=10\Omega, I_D=1.0\text{A}$		7.5		ns
Turn-ON Rise Time	t_R			10		ns
Turn-OFF Delay Time	$t_{D(OFF)}$			54		ns
Turn-OFF Fall-Time	t_F			26		ns
Total Gate Charge (Note)	Q_G	$V_{GS}=5.0\text{V}, V_{DS}=10\text{V}, I_D=4.0\text{A}$		8.0	12	nC
Gate Source Charge	Q_{GS}			1.8	2.7	nC
Gate Drain Charge	Q_{GD}			1.7	2.6	nC
SOURCE- DRAIN DIODE RATINGS AND CHARACTERISTICS						
Diode Forward Voltage	V_{SD}	$V_{GS}=0\text{V}, I_S=1.3\text{A}, T_J=25^\circ\text{C}$ (Note)			1.2	V
Maximum Pulsed Drain-Source Diode Forward Current	I_{SM}				33	A
Maximum Continuous Drain-Source Diode Forward Current	I_S				1.3	A
Reverse Recovery Time	t_{RR}	$I_F=1.3\text{A}, dI/dt=100\text{A}/\mu\text{s}, T_J=25^\circ\text{C}$ (Note)		16	24	ns
Reverse Recovery Charge	Q_{RR}			8.6	13	nC

Notes: Pulse width $\leq 300\mu\text{s}$; duty cycle $\leq 2\%$.

TYPICAL CHARACTERISTICS

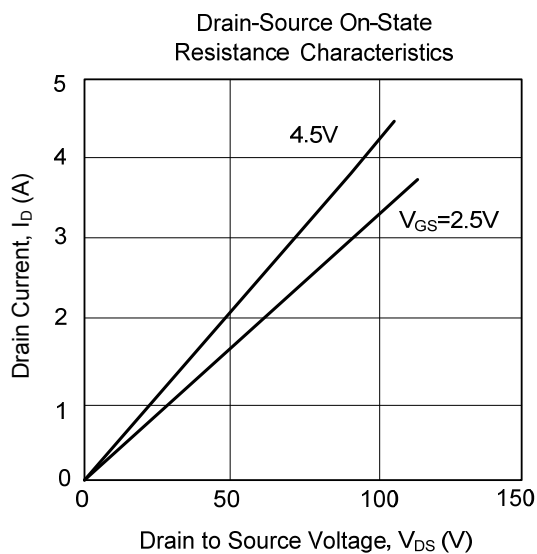
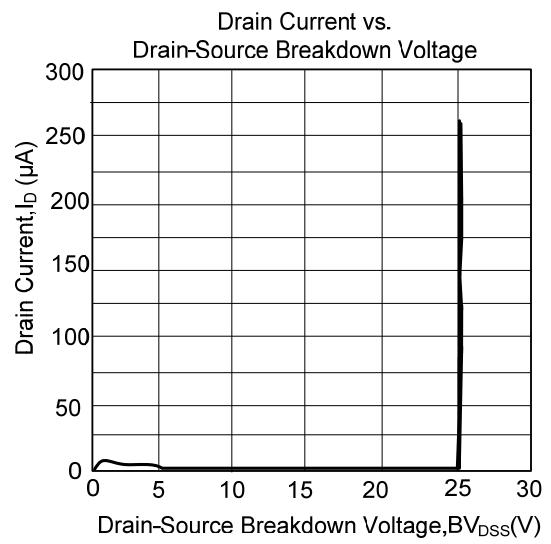
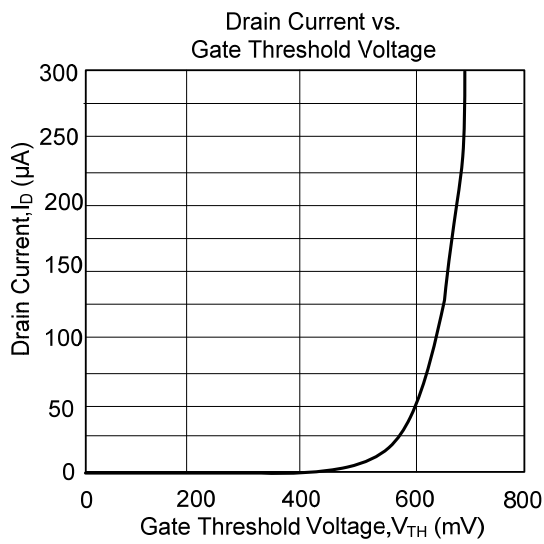
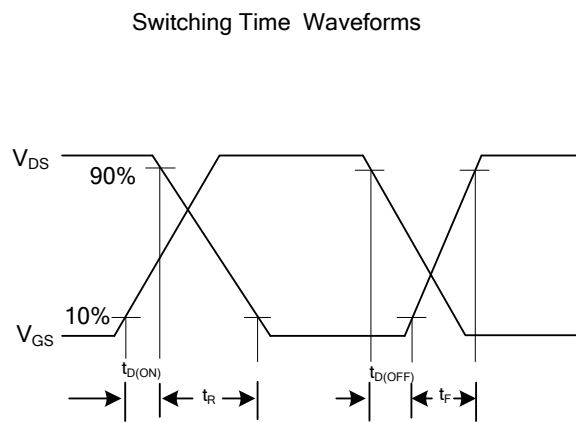
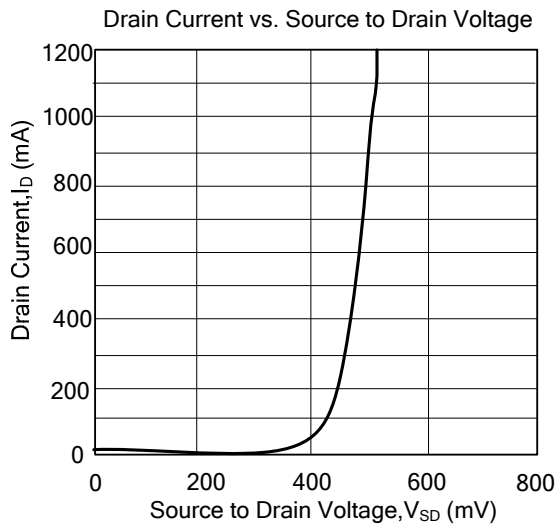

UTC assumes no responsibility for equipment failures that result from using products at values that exceed, even momentarily, rated values (such as maximum ratings, operating condition ranges, or other parameters) listed in products specifications of any and all UTC products described or contained herein. UTC products are not designed for use in life support appliances, devices or systems where malfunction of these products can be reasonably expected to result in personal injury. Reproduction in whole or in part is prohibited without the prior written consent of the copyright owner. The information presented in this document does not form part of any quotation or contract, is believed to be accurate and reliable and may be changed without notice.