

215 Series, 5x20 mm, Time-Lag Fuse



Agency Approvals

Agency	Agency File Number	Ampere Range
	Cartridge: NBK080205-E10480A NBK250702-E10480E NBK100408-JP1021A	1A – 5A 6.3A – 15A 16A – 20A
	Leaded: NBK080205-E10480B NBK250702-E10480F NBK100408-JP1021B	1A – 5A 6.3A – 15A 16A – 20A
	2005010207145714	1A – 6.3A
	CQC07012021808	8A – 10A
	SU05001-2011B	1A – 2.5A
	SU05001-10001	3.15A – 6.3A
	SU05001-10002	8A
	SU05001-2012B	4A – 10A
	E10480	0.125A - 20A
	29862	0.5A – 12A
	1517218	0.125A-12A
		15A*, 16A*, 20A*
	40013521	0.2A – 8A *10A
	40016610	*12A
	KM41462	0.200A – 10A
	J50258578	16A/20A
	N/A	0.125A – 20A

* Approved for cartridge versions only

Description

5x20mm Time-Lag surge withstand ceramic body cartridge fuse designed to IEC specification

Features

- Designed to International (IEC) Standards for use globally
- High breaking capacity
- Meets the IEC 60127-2, Sheet 5 specification for Time-Lag fuses
- RoHS compliant and lead-free

Applications

Used as supplementary protection in appliance or utilization equipment to provide individual protection for components or internal circuits.

Additional Information



Datasheet



Resources



Samples

Electrical Characteristics for Series

% of Ampere Rating	Ampere Rating	Opening Time
150%	0.125A – 0.800A	60 minutes, Minimum
	1A – 3.15A	60 minutes, Minimum
	4A – 6.3A	60 minutes, Minimum
	8A – 20A	30 minutes, Minimum
210%	0.125A – 0.800A	30 minutes, Maximum
	1A – 3.15A	30 minutes, Maximum
	4A – 6.3A	30 minutes, Maximum
	8A – 20A	30 minutes, Maximum
275%	0.125A – 0.800A	.25 sec. Min.; 80 secs. Max.
	1A – 3.15A	.75 sec. Min.; 80 secs. Max.
	4A – 6.3A	.75 sec. Min.; 80 secs. Max.
	8A – 20A	.75 sec. Min.; 80 secs. Max.
400%	0.125A – 0.800A	.05 sec., Min.; 5 secs. Max.
	1A – 3.15A	.095 sec., Min.; 5 secs. Max.
	4A – 6.3A	.150 sec., Min.; 5 secs. Max.
	8A – 20A	.150 sec., Min.; 5 secs. Max.
1000%	0.125A – 0.800A	.005 sec., Min.; .150 sec. Max.
	1A – 3.15A	.010 sec., Min.; .150 sec. Max.
	4A – 6.3A	.010 sec., Min.; .150 sec. Max.
	8A – 20A	.010 sec., Min.; .150 sec. Max.

Average Time Current Curves

T-C Curves for 125mA to 800mA only

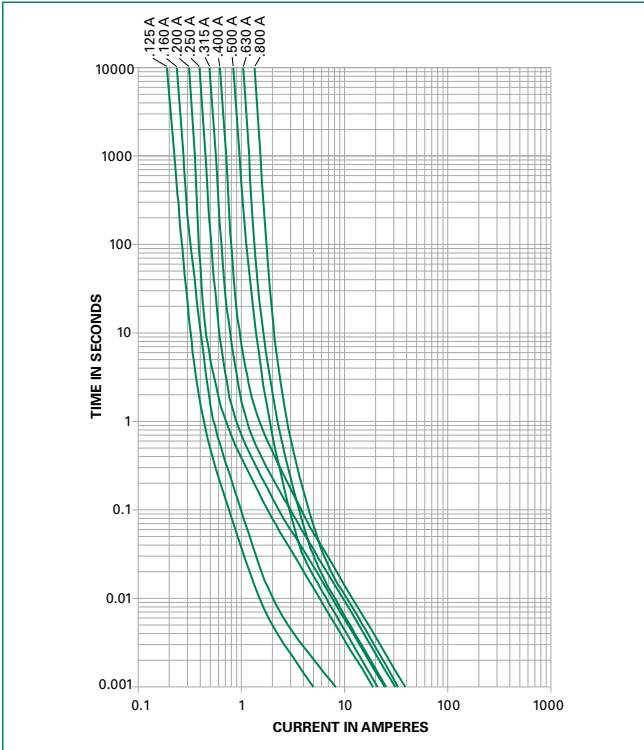

T-C Curves for 1A to 20A only

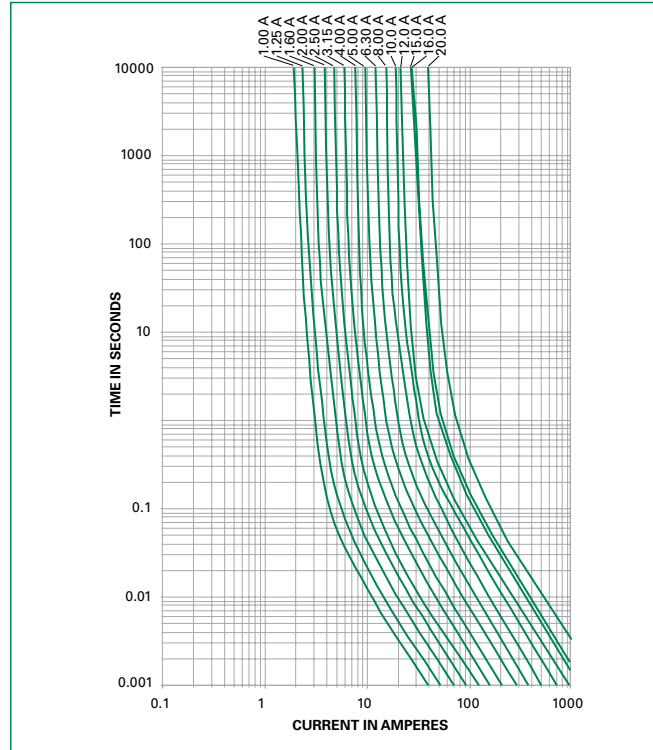

Soldering Parameters - Wave Soldering

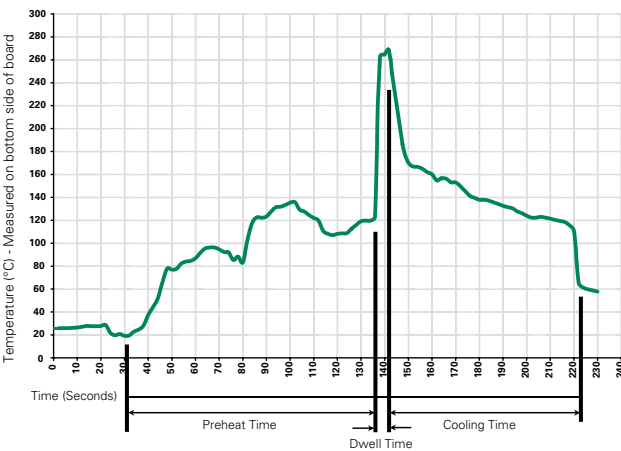

Recommended Process Parameters:

Wave Parameter	Lead-Free Recommendation
Preheat: (Depends on Flux Activation Temperature) (Typical Industry Recommendation)	
Temperature Minimum:	100° C
Temperature Maximum:	150° C
Preheat Time:	60-180 seconds
Solder Pot Temperature:	260° C Maximum
Solder Dwell Time:	2-5 seconds

Recommended Hand-Solder Parameters:

Solder Iron Temperature: 350° C +/- 5° C
Heating Time: 5 seconds max.

Note: These devices are not recommended for IR or Convection Reflow process.

Different values of A and B available, please contact the Littelfuse sales representative in your region:

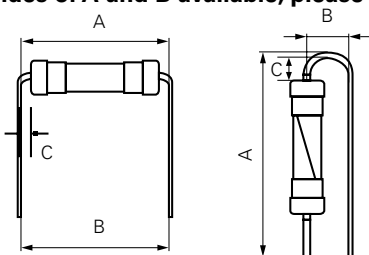

For the pigtailed fuse, please follow the recommendations below for axial lead forming and mounting into PCB:

Lead forming:

The distance C between cap flat surface and axial lead shall be greater than 1.0 mm.

PCB mounting:

The distance between PCB and fuse cap is recommended to be a minimum of 1.5 mm.

Axial Lead & Cartridge Fuses

5x20 mm > Time-Lag > 215 Series

Dimensions

All dimensions in mm

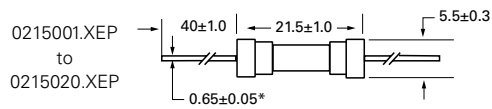
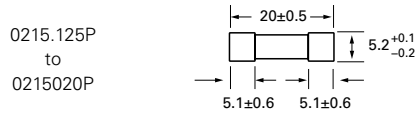

Notes:

- * Ratings above 6.3 A have 0.8 ± 0.05 diameter lead;
- * Ratings above 12 A have 1.2 ± 0.05 diameter lead.

Part Numbering System

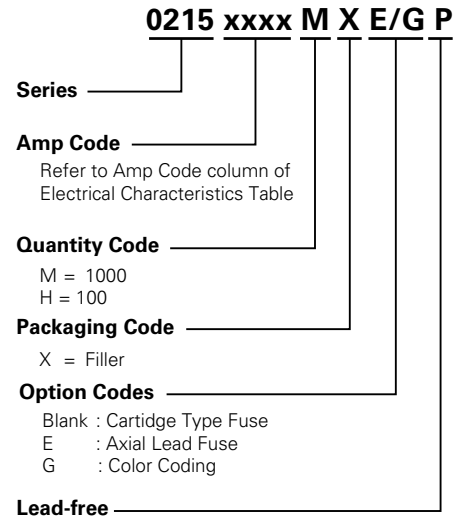

Packaging

Packaging Option	Packaging Specification	Quantity	Quantity & Packaging Code	Taping Width
215 Series				
Bulk	N/A	1000	MX	N/A
Bulk	N/A	1000	MXE	N/A
Reel and Tape	N/A	1000	MRET1	T1=53mm (2.087")
Bulk and Color Coding	N/A	1000	MXG	N/A
Bulk	N/A	1000	MXB	N/A
Bulk	N/A	100	HX	N/A