



+5V供电、多通道RS-232 驱动器/接收器

概述

MAX220–MAX249系列线驱动器/接收器，专为EIA/TIA-232E以及V.28/V.24通信接口设计，尤其是无法提供±12V电源的应用。

这些器件特别适合电池供电系统，这是由于其低功耗关断模式可以将功耗减小到5μW以内。MAX225、MAX233、MAX235以及MAX245/MAX246/MAX247不需要外部元件，推荐用于印刷电路板面积有限的应用。

应用

便携式计算机
低功耗调制解调器
接口转换
电池供电RS-232系统
多点RS-232网络

AutoShutdown和UCSP是Maxim Integrated Products, Inc.的商标。

新一代器件特性

- ◆ 对于低电压、集成ESD保护的应用
MAX3222E/MAX3232E/MAX3237E/MAX3241E/
MAX3246E: +3.0V至+5.5V、低功耗、速率高达
1Mbps、利用四个0.1μF电容实现真正的
RS-232收发器(MAX3246E提供UCSP™封装)
- ◆ 对于低成本应用
MAX221E: ±15kV ESD保护、+5V、1μA、
具有AutoShutdown™功能的单芯片RS-232收发器

订购信息

PART	TEMP RANGE	PIN-PACKAGE
MAX220CPE+	0°C to +70°C	16 Plastic DIP
MAX220CSE+	0°C to +70°C	16 Narrow SO
MAX220CWE+	0°C to +70°C	16 Wide SO
MAX220C/D	0°C to +70°C	Dice*
MAX220EPE+	-40°C to +85°C	16 Plastic DIP
MAX220ESE+	-40°C to +85°C	16 Narrow SO
MAX220EWE+	-40°C to +85°C	16 Wide SO
MAX220EJE	-40°C to +85°C	16 CERDIP
MAX220MJE	-55°C to +125°C	16 CERDIP

+表示无铅(Pb)/符合RoHS标准的封装。

*裸片规格，请与工厂联系。

订购信息(续)在数据资料的最后给出。

选型表

Part Number	Power Supply (V)	No. of RS-232 Drivers/Rx	No. of Ext. Caps	Nominal Cap. Value (μF)	SHDN & Three-State	Rx Active in SHDN	Data Rate (kbps)	Features
MAX220	+5	2/2	4	0.047/0.33	No	—	120	Ultra-low-power, industry-standard pinout
MAX222	+5	2/2	4	0.1	Yes	—	200	Low-power shutdown
MAX223 (MAX213)	+5	4/5	4	1.0 (0.1)	Yes	✓	120	MAX241 and receivers active in shutdown
MAX225	+5	5/5	0	—	Yes	✓	120	Available in SO
MAX230 (MAX200)	+5	5/0	4	1.0 (0.1)	Yes	—	120	5 drivers with shutdown
MAX231 (MAX201)	+5 and +7.5 to +13.2	2/2	2	1.0 (0.1)	No	—	120	Standard +5/+12V or battery supplies; same functions as MAX232
MAX232 (MAX202)	+5	2/2	4	1.0 (0.1)	No	—	120 (64)	Industry standard
MAX232A	+5	2/2	4	0.1	No	—	200	Higher slew rate, small caps
MAX233 (MAX203)	+5	2/2	0	—	No	—	120	No external caps
MAX233A	+5	2/2	0	—	No	—	200	No external caps, high slew rate
MAX234 (MAX204)	+5	4/0	4	1.0 (0.1)	No	—	120	Replaces 1488
MAX235 (MAX205)	+5	5/5	0	—	Yes	—	120	No external caps
MAX236 (MAX206)	+5	4/3	4	1.0 (0.1)	Yes	—	120	Shutdown, three state
MAX237 (MAX207)	+5	5/3	4	1.0 (0.1)	No	—	120	Complements IBM PC serial port
MAX238 (MAX208)	+5	4/4	4	1.0 (0.1)	No	—	120	Replaces 1488 and 1489
MAX239 (MAX209)	+5 and +7.5 to +13.2	3/5	2	1.0 (0.1)	No	—	120	Standard +5/+12V or battery supplies; single-package solution for IBM PC serial port
MAX240	+5	5/5	4	1.0	Yes	—	120	DIP or flatpack package
MAX241 (MAX211)	+5	4/5	4	1.0 (0.1)	Yes	—	120	Complete IBM PC serial port
MAX242	+5	2/2	4	0.1	Yes	✓	200	Separate shutdown and enable
MAX243	+5	2/2	4	0.1	No	—	200	Open-line detection simplifies cabling
MAX244	+5	8/10	4	1.0	No	—	120	High slew rate
MAX245	+5	8/10	0	—	Yes	✓	120	High slew rate, int. caps, two shutdown modes
MAX246	+5	8/10	0	—	Yes	✓	120	High slew rate, int. caps, three shutdown modes
MAX247	+5	8/9	0	—	Yes	✓	120	High slew rate, int. caps, nine operating modes
MAX248	+5	8/8	4	1.0	Yes	✓	120	High slew rate, selective half-chip enables
MAX249	+5	6/10	4	1.0	Yes	✓	120	Available in quad flatpack package



本文是英文数据资料的译文，文中可能存在翻译上的不准确或错误。如需进一步确认，请在您的设计中参考英文资料。

有关价格、供货及订购信息，请联络Maxim亚洲销售中心：10800 852 1249 (北中国区)，10800 152 1249 (南中国区)，或访问Maxim的中文网站：china.maxim-ic.com。

+5V供电、多通道RS-232 驱动器/接收器

ABSOLUTE MAXIMUM RATINGS—MAX220/222/232A/233A/242/243

(Voltages referenced to GND.)		16-Pin Narrow SO (derate 8.70mW/°C above +70°C) ...696mW
V _{CC}	-0.3V to +6V	16-Pin Wide SO (derate 9.52mW/°C above +70°C).....762mW
V ₊ (Note 1).....	(V _{CC} - 0.3V) to +14V	18-Pin Wide SO (derate 9.52mW/°C above +70°C).....762mW
V ₋ (Note 1).....	+0.3V to -14V	20-Pin Wide SO (derate 10.00mW/°C above +70°C)....800mW
Input Voltages		20-Pin SSOP (derate 8.00mW/°C above +70°C)640mW
T _{IN}	-0.3V to (V _{CC} - 0.3V)	16-Pin CERDIP (derate 10.00mW/°C above +70°C).....800mW
R _{IN} (Except MAX220).....	±30V	18-Pin CERDIP (derate 10.53mW/°C above +70°C)....842mW
R _{IN} (MAX220).....	±25V	Operating Temperature Ranges
T _{OUT} (Except MAX220) (Note 2).....	±15V	MAX2_AC_, MAX2_C_.....
T _{OUT} (MAX220).....	±13.2V	MAX2_AE_, MAX2_E_.....
Output Voltages		MAX2_AM_, MAX2_M_.....
T _{OUT}	±15V	Storage Temperature Range.....
R _{OUT}	-0.3V to (V _{CC} + 0.3V)	Lead Temperature (soldering, 10s).....
Driver/Receiver Output Short Circuited to GND.....	Continuous	Soldering Temperature (reflow)
Continuous Power Dissipation (T _A = +70°C)		20 PDIP (P20M+1).....
16-Pin Plastic DIP (derate 10.53mW/°C above +70°C) ..842mW		All other lead(Pb)-free packages.....
18-Pin Plastic DIP (derate 11.11mW/°C above +70°C) ..889mW		All other packages containing lead(Pb).....
20-Pin Plastic DIP (derate 8.00mW/°C above +70°C) ..440mW		

Note 1: For the MAX220, V₊ and V₋ can have a maximum magnitude of 7V, but their absolute difference cannot exceed 13V.

Note 2: Input voltage measured with T_{OUT} in high-impedance state, V_{SHDN} or V_{CC} = 0V.

Stresses beyond those listed under "Absolute Maximum Ratings" may cause permanent damage to the device. These are stress ratings only, and functional operation of the device at these or any other conditions beyond those indicated in the operational sections of the specifications is not implied. Exposure to absolute maximum rating conditions for extended periods may affect device reliability.

ELECTRICAL CHARACTERISTICS—MAX220/222/232A/233A/242/243

(V_{CC} = +5V ±10%, C1-C4 = 0.1µF, MAX220, C1 = 0.047µF, C2-C4 = 0.33µF, T_A = T_{MIN} to T_{MAX}, unless otherwise noted.) (Note 3)

PARAMETER	CONDITIONS	MIN	TYP	MAX	UNITS	
RS-232 TRANSMITTERS						
Output Voltage Swing	All transmitter outputs loaded with 3kΩ to GND	±5	±8		V	
Input Logic-Low Voltage			1.4	0.8	V	
Input Logic-High Voltage	All devices except MAX220	2	1.4		V	
	MAX220: V _{CC} = +5.0V	2.4				
Logic Pullup/Input Current	All except MAX220, normal operation		5	40	µA	
	V _{SHDN} = 0V, MAX222/MAX242, shutdown, MAX220		±0.01	±1		
Output Leakage Current	V _{CC} = +5.5V, V _{SHDN} = 0V, V _{OUT} = ±15V, MAX222/MAX242		±0.01	±10	µA	
	V _{CC} = V _{SHDN} = 0V	V _{OUT} = ±15V		±10		
		MAX220, V _{OUT} = ±12V				±25
Data Rate			200	116	kbps	
Transmitter Output Resistance	V _{CC} = V ₊ = V ₋ = 0V, V _{OUT} = ±2V	300	10M		Ω	
Output Short-Circuit Current	V _{OUT} = 0V	V _{OUT} = 0V	±7	±22	mA	
		MAX220				±60
RS-232 RECEIVERS						
RS-232 Input Voltage Operating Range				±30	V	
	MAX220			±25		
RS-232 Input Threshold Low	V _{CC} = +5V	All except MAX243 R2IN	0.8	1.3	V	
		MAX243 R2IN (Note 4)	-3			
RS-232 Input Threshold High	V _{CC} = +5V	All except MAX243 R2IN		1.8	2.4	V
		MAX243 R2IN (Note 4)	-0.5	-0.1		

+5V供电、多通道RS-232 驱动器/接收器

MAX220-MAX249

ELECTRICAL CHARACTERISTICS—MAX220/222/232A/233A/242/243 (continued)

(V_{CC} = +5V ±10%, C₁–C₄ = 0.1μF, MAX220, C₁ = 0.047μF, C₂–C₄ = 0.33μF, T_A = T_{MIN} to T_{MAX}, unless otherwise noted.) (Note 3)

PARAMETER	CONDITIONS		MIN	TYP	MAX	UNITS
RS-232 Input Hysteresis	All except MAX220/MAX243, V _{CC} = +5V, no hysteresis in shutdown		0.2	0.5	1.0	V
	MAX220		0.3			
	MAX243		1			
RS-232 Input Resistance	T _A = +25°C (MAX220)		3	5	7	kΩ
			3	5	7	
TTL/CMOS Output Voltage Low	I _{OUT} = 3.2mA		0.2		0.4	V
	I _{OUT} = 1.6mA (MAX220)		0.4			
TTL/CMOS Output Voltage High	I _{OUT} = -1.0mA		3.5	V _{CC} - 0.2		V
TTL/CMOS Output Short-Circuit Current	Sourcing V _{OUT} = V _{GND}		-2	-10		mA
	Sinking V _{OUT} = V _{CC}		10	30		
TTL/CMOS Output Leakage Current	V _{SHDN} = V _{CC} or V _{EN} = V _{CC} (V _{SHDN} = 0V for MAX222), 0V ≤ V _{OUT} ≤ V _{CC}		±0.05		±10	μA
EN Input Threshold Low	MAX242		1.4		0.8	V
EN Input Threshold High	MAX242		2.0	1.4		V
Supply Voltage Range			4.5	5.5		V
V _{CC} Supply Current (V _{SHDN} = V _{CC}), Figures 5, 6, 11, 19	No load	MAX220	0.5		2	mA
		MAX222/MAX232A/MAX233A/ MAX242/MAX243	4		10	
	3kΩ load both inputs	MAX220	12			
		MAX222/MAX232A/MAX233A/ MAX242/MAX243	15			
Shutdown Supply Current	MAX222/ MAX242	T _A = +25°C	0.1		10	μA
		T _A = 0°C to +70°C	2		50	
		T _A = -40°C to +85°C	2		50	
		T _A = -55°C to +125°C	35		100	
SHDN Input Leakage Current	MAX222/MAX242				±1	μA
SHDN Threshold Low	MAX222/MAX242		1.4		0.8	V
SHDN Threshold High	MAX222/MAX242		2.0	1.4		V
Transition Slew Rate	C _L = 50pF to 2500pF, R _L = 3kΩ to 7kΩ, V _{CC} = +5V, T _A = +25°C, measured from +3V to -3V or -3V to +3V	MAX222/MAX232A/ MAX233/MAX242/MAX243	6	12	30	V/μs
		MAX220	1.5	3	30.0	
Transmitter Propagation Delay TLL to RS-232 (Normal Operation)	t _{PHLT} , Figure 1	MAX222/MAX232A/ MAX233/MAX242/MAX243	1.3		3.5	μs
		MAX220	4		10	
	t _{PLHT} , Figure 1	MAX222/MAX232A/ MAX233/MAX242/MAX243	1.5		3.5	
		MAX220	5		10	

+5V供电、多通道RS-232 驱动器/接收器

ELECTRICAL CHARACTERISTICS—MAX220/222/232A/233A/242/243 (continued)

(V_{CC} = +5V ±10%, C1–C4 = 0.1μF, MAX220, C1 = 0.047μF, C2–C4 = 0.33μF, T_A = T_{MIN} to T_{MAX}, unless otherwise noted.) (Note 3)

PARAMETER	CONDITIONS		MIN	TYP	MAX	UNITS
Receiver Propagation Delay RS-232 to TLL (Normal Operation)	t _{PHLR} , Figure 2	MAX222/MAX232A/MAX233/ MAX242/MAX243		0.5	1	μs
		MAX220		0.6	3	
	t _{PLHR} , Figure 2	MAX222/MAX232A/MAX233/ MAX242/MAX243		0.6	1	
		MAX220		0.8	3	
Receiver Propagation Delay RS-232 to TLL (Shutdown)	t _{PHLS} , Figure 2	MAX242		0.5	10	μs
	t _{PHLS} , Figure 2	MAX242		2.5	10	
Receiver-Output Enable Time	t _{ER}	MAX242, Figure 3		125	500	ns
Receiver-Output Disable Time	t _{DR}	MAX242, Figure 3		160	500	ns
Transmitter-Output Enable Time (S _{HDN} Goes High)	t _{ET}	MAX222/MAX242, 0.1μF caps (includes charge-pump start-up), Figure 4		250		μs
Transmitter-Output Disable Time (S _{HDN} Goes Low)	t _{DT}	MAX222/MAX242, 0.1μF caps, Figure 4		600		ns
Transmitter + to - Propagation Delay Difference (Normal Operation)	t _{PHLT} - t _{PLHT}	MAX222/MAX232A/MAX233/ MAX242/MAX243		300		ns
		MAX220		2000		
Receiver + to - Propagation Delay Difference (Normal Operation)	t _{PHLR} - t _{PLHR}	MAX222/MAX232A/MAX233/ MAX242/MAX243		100		ns
		MAX220		225		

Note 3: All units are production tested at hot. Specifications over temperature are guaranteed by design.

Note 4: MAX243 R2OUT is guaranteed to be low when R2IN ≥ 0V or is unconnected.

典型工作特性

MAX220/MAX222/MAX232A/MAX233A/MAX242/MAX243

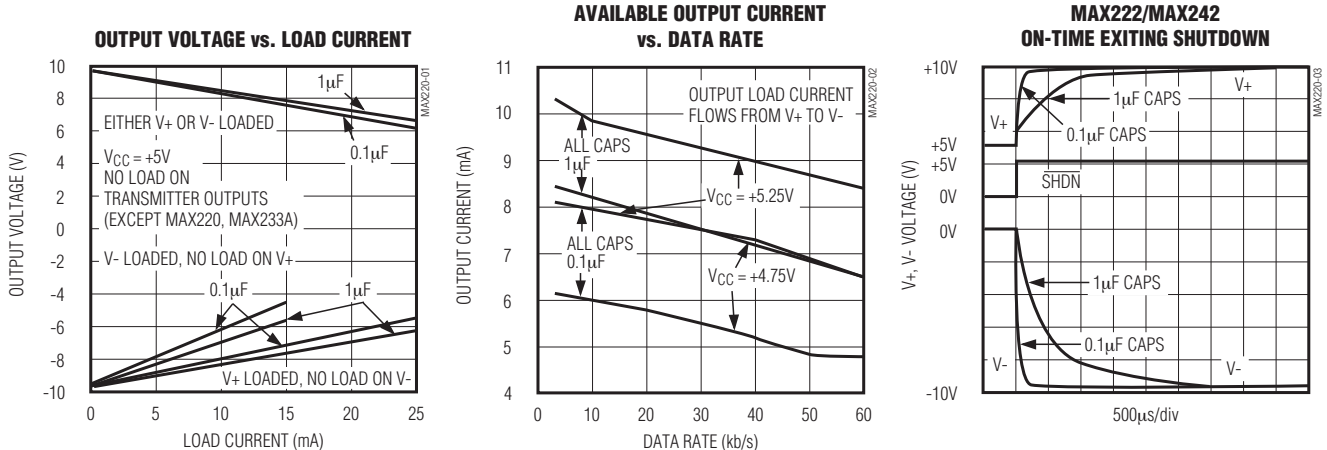

+5V供电、多通道RS-232 驱动器/接收器

MAX220-MAX249

ABSOLUTE MAXIMUM RATINGS—MAX223/MAX230-MAX241

(Voltages referenced to GND.)

V _{CC}	-0.3V to +6V	28-Pin Wide SO (derate 12.50mW/°C above +70°C)	1W
V ₊	(V _{CC} - 0.3V) to +14V	44-Pin Plastic FP (derate 11.11mW/°C above +70°C)	889mW
V ₋	+0.3V to -14V	14-Pin CERDIP (derate 9.09mW/°C above +70°C)	727mW
Input Voltages		16-Pin CERDIP (derate 10.00mW/°C above +70°C)	800mW
T _{IN}	-0.3V to (V _{CC} + 0.3V)	20-Pin CERDIP (derate 11.11mW/°C above +70°C)	889mW
R _{IN}	±30V	24-Pin Narrow CERDIP	
Output Voltages		(derate 12.50mW/°C above +70°C)	1W
T _{OUT}	(V ₊ + 0.3V) to (V ₋ - 0.3V)	24-Pin Sidebrazed (derate 20.0mW/°C above +70°C)	1.6W
R _{OUT}	-0.3V to (V _{CC} + 0.3V)	28-Pin SSOP (derate 9.52mW/°C above +70°C)	762mW
Short-Circuit Duration, T _{OUT} to GND	Continuous	Operating Temperature Ranges	
Continuous Power Dissipation (T _A = +70°C)		MAX2 __ C __	0°C to +70°C
14-Pin Plastic DIP (derate 10.00mW/°C above +70°C)	800mW	MAX2 __ E __	-40°C to +85°C
16-Pin Plastic DIP (derate 10.53mW/°C above +70°C)	842mW	MAX2 __ M __	-55°C to +125°C
20-Pin Plastic DIP (derate 11.11mW/°C above +70°C)	889mW	Storage Temperature Range	-65°C to +160°C
24-Pin Narrow Plastic DIP		Lead Temperature (soldering, 10s)	+300°C
(derate 13.33mW/°C above +70°C)	1.07W	Soldering Temperature (reflow)	
24-Pin Plastic DIP (derate 9.09mW/°C above +70°C)	500mW	20 PDIP (P20M+1)	+225°C
16-Pin Wide SO (derate 9.52mW/°C above +70°C)	762mW	24 PDIP (P24M-1)	+225°C
20-Pin Wide SO (derate 10.00mW/°C above +70°C)	800mW	All other lead(Pb)-free packages	+260°C
24-Pin Wide SO (derate 11.76mW/°C above +70°C)	941mW	All other packages containing lead(Pb)	+240°C

Stresses beyond those listed under "Absolute Maximum Ratings" may cause permanent damage to the device. These are stress ratings only, and functional operation of the device at these or any other conditions beyond those indicated in the operational sections of the specifications is not implied. Exposure to absolute maximum rating conditions for extended periods may affect device reliability.

ELECTRICAL CHARACTERISTICS—MAX223/MAX230-MAX241

(MAX223/230/232/234/236/237/238/240/241, V_{CC} = +5V ±10%; MAX233/MAX235, V_{CC} = +5V ±5%, C1-C4 = 1.0μF; MAX231/MAX239, V_{CC} = +5V ±10%; V₊ = +7.5V to +13.2V; T_A = T_{MIN} to T_{MAX}; unless otherwise noted.) (Note 5)

PARAMETER	CONDITIONS		MIN	TYP	MAX	UNITS
Output Voltage Swing	All transmitter outputs loaded with 3kΩ to ground		±5.0	±7.3		V
V _{CC} Supply Current	No load, T _A = +25°C	MAX232/233		5	10	mA
		MAX223/230/234-238/240/241		7	15	
		MAX231/239		0.4	1	
V ₊ Supply Current		MAX231		1.8	5	mA
		MAX239		5	15	
Shutdown Supply Current	T _A = +25°C	MAX223		15	50	μA
		MAX230/235/236/240/241		1	10	
Input Logic-Low Voltage	T _{IN} , EN, $\overline{\text{SHDN}}$ (MAX233); $\overline{\text{EN}}$, SHDN (MAX230/235-241)				0.8	V
Input Logic-High Voltage	T _{IN}		2.0			V
	EN, $\overline{\text{SHDN}}$ (MAX233); $\overline{\text{EN}}$, SHDN (MAX230/235/236/240/241)		2.4			
Logic Pullup Current	V _{TIN} = 0V			1.5	200	μA
Receiver Input Voltage Operating Range			-30		+30	V

+5V供电、多通道RS-232 驱动器/接收器

ELECTRICAL CHARACTERISTICS—MAX223/MAX230-MAX241 (continued)

(MAX223/230/232/234/236/237/238/240/241, $V_{CC} = +5V \pm 10\%$; MAX233/MAX235, $V_{CC} = +5V \pm 5\%$, $C_1-C_4 = 1.0\mu F$; MAX231/MAX239, $V_{CC} = +5V \pm 10\%$; $V_+ = +7.5V$ to $+13.2V$; $T_A = T_{MIN}$ to T_{MAX} ; unless otherwise noted.) (Note 5)

PARAMETER	CONDITIONS		MIN	TYP	MAX	UNITS	
RS-232 Input Logic-Low Voltage	$T_A = +25^\circ C$, $V_{CC} = +5V$	Normal operation $V_{SHDN} = +5V$ (MAX223) $V_{SHDN} = 0V$ (MAX235/236/240/241)	0.8	1.2		V	
		Shutdown (MAX223) $V_{SHDN} = 0V$, $V_{EN} = +5V$ (R4IN, R5IN)	0.6	1.5			
RS-232 Input Logic-High Voltage	$T_A = +25^\circ C$, $V_{CC} = +5V$	Normal operation $V_{SHDN} = 5V$ (MAX223) $V_{SHDN} = 0V$ (MAX235/236/240/241)		1.7	2.4	V	
		Shutdown (MAX223) $V_{SHDN} = 0V$, $V_{EN} = +5V$ (R4IN, R5IN)		1.5	2.4		
RS-232 Input Hysteresis	$V_{CC} = +5V$, no hysteresis in shutdown		0.2	0.5	1.0	V	
RS-232 Input Resistance	$T_A = +25^\circ C$, $V_{CC} = +5V$		3	5	7	k Ω	
TTL/CMOS Output Voltage Low	$I_{OUT} = 1.6mA$ (MAX231/232/233, $I_{OUT} = 3.2mA$)				0.4	V	
TTL/CMOS Output Voltage High	$I_{OUT} = -1mA$		3.5	$V_{CC} - 0.4$		V	
TTL/CMOS Output Leakage Current	$0V \leq R_{OUT} \leq V_{CC}$; $V_{EN} = 0V$ (MAX223); $V_{EN} = V_{CC}$ (MAX235-241)			± 0.05	± 10	μA	
Receiver Output Enable Time	Normal operation	MAX223		600		ns	
		MAX235/236/239/240/241		400			
Receiver Output Disable Time	Normal operation	MAX223		900		ns	
		MAX235/236/239/240/241		250			
Propagation Delay	RS-232 IN to TTL/CMOS OUT, $C_L = 150pF$	Normal operation		0.5	10	μs	
		$V_{SHDN} = 0V$ (MAX223)	t_{PHLS}		4		40
			t_{PLHS}		6		40
Transition Region Slew Rate	MAX223/MAX230/MAX234-241, $T_A = +25^\circ C$, $V_{CC} = +5V$, $R_L = 3k\Omega$ to $7k\Omega$, $C_L = 50pF$ to $2500pF$, measured from $+3V$ to $-3V$ or $-3V$ to $+3V$		3	5.1	30	V/ μs	
	MAX231/MAX232/MAX233, $T_A = +25^\circ C$, $V_{CC} = +5V$, $R_L = 3k\Omega$ to $7k\Omega$, $C_L = 50pF$ to $2500pF$, measured from $+3V$ to $-3V$ or $-3V$ to $+3V$			4	30		
Transmitter Output Resistance	$V_{CC} = V_+ = V_- = 0V$, $V_{OUT} = \pm 2V$		300			Ω	
Transmitter Output Short-Circuit Current			± 10			mA	

Note 5: All units are production tested at hot except for the MAX240, which is production tested at $T_A = +25^\circ C$. Specifications over temperature are guaranteed by design.

+5V供电、多通道RS-232 驱动器/接收器

典型工作特性

MAX220-MAX249

MAX223/MAX230-MAX241

TRANSMITTER OUTPUT VOLTAGE (V_{OH}) vs. V_{CC}

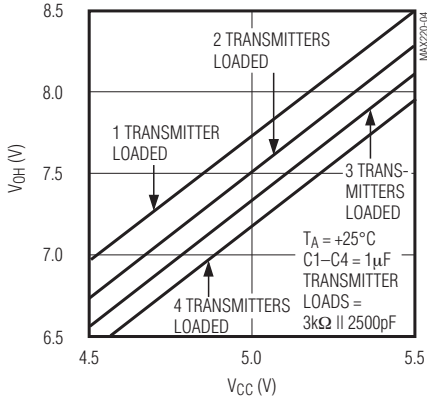

TRANSMITTER OUTPUT VOLTAGE (V_{OH}) vs. LOAD CAPACITANCE AT DIFFERENT DATA RATES

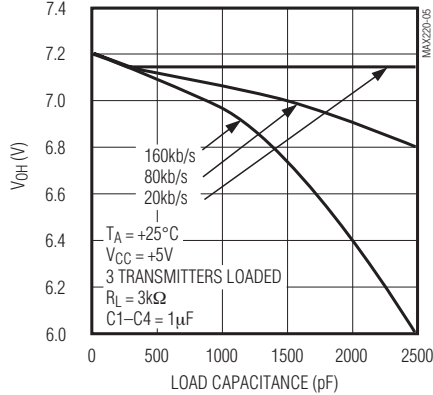

TRANSMITTER SLEW RATE vs. LOAD CAPACITANCE

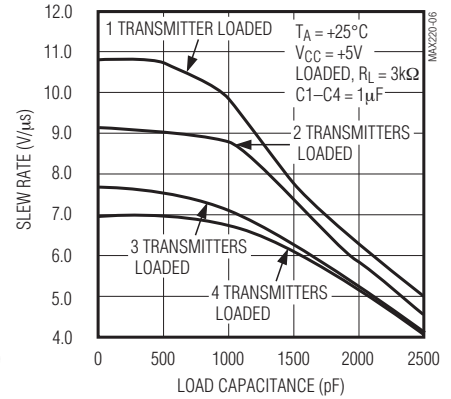

TRANSMITTER OUTPUT VOLTAGE (V_{OL}) vs. V_{CC}

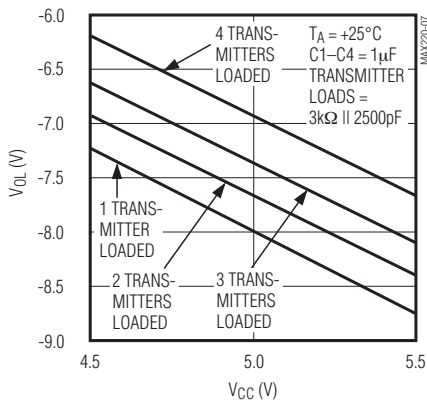

TRANSMITTER OUTPUT VOLTAGE (V_{OL}) vs. LOAD CAPACITANCE AT DIFFERENT DATA RATES

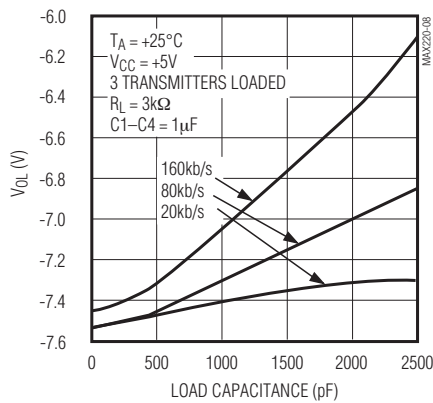

TRANSMITTER OUTPUT VOLTAGE (V_+ , V_-) vs. LOAD CURRENT

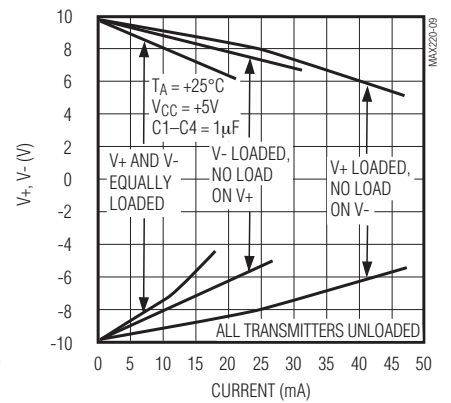

V_+ , V_- WHEN EXITING SHUTDOWN ($1\mu\text{F}$ CAPACITORS)

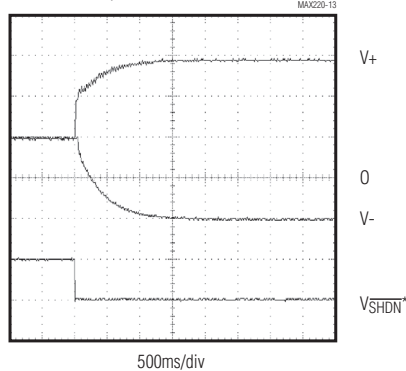

*SHUTDOWN POLARITY IS REVERSED FOR NON MAX241 PARTS

+5V供电、多通道RS-232 驱动器/接收器

ABSOLUTE MAXIMUM RATINGS—MAX225/MAX244-MAX249

(Voltages referenced to GND.)		Continuous Power Dissipation (T _A = +70°C)
Supply Voltage (V _{CC})	-0.3V to +6V	28-Pin Wide SO (derate 12.50mW/°C above +70°C)1W
Input Voltages		40-Pin Plastic DIP (derate 11.11mW/°C above +70°C) ...611mW
T _{IN} , EN _A , EN _B , EN _R , EN _T , EN _R _A , EN _R _B , EN _T _A , EN _T _B	-0.3V to (V _{CC} + 0.3V)	44-Pin PLCC (derate 13.33mW/°C above +70°C)1.07W
R _{IN}	±25V	Operating Temperature Ranges
T _{OUT} (Note 6)	±15V	MAX225C_-, MAX24_C_-0°C to +70°C
R _{OUT}	-0.3V to (V _{CC} + 0.3V)	MAX225E_-, MAX24_E_--40°C to +85°C
Short Circuit Duration (one output at a time)		Storage Temperature Range-65°C to +160°C
T _{OUT} to GND	Continuous	Lead Temperature (soldering, 10s)+300°C
R _{OUT} to GND	Continuous	Soldering Temperature (reflow)
		40 PDIP (P40M-2)+225°C
		All other lead(Pb)-free packages+260°C
		All other packages containing lead(Pb)+240°C

Note 6: Input voltage measured with transmitter output in a high-impedance state, shutdown, or V_{CC} = 0V.

Stresses beyond those listed under "Absolute Maximum Ratings" may cause permanent damage to the device. These are stress ratings only, and functional operation of the device at these or any other conditions beyond those indicated in the operational sections of the specifications is not implied. Exposure to absolute maximum rating conditions for extended periods may affect device reliability.

ELECTRICAL CHARACTERISTICS—MAX225/MAX244-MAX249

(MAX225, V_{CC} = +5.0V ±5%; MAX244-MAX249, V_{CC} = +5.0V ±10%, external capacitors C1-C4 = 1μF; T_A = T_{MIN} to T_{MAX}; unless otherwise noted.) (Note 7)

PARAMETER	CONDITIONS	MIN	TYP	MAX	UNITS
RS-232 TRANSMITTERS					
Input Logic-Low Voltage			1.4	0.8	V
Input Logic-High Voltage		2	1.4		V
Logic Pullup/Input Current	Tables 1a-1d	Normal operation	10	50	μA
		Shutdown	±0.01	±1	
Data Rate	Tables 1a-1d, normal operation		120	64	kbps
Output Voltage Swing	All transmitter outputs loaded with 3kΩ to GND	±5	±7.5		V
Output Leakage Current (Shutdown)	Tables 1a-1d	V _{EN_A} , V _{EN_B} , V _{EN_T} , V _{EN_T_A} , V _{EN_T_B} = V _{CC} , V _{OUT} = ±15V	±0.01	±25	μA
		V _{CC} = 0V, V _{OUT} = ±15V	±0.01	±25	
Transmitter Output Resistance	V _{CC} = V ₊ = V ₋ = 0V, V _{OUT} = ±2V (Note 8)	300	10M		Ω
Output Short-Circuit Current	V _{OUT} = 0V	±7	±30		mA
RS-232 RECEIVERS					
RS-232 Input Voltage Operating Range				±25	V
RS-232 Input Logic-Low Voltage	V _{CC} = +5V	0.8	1.3		V
RS-232 Input Logic-High Voltage	V _{CC} = +5V		1.8	2.4	V
RS-232 Input Hysteresis	V _{CC} = +5V	0.2	0.5	1.0	V
RS-232 Input Resistance		3	5	7	kΩ
TTL/CMOS Output Voltage Low	I _{OUT} = 3.2mA		0.2	0.4	V
TTL/CMOS Output Voltage High	I _{OUT} = -1.0mA	3.5	V _{CC} - 0.2		V
TTL/CMOS Output Short-Circuit Current	Sourcing V _{OUT} = V _{GND}	-2	-10		mA
	Sinking V _{OUT} = V _{CC}	10	30		
TTL/CMOS Output Leakage Current	Normal operation, outputs disabled, Tables 1a-1d, 0V ≤ V _{OUT} ≤ V _{CC} , V _{EN_R} = V _{CC}		±0.05	±0.10	μA

+5V供电、多通道RS-232 驱动器/接收器

MAX220-MAX249

ELECTRICAL CHARACTERISTICS—MAX225/MAX244-MAX249 (continued)

(MAX225, $V_{CC} = +5.0V \pm 5\%$; MAX244-MAX249, $V_{CC} = +5.0V \pm 10\%$, external capacitors C1-C4 = 1 μ F; $T_A = T_{MIN}$ to T_{MAX} ; unless otherwise noted.) (Note 7)

PARAMETER	CONDITIONS		MIN	TYP	MAX	UNITS
POWER SUPPLY AND CONTROL LOGIC						
Supply Voltage Range		MAX225	4.75		5.25	V
		MAX244-MAX249	4.5		5.5	
V_{CC} Supply Current (Normal Operation)	No load	MAX225		10	20	mA
		MAX244-MAX249		11	30	
	3k Ω loads on all outputs	MAX225		40		
		MAX244-MAX249		57		
Shutdown Supply Current	$T_A = +25^\circ\text{C}$			8	25	μ A
	$T_A = T_{MIN}$ to T_{MAX}				50	
Control Input	Leakage current				± 1	μ A
	Logic-low voltage			1.4	0.8	V
	Logic-high voltage		2.4	1.4		
AC CHARACTERISTICS						
Transition Slew Rate	$C_L = 50\text{pF}$ to 2500pF , $R_L = 3\text{k}\Omega$ to $7\text{k}\Omega$, $V_{CC} = +5\text{V}$, $T_A = +25^\circ\text{C}$, measured from +3V to -3V or -3V to +3V		5	10	30	V/ μ s
Transmitter Propagation Delay TLL to RS-232 (Normal Operation)	t_{PHLT} , Figure 1			1.3	3.5	μ s
	t_{PLHT} , Figure 1			1.5	3.5	
Receiver Propagation Delay TLL to RS-232 (Normal Operation)	t_{PHLR} , Figure 2			0.6	1.5	μ s
	t_{PLHR} , Figure 2			0.6	1.5	
Receiver Propagation Delay TLL to RS-232 (Low-Power Mode)	t_{PHLS} , Figure 2			0.6	10	μ s
	t_{PLHS} , Figure 2			3.0	10	
Transmitter + to - Propagation Delay Difference (Normal Operation)	$t_{PHLT} - t_{PLHT}$			350		ns
Receiver + to - Propagation Delay Difference (Normal Operation)	$t_{PHLR} - t_{PLHR}$			350		ns
Receiver-Output Enable Time	t_{ER} , Figure 3			100	500	ns
Receiver-Output Disable Time	t_{DR} , Figure 3			100	500	ns
Transmitter Enable Time	t_{ET}	MAX246-MAX249 (excludes charge-pump startup)		5		μ s
		MAX225/MAX245-MAX249 (includes charge-pump startup)		10		ms
Transmitter Disable Time	t_{DT} , Figure 4			100		ns

Note 7: All units production tested at hot. Specifications over temperature are guaranteed by design.

Note 8: The 300 Ω minimum specification complies with EIA/TIA-232E, but the actual resistance when in shutdown mode or $V_{CC} = 0\text{V}$ is 10M Ω as is implied by the leakage specification.

+5V供电、多通道RS-232 驱动器/接收器

典型工作特性

MAX225/MAX244-MAX249

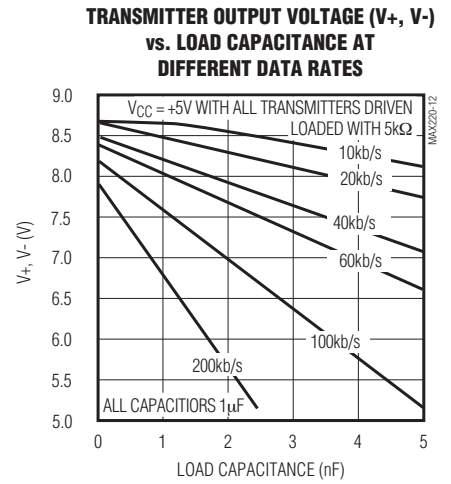
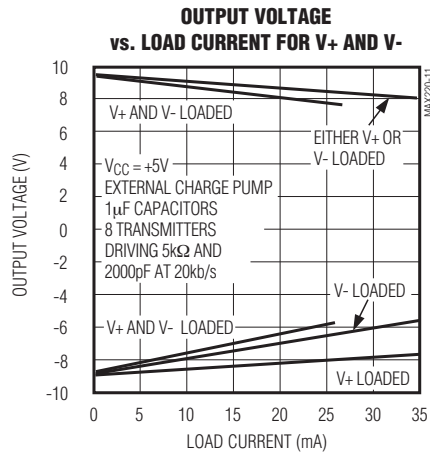
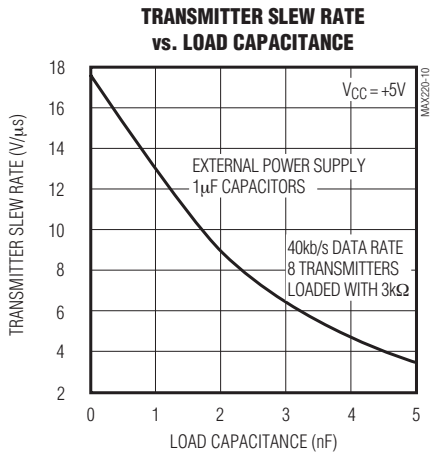

+5V供电、多通道RS-232 驱动器/接收器

测试电路/时序图

MAX220-MAX249



图1. 发送器传输延时



图2. 接收器传输延时

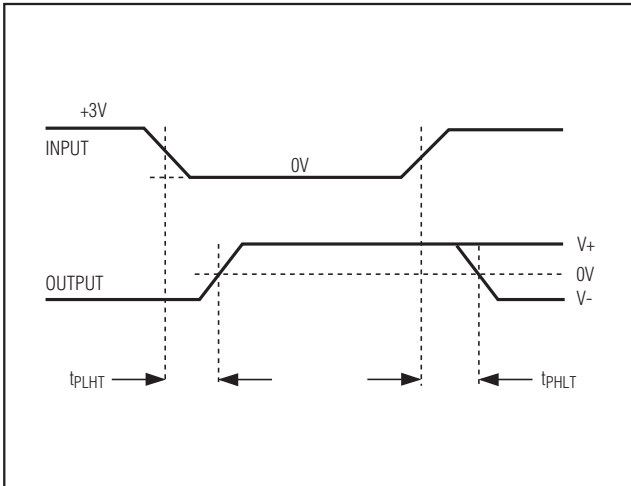

图3. 接收器输出使能与禁用时序

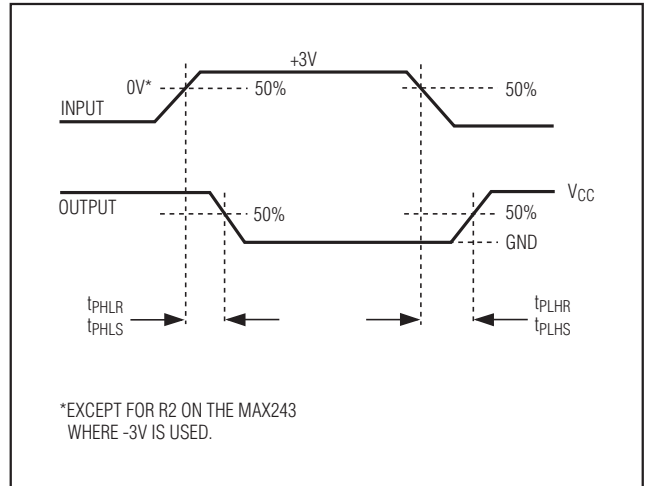

图4. 发送器输出禁用时序

+5V供电、多通道RS-232 驱动器/接收器

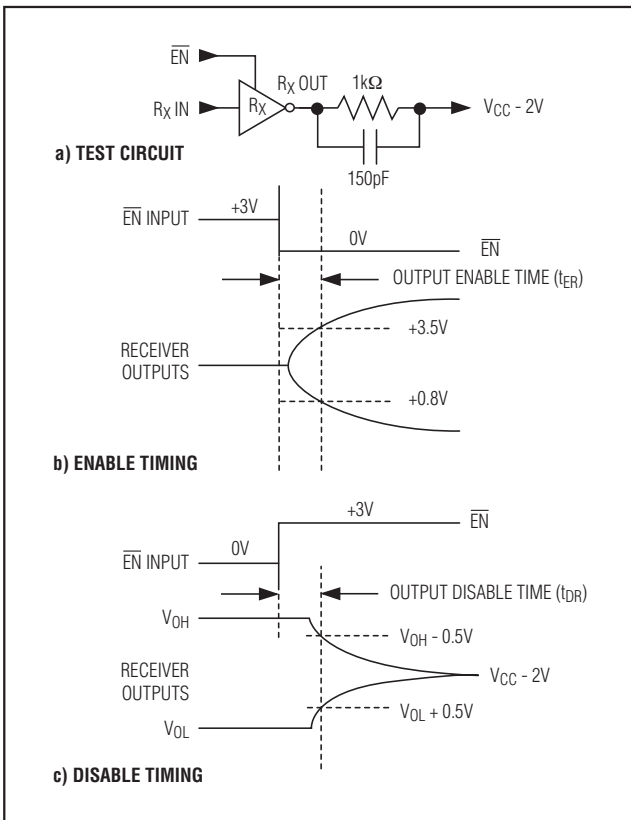
控制引脚配置表

表 1a. MAX245控制引脚配置

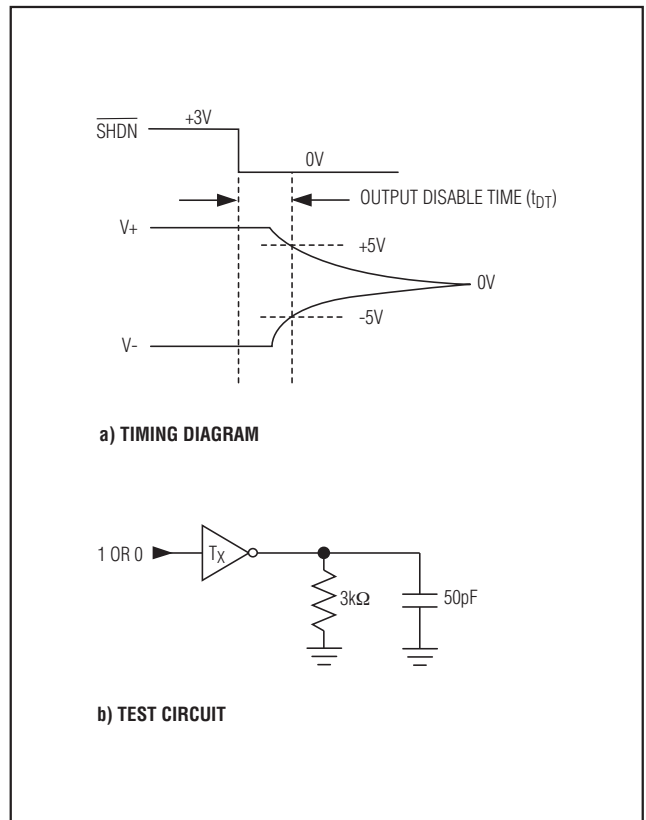
$\overline{\text{ENT}}$	$\overline{\text{ENR}}$	OPERATION STATUS	TRANSMITTERS	RECEIVERS
0	0	Normal Operation	All Active	All Active
0	1	Normal Operation	All Active	All High-Z
1	0	Shutdown	All High-Z	All Low-Power Receive Mode
1	1	Shutdown	All High-Z	All High-Z

表 1b. MAX245控制引脚配置

$\overline{\text{ENT}}$	$\overline{\text{ENR}}$	OPERATION STATUS	TRANSMITTERS		RECEIVERS	
			TA1-TA4	TB1-TB4	RA1-RA5	RB1-RB5
0	0	Normal Operation	All Active	All Active	All Active	All Active
0	1	Normal Operation	All Active	All Active	RA1-RA4 High-Z, RA5 Active	RB1-RB4 High-Z, RB5 Active
1	0	Shutdown	All High-Z	All High-Z	All Low-Power Receive Mode	All Low-Power Receive Mode
1	1	Shutdown	All High-Z	All High-Z	RA1-RA4 High-Z, RA5 Low-Power Receive Mode	RB1-RB4 High-Z, RB5 Low-Power Receive Mode

表 1c. MAX246控制引脚配置

$\overline{\text{ENA}}$	$\overline{\text{ENB}}$	OPERATION STATUS	TRANSMITTERS		RECEIVERS	
			TA1-TA4	TB1-TB4	RA1-RA5	RB1-RB5
0	0	Normal Operation	All Active	All Active	All Active	All Active
0	1	Normal Operation	All Active	All High-Z	All Active	RB1-RB4 High-Z, RB5 Active
1	0	Shutdown	All High-Z	All Active	RA1-RA4 High-Z, RA5 Active	All Active
1	1	Shutdown	All High-Z	All High-Z	RA1-RA4 High-Z, RA5 Low-Power Receive Mode	RB1-RB4 High-Z, RA5 Low-Power Receive Mode

+5V供电、多通道RS-232 驱动器/接收器

MAX220-MAX249

表 1d. MAX247/MAX248/MAX249控制引脚配置

$\overline{\text{ENTA}}$	$\overline{\text{ENTB}}$	$\overline{\text{ENRA}}$	$\overline{\text{ENRB}}$	OPERATION STATUS	TRANSMITTERS			RECEIVERS	
					MAX247	TA1-TA4	TB1-TB4	RA1-RA4	RB1-RB5
					MAX248	TA1-TA4	TB1-TB4	RA1-RA4	RB1-RB4
					MAX249	TA1-TA3	TB1-TB3	RA1-RA5	RB1-RB5
0	0	0	0	Normal Operation		All Active	All Active	All Active	All Active
0	0	0	1	Normal Operation		All Active	All Active	All Active	All High-Z, except RB5 stays active on MAX247
0	0	1	0	Normal Operation		All Active	All Active	All High-Z	All Active
0	0	1	1	Normal Operation		All Active	All Active	All High-Z	All High-Z, except RB5 stays active on MAX247
0	1	0	0	Normal Operation		All Active	All High-Z	All Active	All Active
0	1	0	1	Normal Operation		All Active	All High-Z	All Active	All High-Z, except RB5 stays active on MAX247
0	1	1	0	Normal Operation		All Active	All High-Z	All High-Z	All Active
0	1	1	1	Normal Operation		All Active	All High-Z	All High-Z	All High-Z, except RB5 stays active on MAX247
1	0	0	0	Normal Operation		All High-Z	All Active	All Active	All Active
1	0	0	1	Normal Operation		All High-Z	All Active	All Active	All High-Z, except RB5 stays active on MAX247
1	0	1	0	Normal Operation		All High-Z	All Active	All High-Z	All Active
1	0	1	1	Normal Operation		All High-Z	All Active	All High-Z	All High-Z, except RB5 stays active on MAX247
1	1	0	0	Shutdown		All High-Z	All High-Z	Low-Power Receive Mode	Low-Power Receive Mode
1	1	0	1	Shutdown		All High-Z	All High-Z	Low-Power Receive Mode	All High-Z, except RB5 stays active on MAX247
1	1	1	0	Shutdown		All High-Z	All High-Z	All High-Z	Low-Power Receive Mode
1	1	1	1	Shutdown		All High-Z	All High-Z	All High-Z	All High-Z, except RB5 stays active on MAX247

+5V供电、多通道RS-232 驱动器/接收器

详细说明

MAX220-MAX249包含4个部分：双路电荷泵DC-DC电压转换器、RS-232驱动器、RS-232接收器，以及接收器与发送器使能控制输入。

双路电荷泵电压转换器

MAX220-MAX249内部有两个电荷泵，将+5V转换为±10V(空载)，为RS-232驱动器提供工作电压。第一个转换器利用电容C1将+5V输入加倍，得到V₊输出端C3上的+10V；第二个转换器利用电容C2将+10V转换为V₋输出端C4上的-10V。

可以从+10V(V₊)和-10V(V₋)输出端获取少量的电源功率，为外部电路供电(参见典型工作特性部分)；但MAX225与MAX245-MAX247例外，因为它们不提供这些引脚。V₊与V₋未经稳压，所以输出电压会随负载电流的增大而下降。当V₊、V₋为外部电路提供电流时，注意不要因为所加负载的原因使V₊、V₋低于EIA/TIA-232E驱动器输出电压最小值±5V的限制。

使用MAX222、MAX225、MAX230、MAX235、MAX236、MAX240、MAX241以及MAX245-MAX249上的关断功能时，应避免V₊与V₋为外部电路供电。这些器件关断时，V₋降至0V，V₊降至+5V。对于那些能够将+10V外部电源提供到V₊引脚(而不是使用内部电荷泵来产生+10V)的应用，一定不要安装电容C1，并且必须将SHDN引脚连接至V_{CC}，这是因为在关断模式下V₊被内部连接到V_{CC}。

RS-232驱动器

如果负载是标称值为5kΩ的RS-232接收器，并且V_{CC} = +5V时，驱动器输出电压摆幅的典型值为±8V。输出摆幅确保符合EIA/TIA-232E和V.28规范，该规范要求在最糟糕的情况下能够满足±5V驱动器输出电压最小值的要求，其中包括3kΩ的负载电阻最小值、V_{CC} = +4.5V以及最高工作温度。空载时驱动器输出电压范围是(V₊ - 1.3V)至(V₋ + 0.5V)。

输入门限兼容于TTL和CMOS逻辑。未使用的驱动器输入端可以不连接，有内置的、与V_{CC}相连的400kΩ输入上拉电阻(MAX220除外)。上拉电阻将未使用的驱动器输出端强制为低电平，因为所有驱动器都是反相的。除了在上拉被禁用的关断模式下，内部输入上拉电阻通常消耗12μA电流。在关断模式、三态模式或器件电源被断开的

情况下，驱动器输出关闭，并进入高阻状态，该状态下的漏电流通常只有几个微安(最大值为25μA)。输出可以被驱动到±15V。在关断模式下，电源电流通常降至8μA。MAX220不具备内部上拉电阻，所以不能将未使用的驱动器输出强制为低电平，请将未使用的输入端连接至GND或V_{CC}。

MAX239具有接收器三态控制线，而MAX223、MAX225、MAX235、MAX236、MAX240与MAX241同时具备接收器三态控制与低功耗关断控制。表2说明了关断控制与接收器三态控制对接收器输出的影响。

只要三态使能线为高电平(对于MAX225/MAX235/MAX236/MAX239-MAX241)，接收器TTL/CMOS输出就处于高阻、三态模式；另外，当关断控制线为高电平，也将处于高阻状态。

在低功耗关断模式下，驱动器输出被关闭，其漏电流小于1μA，同时驱动器输出被拉至地。驱动器输出漏电流始终小于1μA，即便发送器输出被反相驱动在0V至(V_{CC} + 6V)。低于-0.5V时，发送器由二极管箝位至地，具有1kΩ串联阻抗。发送器还可以被齐纳管箝位到大约V_{CC} + 6V，具有1kΩ串联阻抗。

驱动器输出摆率限制在30V/μs以内，与EIA/TIA-232E和V.28规范的要求一致。摆率典型值为：空载下24V/μs，3Ω与2500pF负载下10V/μs。

RS-232接收器

EIA/TIA-232E与V.28规范将大于3V的电压定义为逻辑0，因此，所有接收器都是反相的。输入门限设定为0.8V和2.4V，接收器既响应TTL电平输入，也响应EIA/TIA-232E与V.28电平。

接收器输入可以承受最高±25V的过压输入，并提供标称值为5kΩ的输入端接电阻。接收器符合V.28和EIA/TIA-232E关于第一类故障条件的说明。

表2. 接收器的三态控制

PART	SHDN	SHDN	EN	EN(R)	RECEIVERS
MAX223	—	Low High High	X Low High	—	High Impedance Active High Impedance
MAX225	—	—	—	Low High	High Impedance Active
MAX235 MAX236 MAX240	Low Low High	—	—	Low High X	High Impedance Active High Impedance

+5V供电、多通道RS-232 驱动器/接收器

接收器输入滞回的典型值为0.5V，并可确保0.2V最小值。这样，对于慢变化输入信号可以产生明确的输出跳变，即使是在有一定噪声和振荡的情况下。接收器传输延时典型值为600ns，与输入摆幅方向无关。

低功耗接收模式

MAX223、MAX242以及MAX245-MAX249具有低功耗接收模式，可以使IC进入关断状态，但仍允许器件接收信息。这对周期性唤醒工作的应用非常重要。在低功耗接收模式下，系统仍然可以接收唤醒器件的指令信号，使其准备就绪、进行高数据速率的通信。这种操作可以节省系统功耗。

负门限—MAX243

MAX243和MAX232A引脚兼容，唯一的区别是去掉了两个接收器输入之一的RS-232电缆故障保护。这意味着CTS与RTS等控制线可以被驱动或不连接，而不会中断通信。不必用不同的电缆连接不同的设备。

没有电缆故障保护的接收器输入门限是-0.8V，而不是+1.4V。只有当输入与有源驱动为负的控制线相连时，输出才变为正。若没有驱动，则缺省状态为0，或“允许发送”状态。通常，MAX243的另一个接收器(+1.4V门限)用于数据线(TD或RD)，而负门限接收器与控制线(DTR、DTS、CTS、RTS等)连接。

RS-232系列的其他产品按照EIA/TIA-232E规范的规定，采用可选的电缆故障保护。这意味着只要输入被驱动为负、不连接或短路至地时，接收器输出就变为高电平。高电平的输出通知串行通信IC停止发送数据。为避免这种情况，控制线必须被驱动或与跳线连接，使其具有一定的正电压。

关断—MAX222-MAX242

关断状态下，MAX222、MAX235、MAX236、MAX240与MAX241的所有接收器都被禁用。当芯片处于关断状态时，MAX223与MAX242的两个接收器在低功耗模式下保持工作状态。在这样的条件下，对于由高到低的输入跳变，传输延时增加到大约2.5 μ s。关断状态下，接收器作为没有滞回的CMOS反相器工作。MAX223与MAX242还具有接收器使能输入端(在MAX242中是 \overline{EN} 、MAX223中是EN)，使接收器的输出控制与 \overline{SHDN} (在MAX241中是SHDN)无关。所有其他器件的 \overline{SHDN} (在MAX241中是SHDN)也可以禁止接收器输出。

MAX225提供5个发送器和5个接收器；MAX245提供10个接收器和8个发送器。这两种器件都具有独立的接收器与发送器使能控制。当ENT输入端作用有逻辑高电平时，电荷泵关闭并且器件关断。在这种状态下，电源电流降至25 μ A以内，而且接收器在低功耗接收模式下保持工作，驱动器输出进入高阻态(三态模式)。MAX225的所有5个接收器都由 \overline{ENR} 输入控制。MAX245的8个接收器输出由 \overline{ENR} 输入控制，而另外两个接收器(RA5与RB5)始终保持有效。当 \overline{ENR} 为逻辑高电平时，RA1-RA4以及RB1-RB4进入三态模式。

接收器与发送器使能控制输入

MAX225以及MAX245-MAX249具有发送器和接收器使能控制。

接收器有三种工作模式：全速接收(正常有效)、三态(禁用)以及低功耗接收(以较低的数据速率使接收器继续保持有效)。接收器使能输入端控制全速接收和三态模式。发送器具有两种工作模式：全速发送(正常有效)和三态(禁用)。发送器使能输入端还被用来控制关断模式。所有发送器被禁用时，器件进入关断模式。器件关断时，有效的接收器工作在低功耗接收模式下。

+5V供电、多通道RS-232 驱动器/接收器

表1a-1d定义了控制状态。MAX244没有控制引脚，因此没有包含在这些表中。

MAX246具有10个接收器和8个驱动器，带两个控制引脚，分别控制器件的两侧。A侧控制输入($\overline{\text{ENA}}$)为逻辑高电平时，使4个A侧的接收器和驱动器进入三态模式；同理，B侧控制输入($\overline{\text{ENB}}$)可以使4个B侧的驱动器与接收器进入三态模式。而在MAX245中，一个A侧的接收器和一个B侧的接收器(RA5与RB5)将始终保持有效。当A侧、B侧都被禁用($\overline{\text{ENA}} = \overline{\text{ENB}} = +5\text{V}$)时，整个器件进入关断模式。

MAX247提供9个接收器和8个驱动器，带4个控制引脚。 $\overline{\text{ENRA}}$ 、 $\overline{\text{ENRB}}$ 是接收器使能输入端，分别控制4个接收器输出。 $\overline{\text{ENTA}}$ 、 $\overline{\text{ENTB}}$ 是发送器使能输入端，分别控制4个驱动器。第9个接收器(RB5)始终有效。该器件在 $\overline{\text{ENTA}}$ 与 $\overline{\text{ENTB}}$ 均为逻辑高电平时进入关断模式。

MAX248提供8个接收器和8个驱动器，带4个控制引脚。 $\overline{\text{ENRA}}$ 、 $\overline{\text{ENRB}}$ 是接收器使能输入端，分别控制4个接收

器输出。 $\overline{\text{ENTA}}$ 、 $\overline{\text{ENTB}}$ 是发送器使能输入端，分别控制4个驱动器。该器件中没有始终有效的接收器。该器件在 $\overline{\text{ENTA}}$ 、 $\overline{\text{ENTB}}$ 均为逻辑高电平时进入关断模式，同时发送器进入三态模式。

MAX249提供10个接收器和6个驱动器，带4个控制引脚。 $\overline{\text{ENRA}}$ 、 $\overline{\text{ENRB}}$ 是接收器使能输入端，分别控制5个接收器输出。 $\overline{\text{ENTA}}$ 、 $\overline{\text{ENTB}}$ 是发送器使能输入端，分别控制3个驱动器。该器件中没有始终有效的接收器。该器件在 $\overline{\text{ENTA}}$ 、 $\overline{\text{ENTB}}$ 均为逻辑高电平时进入关断模式，同时发送器进入三态模式。在关断模式下，保持有效的接收器工作在低功耗接收模式，最高数据速率为20kb/s。

应用信息

图5至图25给出了引脚配置与典型工作电路。在对电源噪声敏感的应用中， V_{CC} 可以用与C1、C2数值相同的电容耦合至地，电容应尽可能靠近器件摆放。

+5V供电、多通道RS-232 驱动器/接收器

MAX220-MAX249

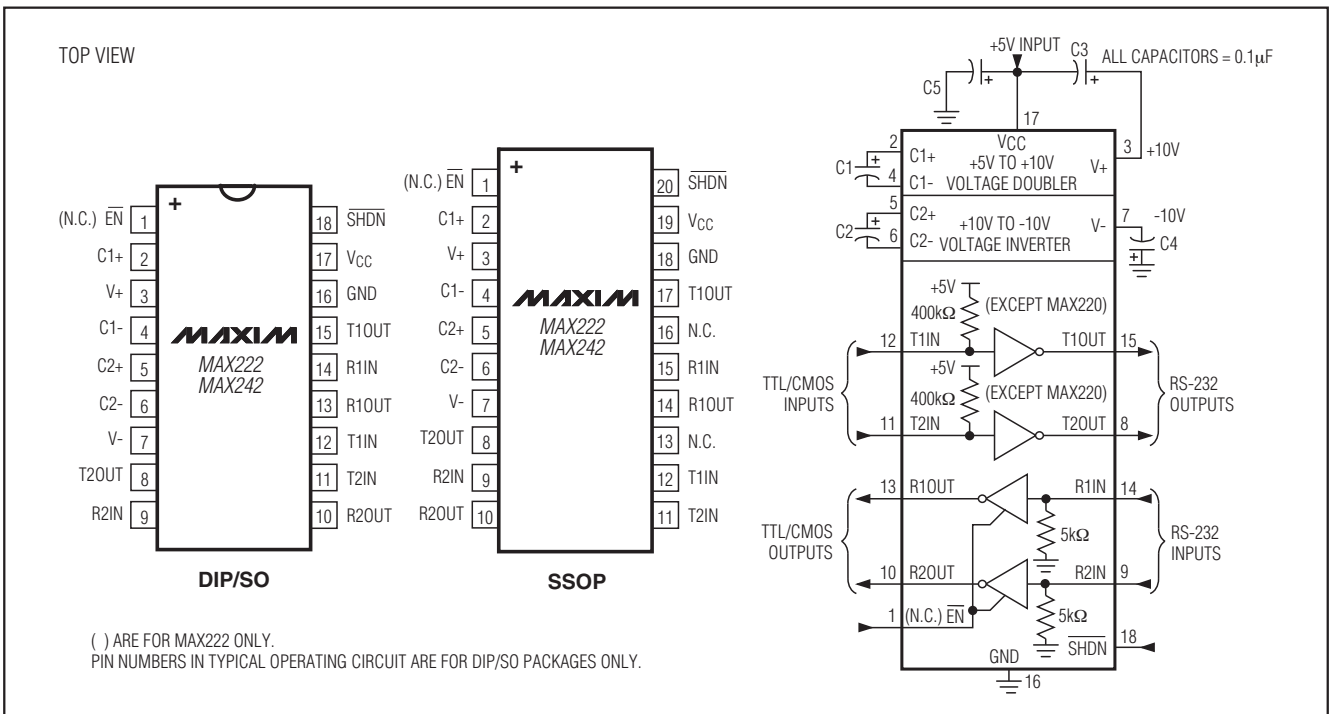
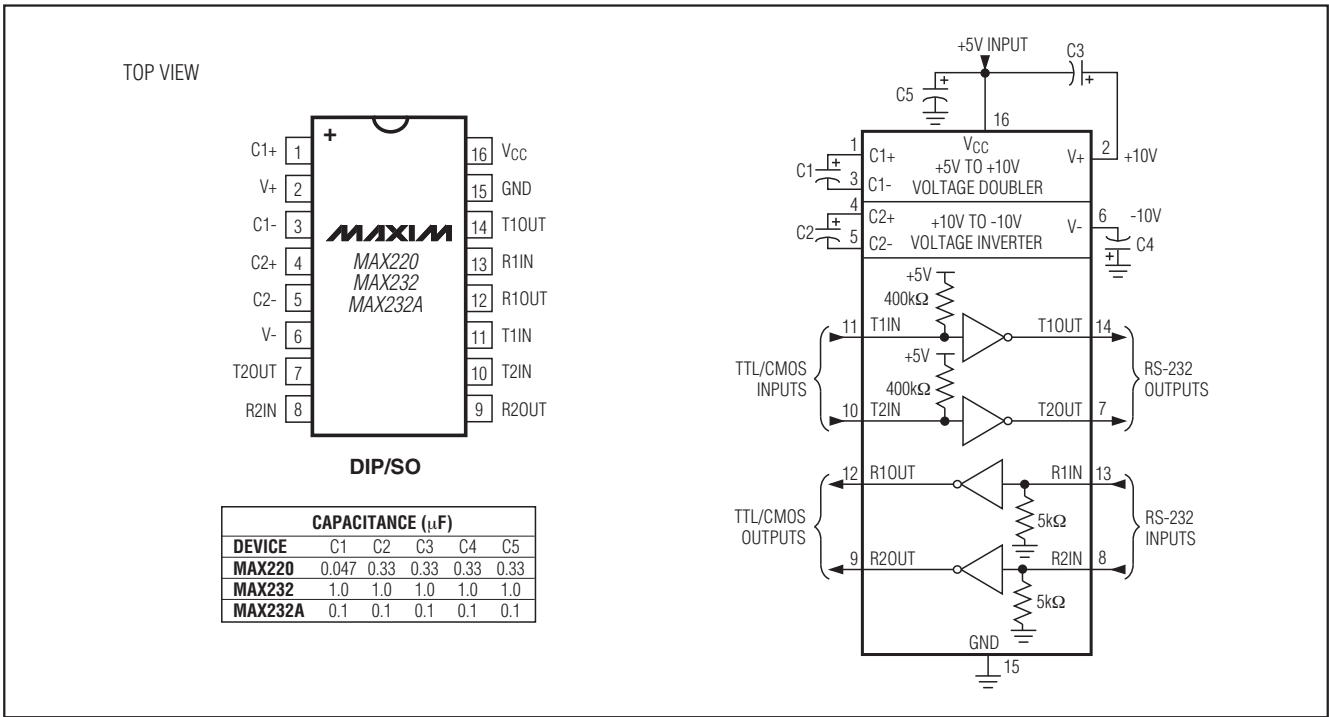

+5V供电、多通道RS-232 驱动器/接收器

TOP VIEW

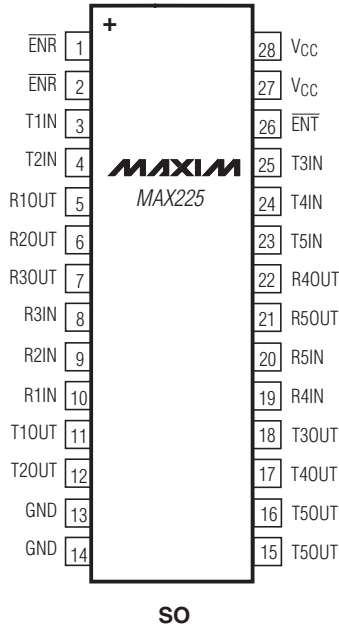

MAX225 FUNCTIONAL DESCRIPTION

5 RECEIVERS

5 TRANSMITTERS

2 CONTROL PINS

1 RECEIVER ENABLE ($\overline{\text{ENR}}$)

1 TRANSMITTER ENABLE ($\overline{\text{ENT}}$)

PINS ($\overline{\text{ENR}}$, GND, V_{CC} , T5OUT) ARE INTERNALLY CONNECTED.
CONNECT EITHER OR BOTH EXTERNALLY. T5OUT IS A SINGLE DRIVER.



图7. MAX225引脚配置与典型工作电路

+5V供电、多通道RS-232 驱动器/接收器

MAX220-MAX249

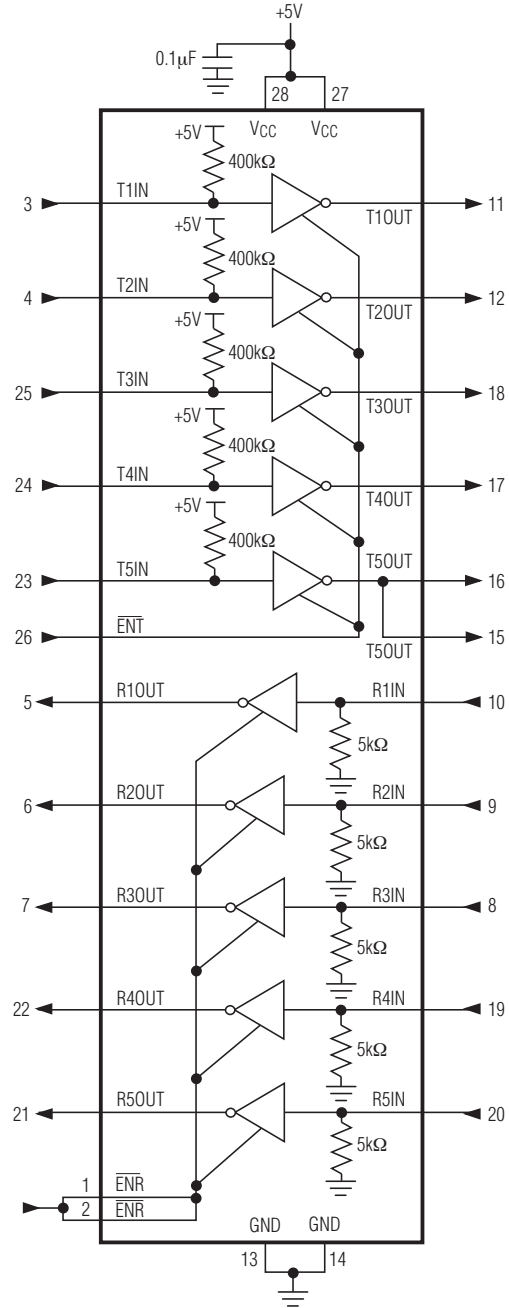

图8. MAX223/MAX241 引脚配置与典型工作电路

+5V供电、多通道RS-232 驱动器/接收器



图9. MAX230引脚配置与典型工作电路

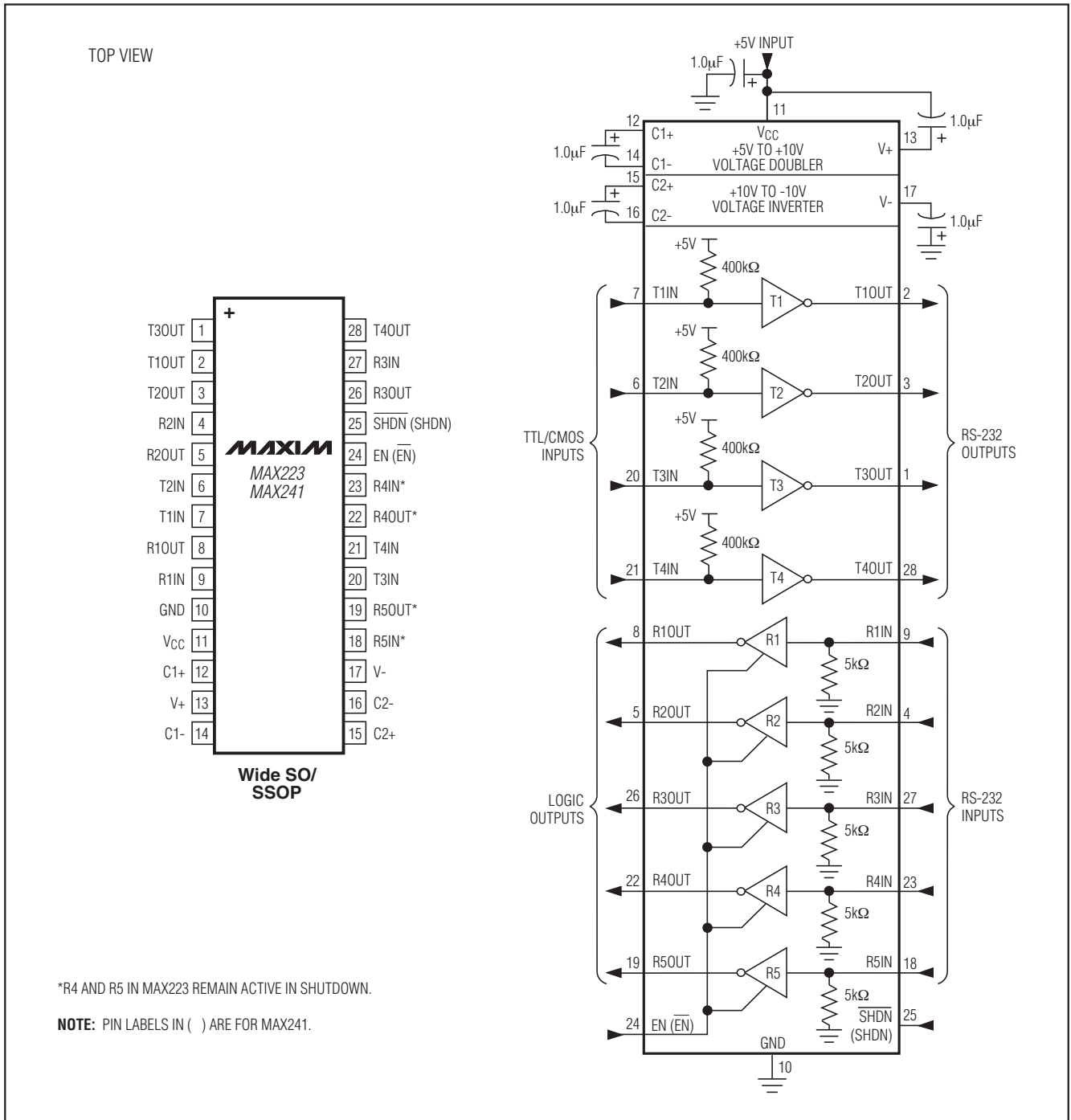

图10. MAX231引脚配置与典型工作电路

+5V供电、多通道RS-232 驱动器/接收器

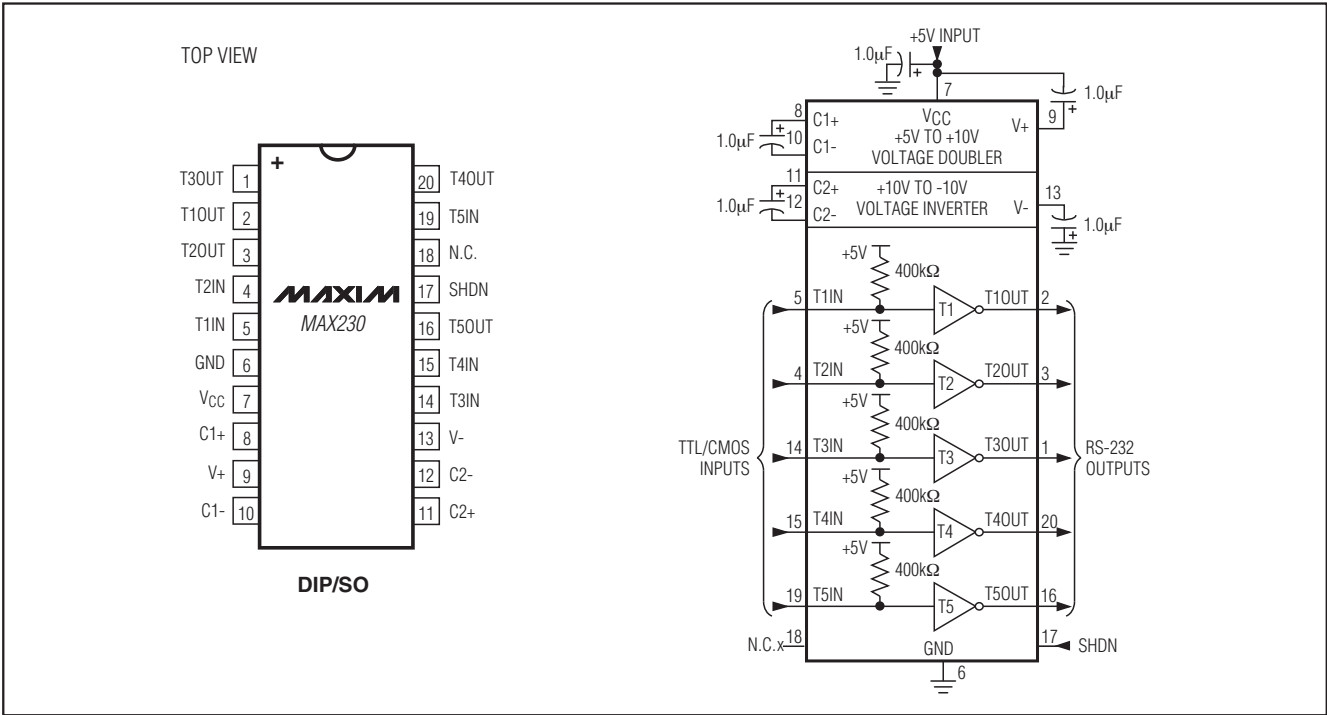
MAX220-MAX249

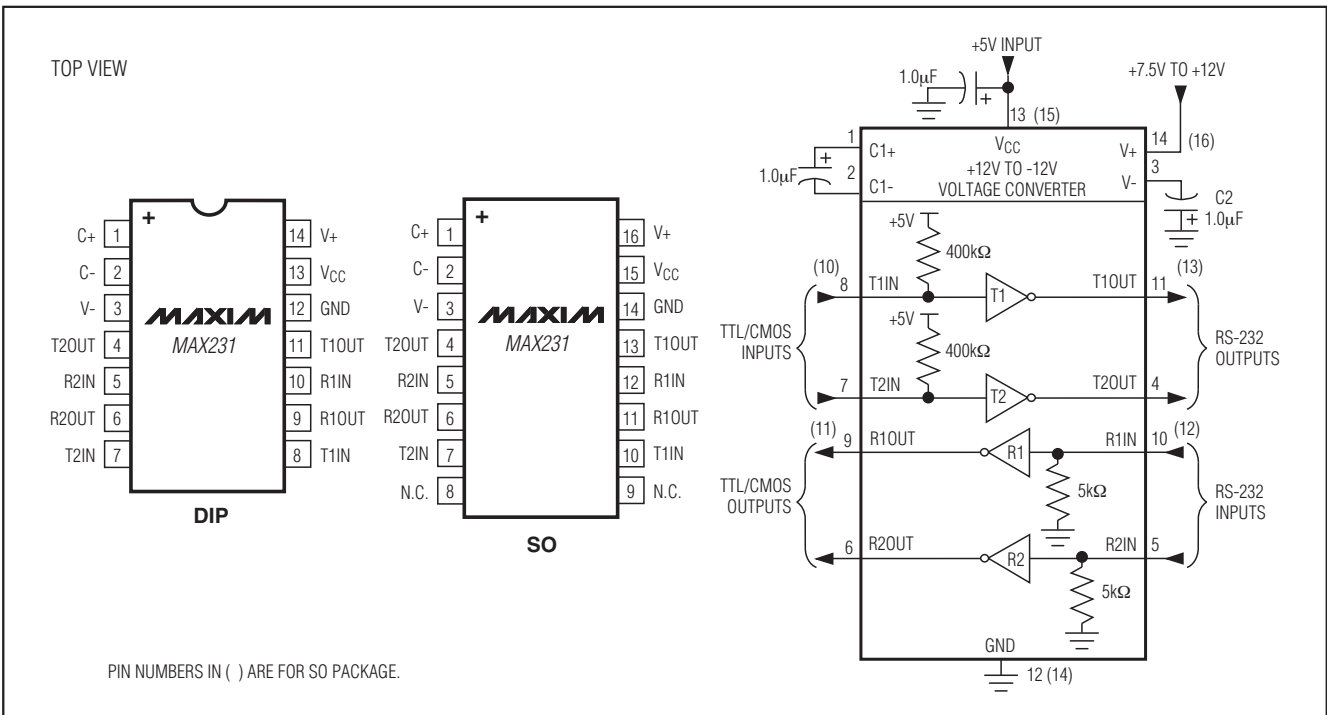

图11. MAX233/MAX233A 引脚配置与典型工作电路



图12. MAX234 引脚配置与典型工作电路

+5V供电、多通道RS-232 驱动器/接收器

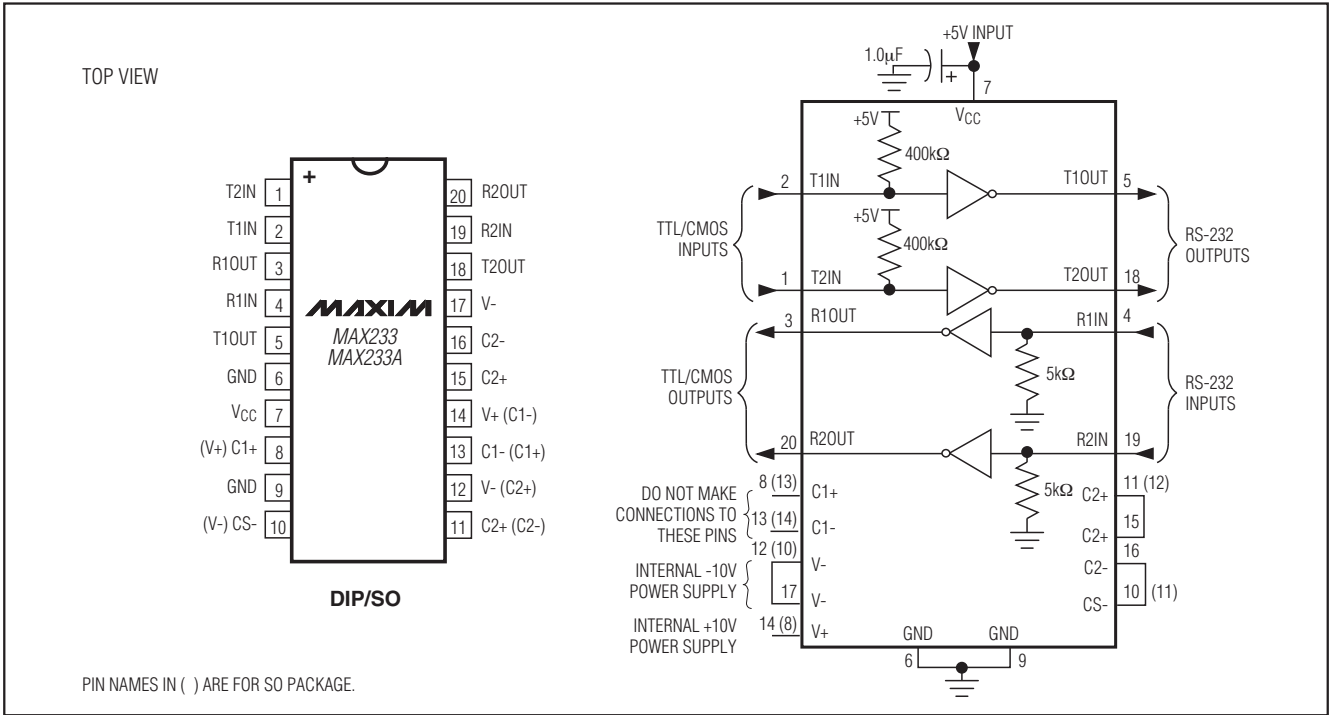

图13. MAX235引脚配置与典型工作电路

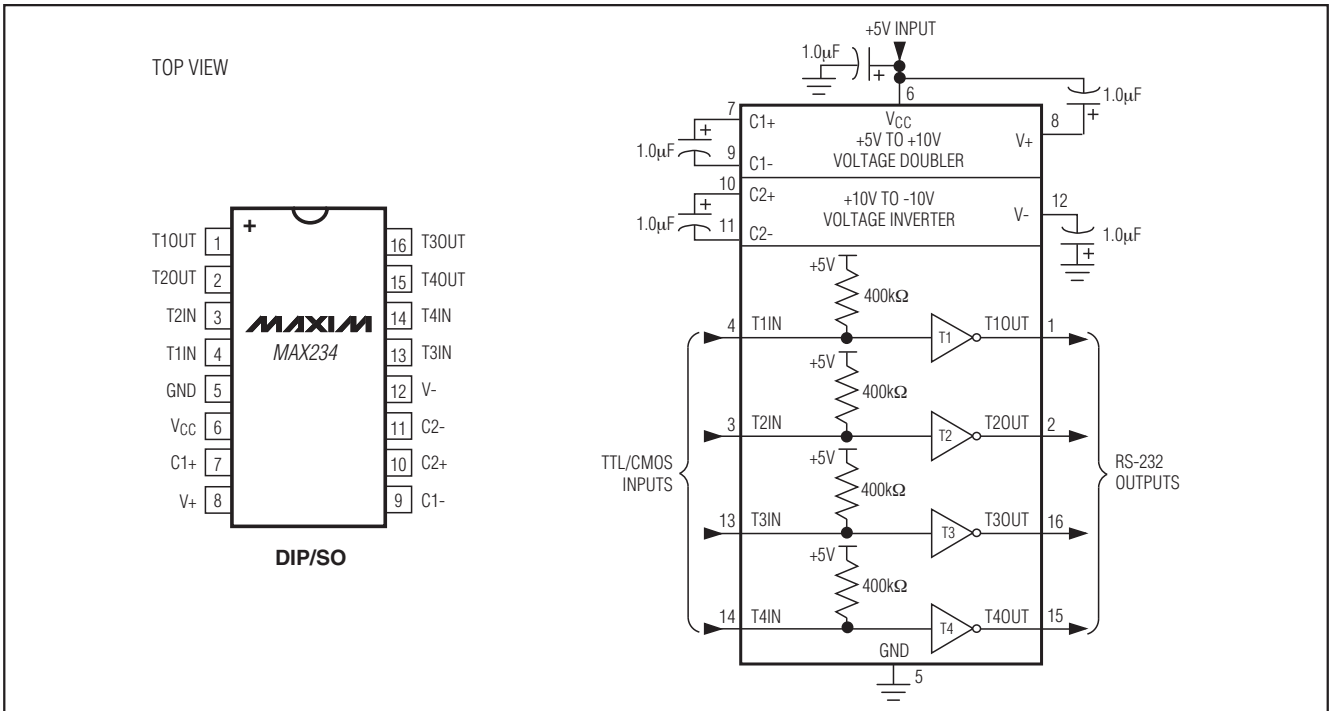
+5V供电、多通道RS-232 驱动器/接收器

MAX220-MAX249

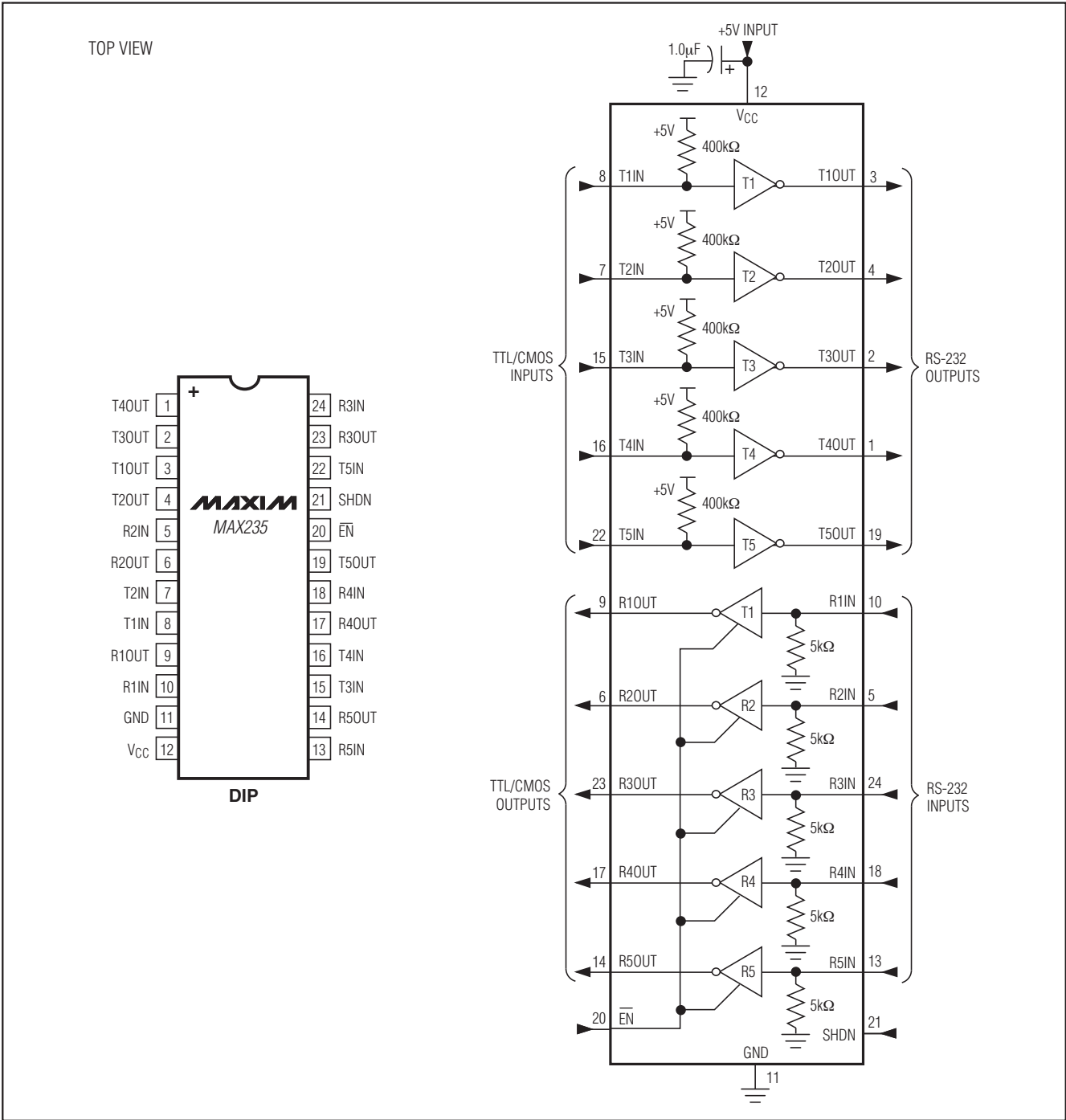

图14. MAX236引脚配置与典型工作电路

+5V供电、多通道RS-232 驱动器/接收器

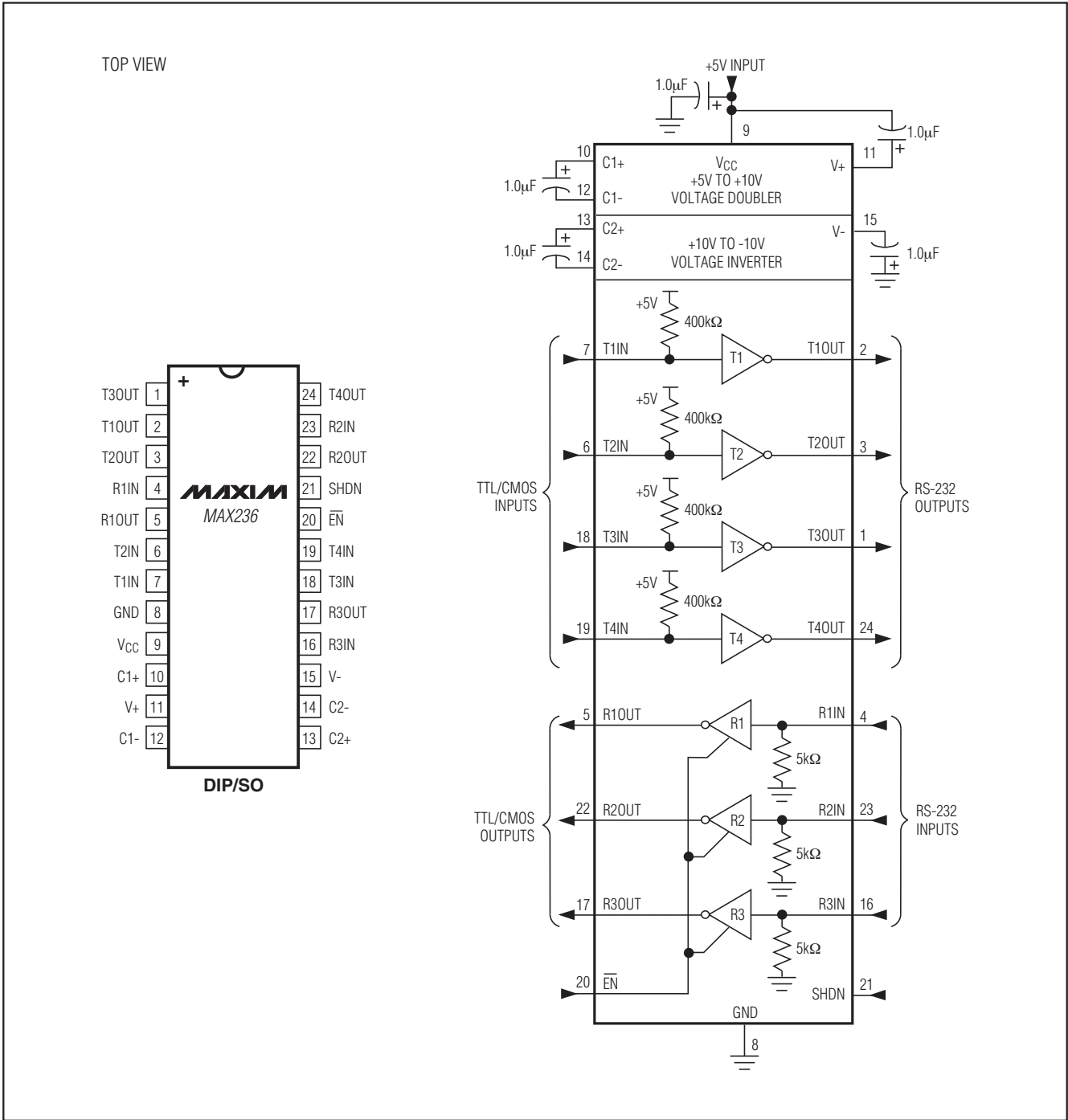

图15. MAX237引脚配置与典型工作电路

+5V供电、多通道RS-232 驱动器/接收器

MAX220-MAX249

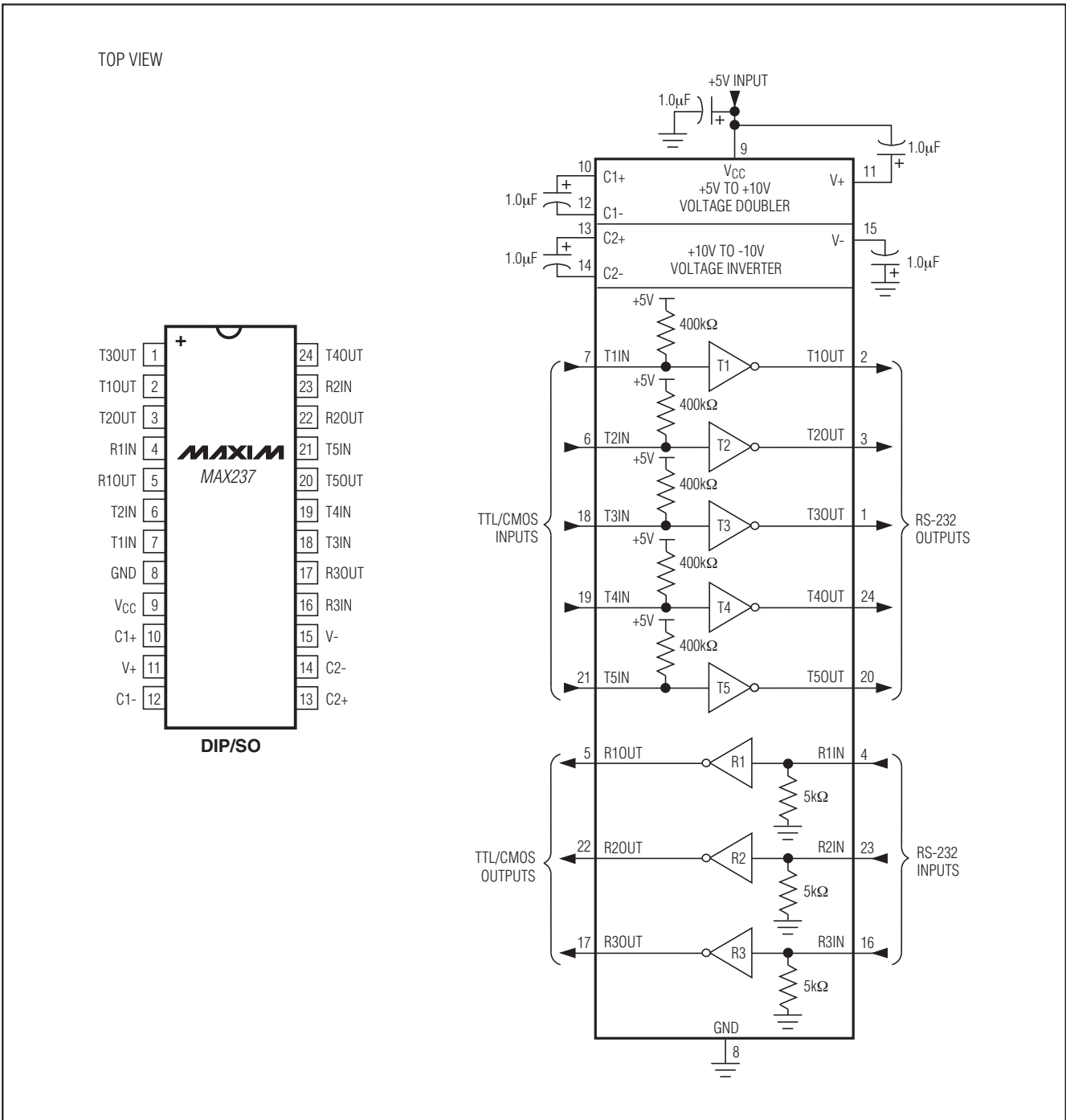

图16. MAX238 引脚配置与典型工作电路

+5V供电、多通道RS-232 驱动器/接收器

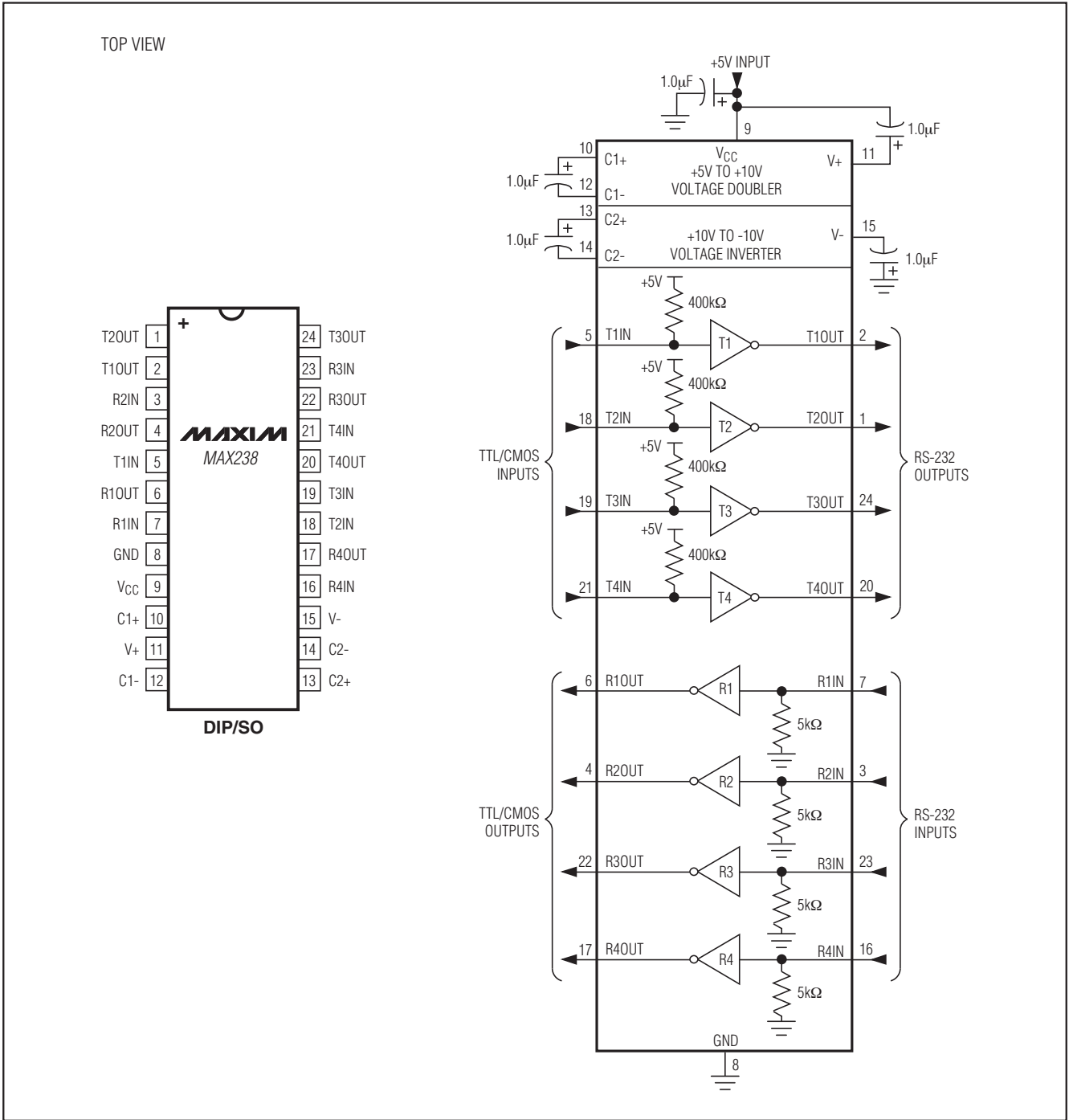

图17. MAX239 引脚配置与典型工作电路

+5V供电、多通道RS-232 驱动器/接收器

MAX220-MAX249

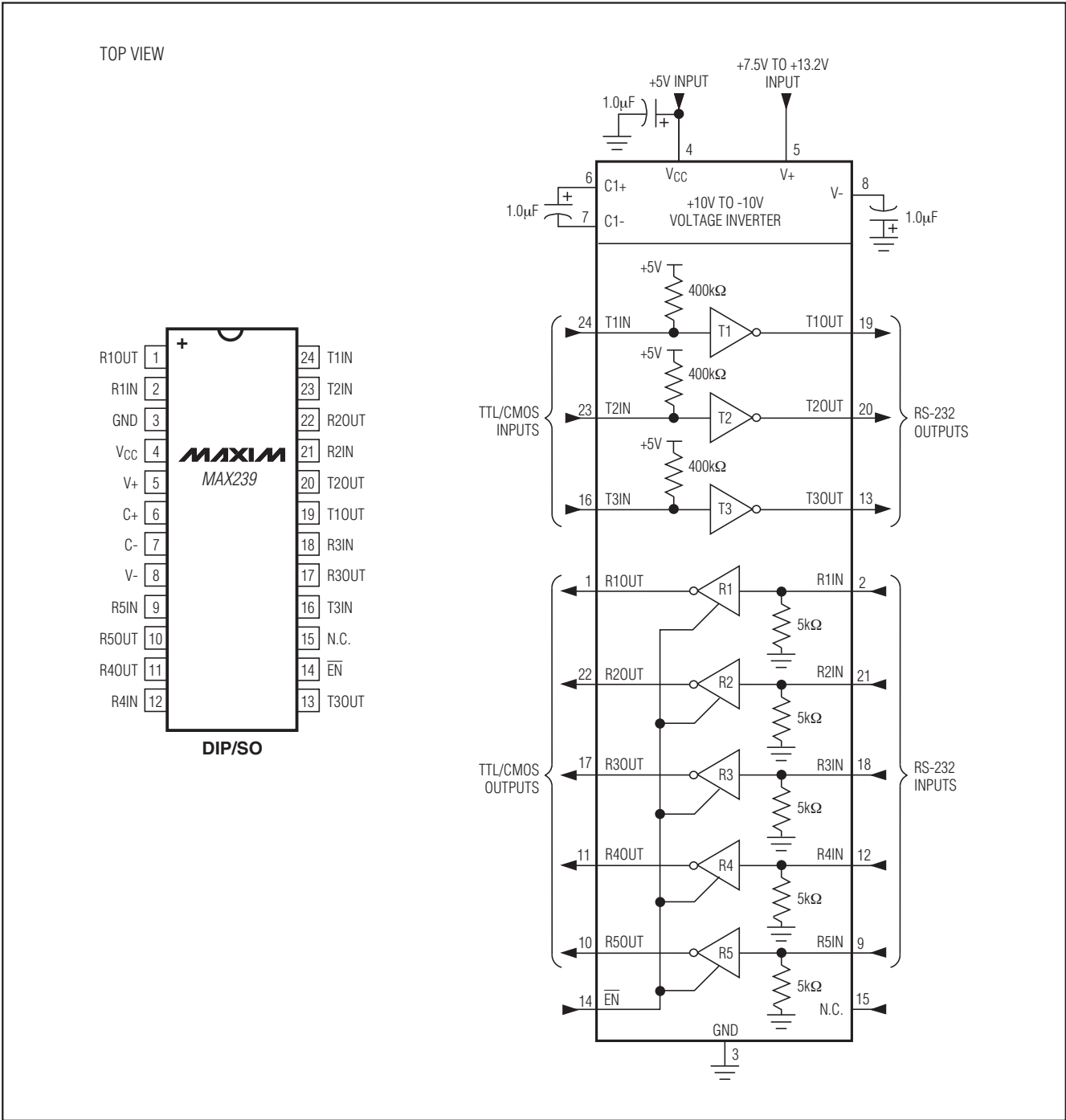

图18. MAX240 引脚配置与典型工作电路

+5V供电、多通道RS-232 驱动器/接收器

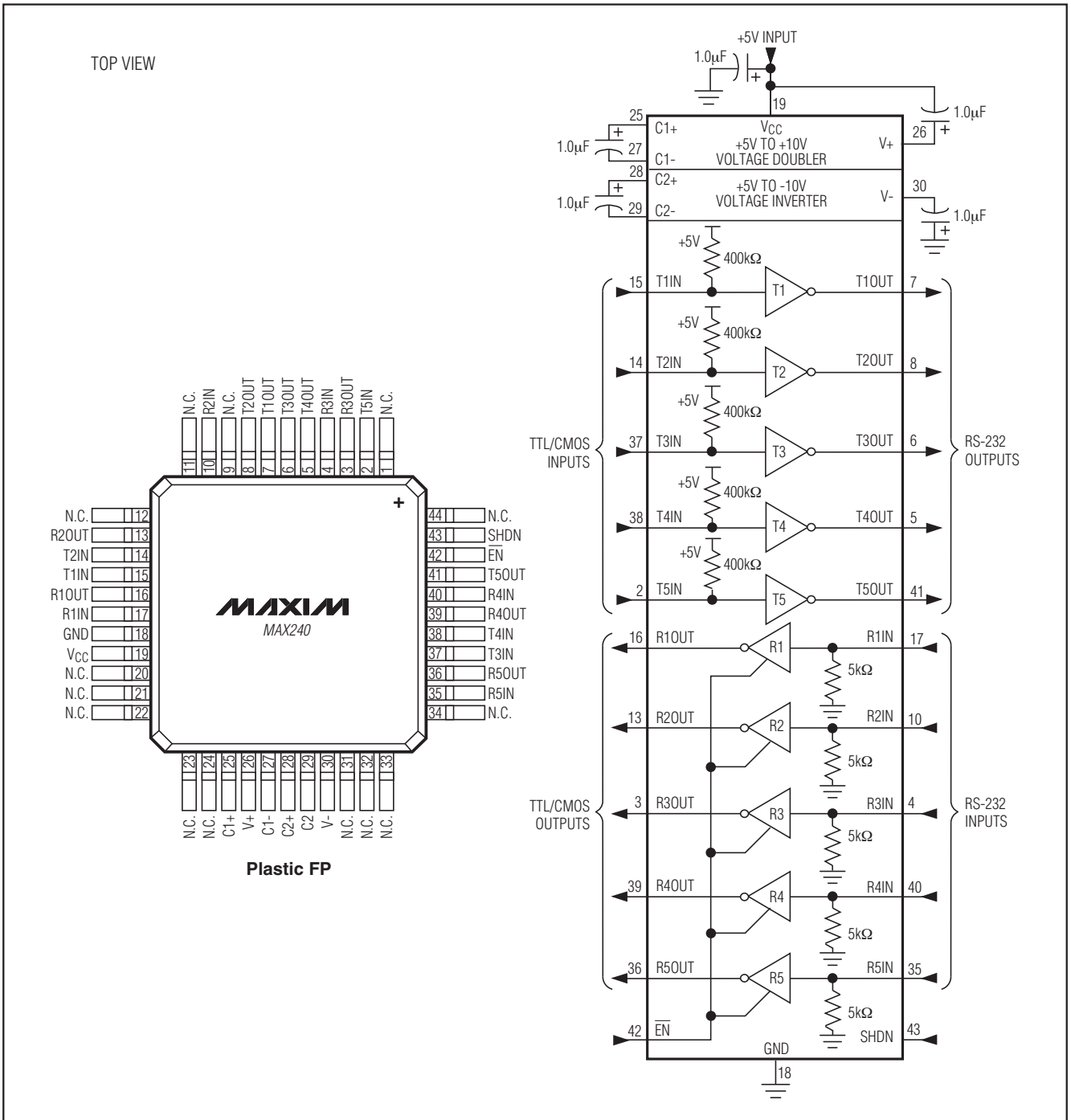

图19. MAX243 引脚配置与典型工作电路

+5V供电、多通道RS-232 驱动器/接收器

MAX220-MAX249

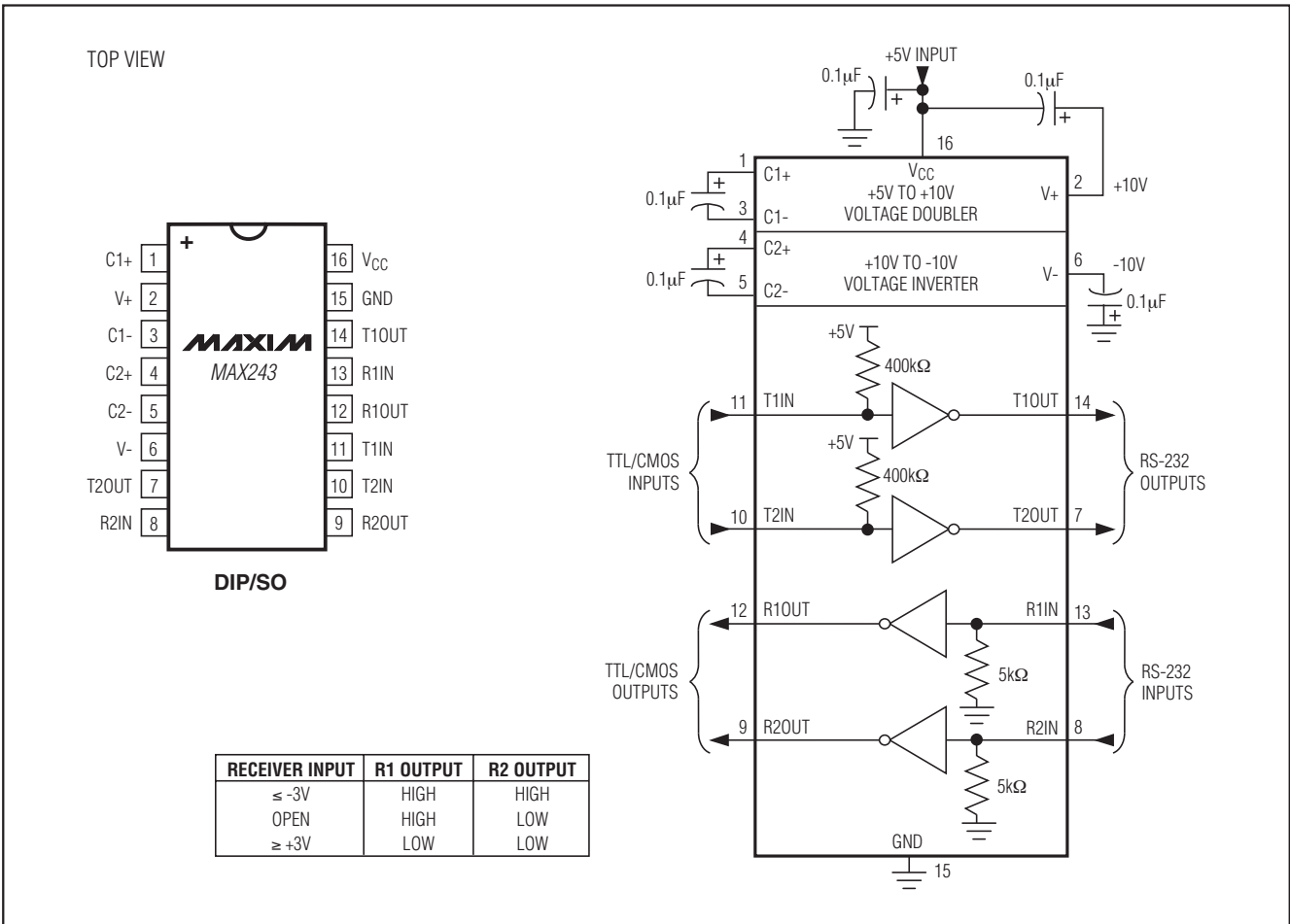

图20. MAX244 引脚配置与典型工作电路

+5V供电、多通道RS-232 驱动器/接收器

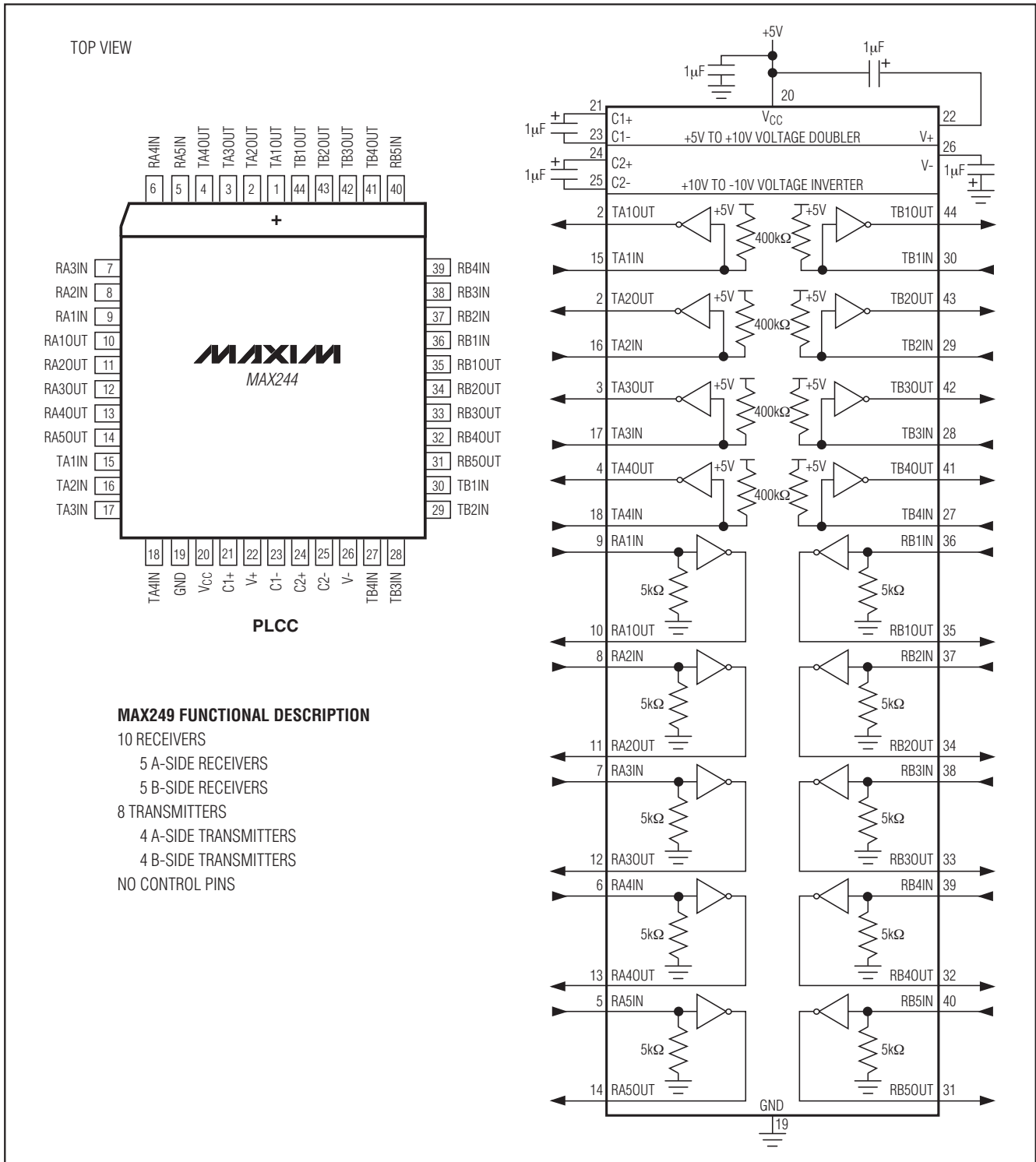

图21. MAX245 引脚配置与典型工作电路

+5V供电、多通道RS-232 驱动器/接收器

MAX220-MAX249

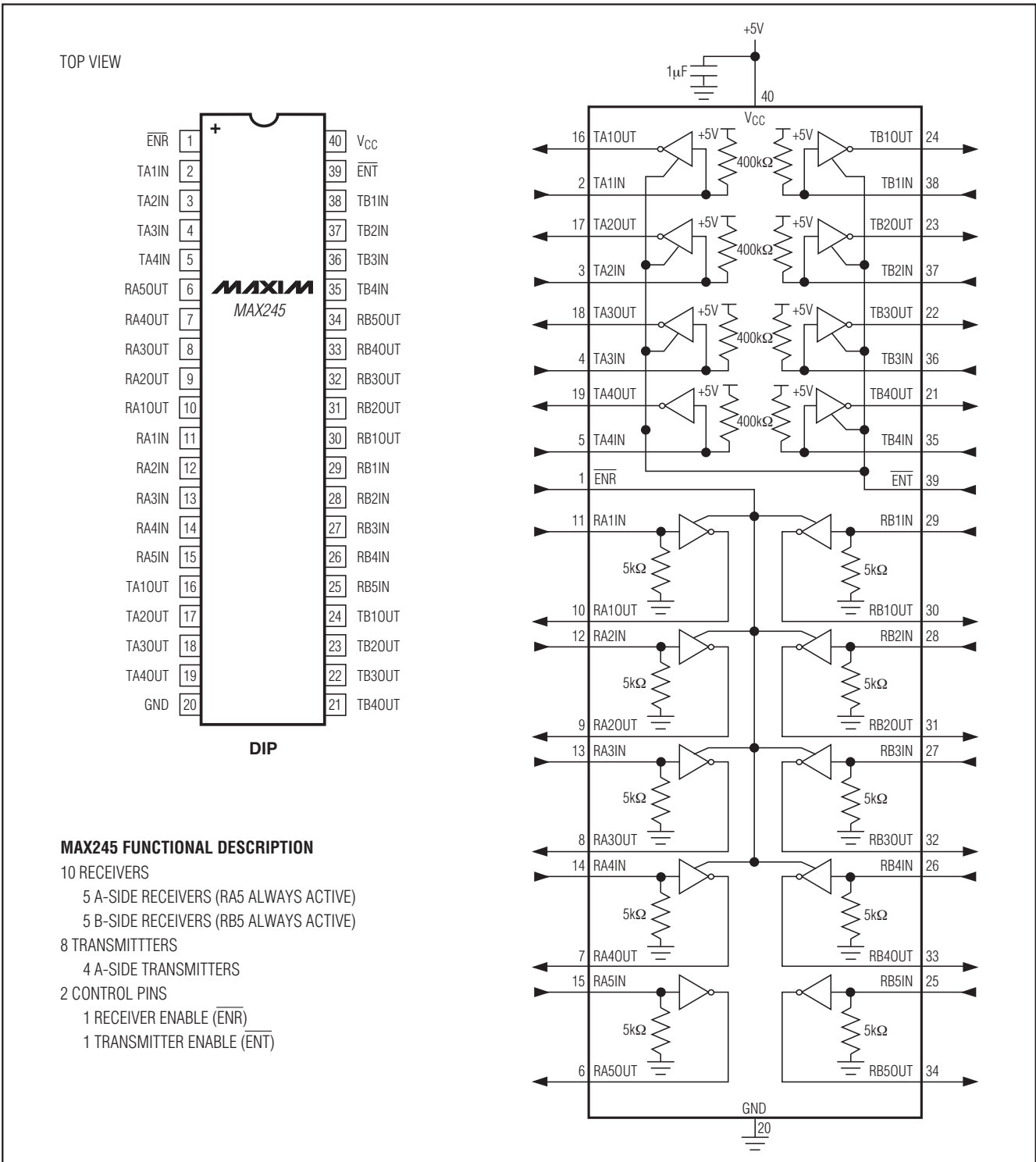

图22. MAX246引脚配置与典型工作电路

+5V供电、多通道RS-232 驱动器/接收器

TOP VIEW

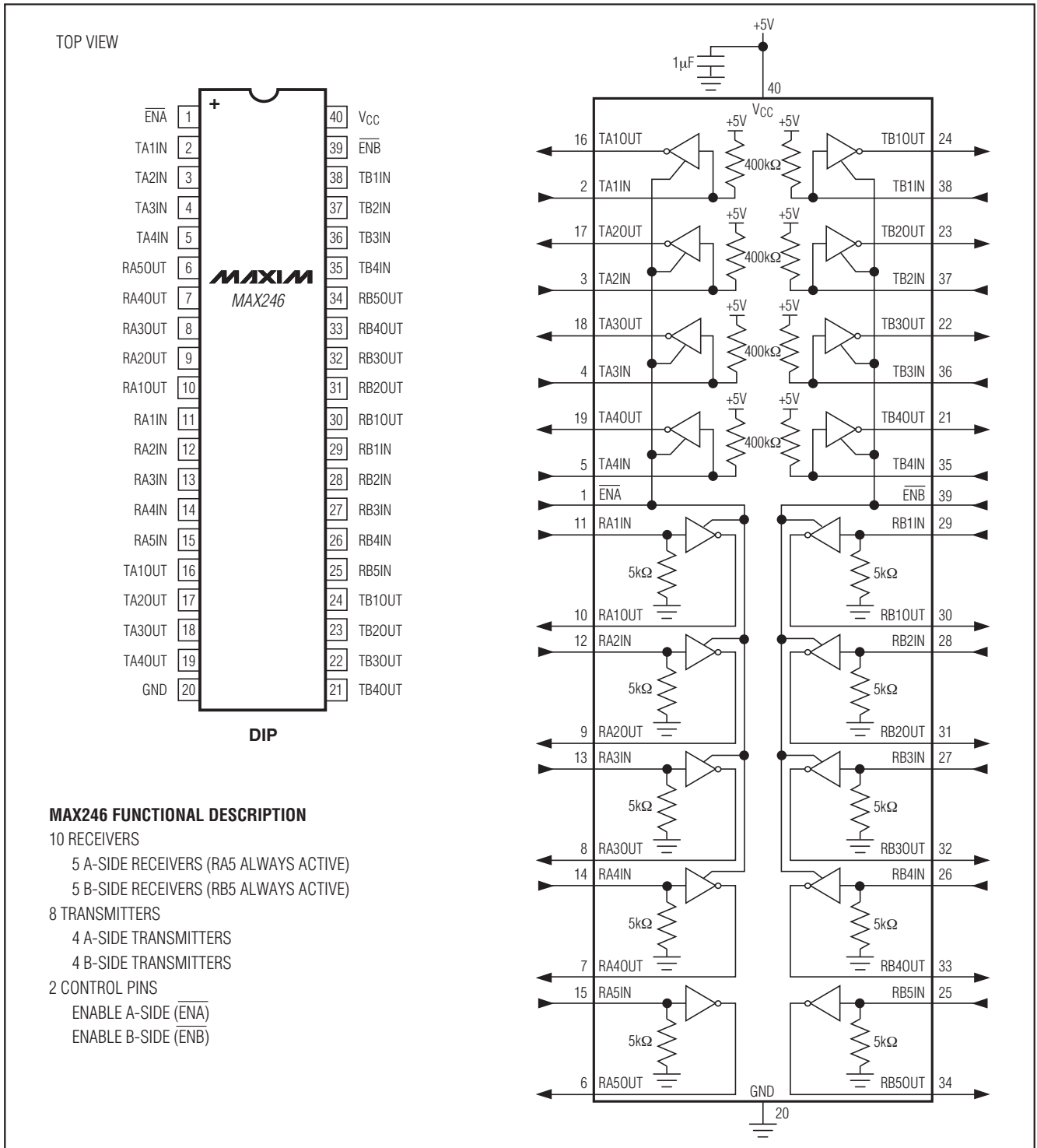
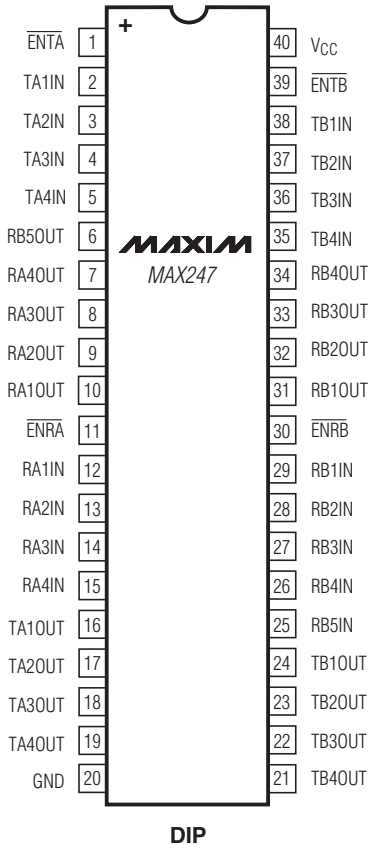

MAX247 FUNCTIONAL DESCRIPTION

- 9 RECEIVERS
 - 4 A-SIDE RECEIVERS
 - 5 B-SIDE RECEIVERS (RB5 ALWAYS ACTIVE)
- 8 TRANSMITTERS
 - 4 A-SIDE TRANSMITTERS
 - 4 B-SIDE TRANSMITTERS
- 4 CONTROL PINS
 - ENABLE RECEIVER A-SIDE (ENRĀ)
 - ENABLE RECEIVER B-SIDE (ENRB)
 - ENABLE RECEIVER A-SIDE (ENTĀ)
 - ENABLE RECEIVER B-SIDE (ENTB)



图23. MAX247引脚配置与典型工作电路

+5V供电、多通道RS-232 驱动器/接收器

MAX220-MAX249

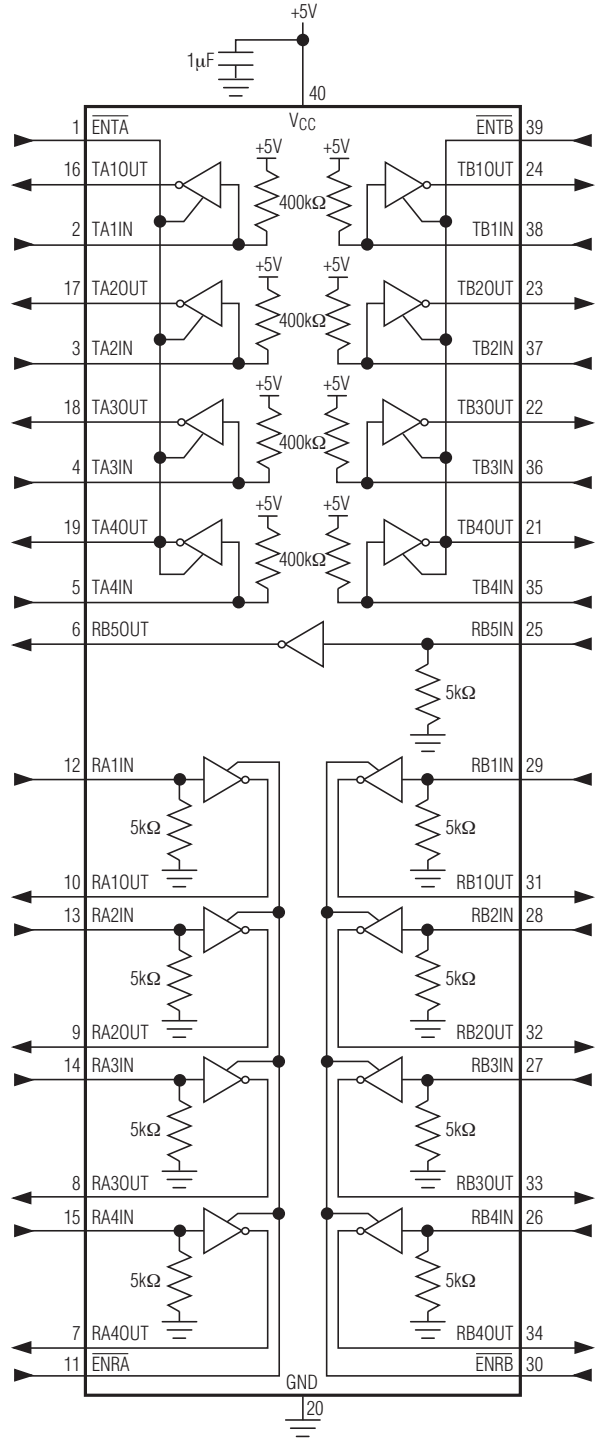

图24. MAX248 引脚配置与典型工作电路

+5V供电、多通道RS-232 驱动器/接收器

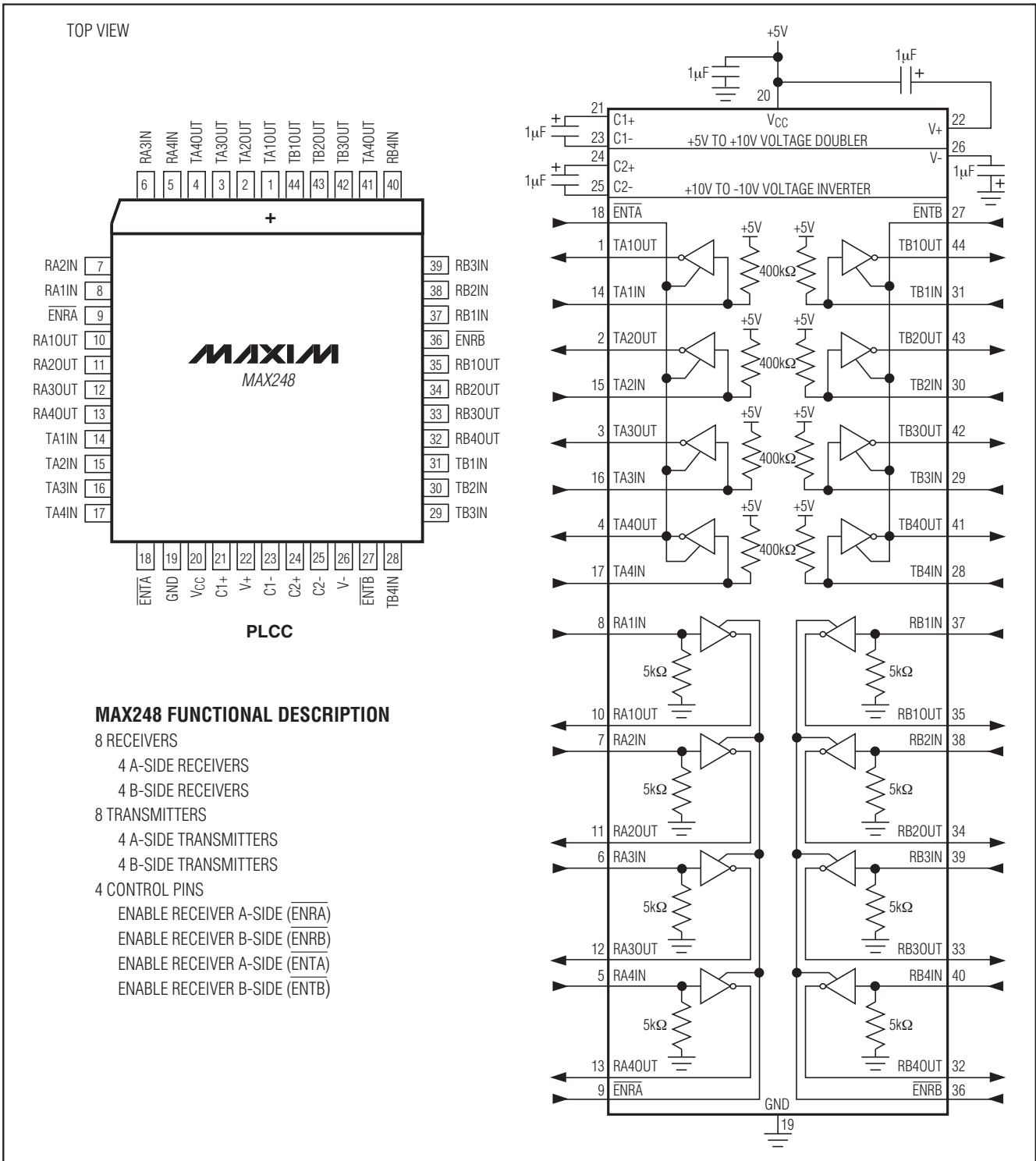

图25. MAX249 引脚配置与典型工作电路

+5V供电、多通道RS-232 驱动器/接收器

订购信息(续)

MAX220-MAX249

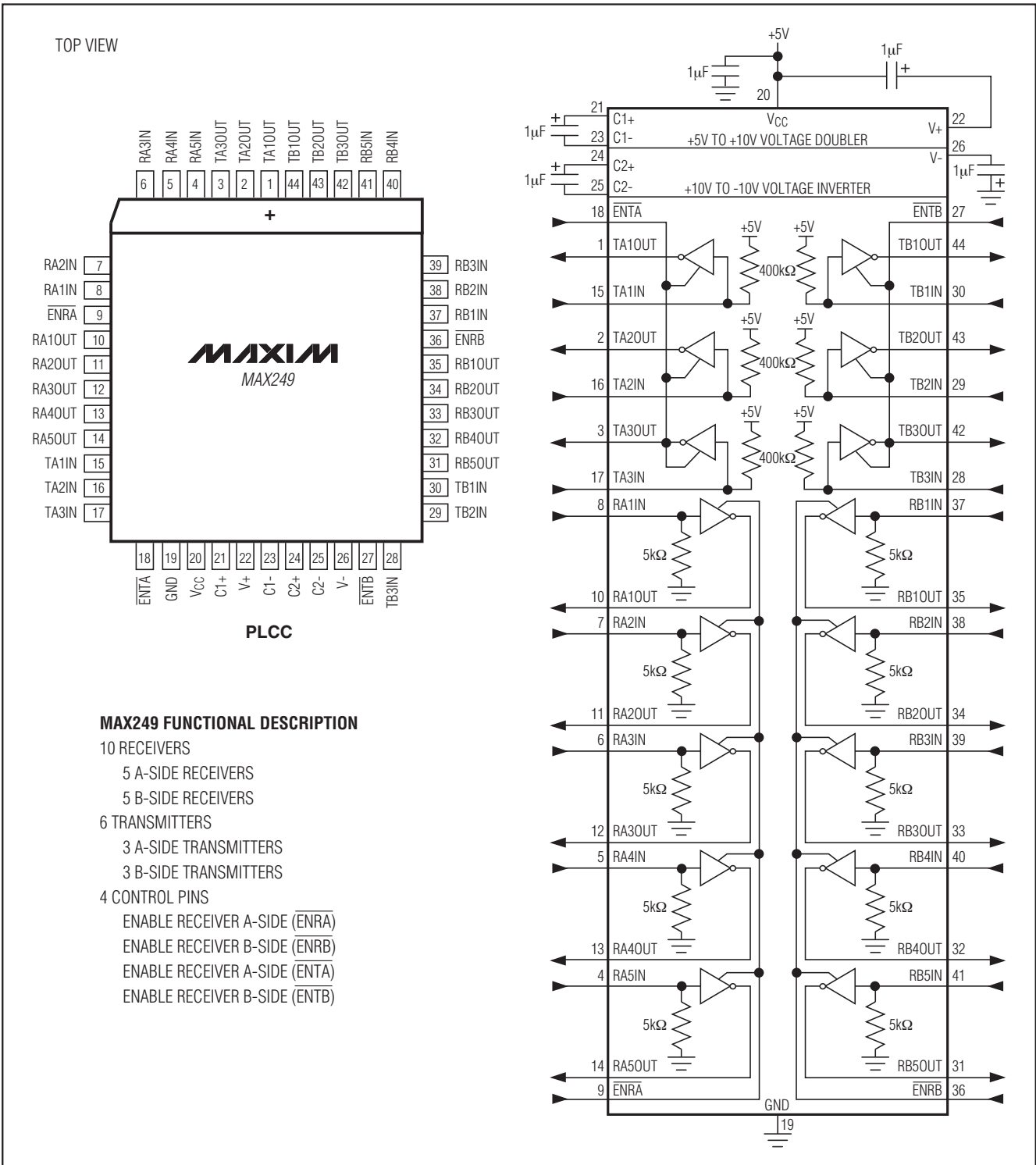
PART	TEMP RANGE	PIN-PACKAGE
MAX222CPN+	0°C to +70°C	18 Plastic DIP
MAX222CWN+	0°C to +70°C	18 Wide SO
MAX222C/D	0°C to +70°C	Dice*
MAX222EPN+	-40°C to +85°C	18 Plastic DIP
MAX222EWN+	-40°C to +85°C	18 Wide SO
MAX222EJN	-40°C to +85°C	18 CERDIP
MAX222MJN	-55°C to +125°C	18 CERDIP
MAX223CAI+	0°C to +70°C	28 SSOP
MAX223CWI+	0°C to +70°C	28 Wide SO
MAX223C/D	0°C to +70°C	Dice*
MAX223EAI+	-40°C to +85°C	28 SSOP
MAX223EWI+	-40°C to +85°C	28 Wide SO
MAX225CWI+	0°C to +70°C	28 Wide SO
MAX225EWI+	-40°C to +85°C	28 Wide SO
MAX230CPP+	0°C to +70°C	20 Plastic DIP
MAX230CWP+	0°C to +70°C	20 Wide SO
MAX230C/D	0°C to +70°C	Dice*
MAX230EPP+	-40°C to +85°C	20 Plastic DIP
MAX230EWP+	-40°C to +85°C	20 Wide SO
MAX230EJP	-40°C to +85°C	20 CERDIP
MAX230MJP	-55°C to +125°C	20 CERDIP
MAX231CPD+	0°C to +70°C	14 Plastic DIP
MAX231CWE+	0°C to +70°C	16 Wide SO
MAX231CJD	0°C to +70°C	14 CERDIP
MAX231C/D	0°C to +70°C	Dice*
MAX231EPD+	-40°C to +85°C	14 Plastic DIP
MAX231EWE+	-40°C to +85°C	16 Wide SO
MAX231EJD	-40°C to +85°C	14 CERDIP
MAX231MJD	-55°C to +125°C	14 CERDIP
MAX232CPE+	0°C to +70°C	16 Plastic DIP
MAX232CSE+	0°C to +70°C	16 Narrow SO
MAX232CWE+	0°C to +70°C	16 Wide SO
MAX232C/D	0°C to +70°C	Dice*
MAX232EPE+	-40°C to +85°C	16 Plastic DIP
MAX232ESE+	-40°C to +85°C	16 Narrow SO
MAX232EWE+	-40°C to +85°C	16 Wide SO
MAX232EJE	-40°C to +85°C	16 CERDIP
MAX232MJE	-55°C to +125°C	16 CERDIP
MAX232MLP+	-55°C to +125°C	20 LCC
MAX232ACPE+	0°C to +70°C	16 Plastic DIP
MAX232ACSE+	0°C to +70°C	16 Narrow SO
MAX232ACWE+	0°C to +70°C	16 Wide SO

PART	TEMP RANGE	PIN-PACKAGE
MAX232AC/D	0°C to +70°C	Dice*
MAX232AEPE+	-40°C to +85°C	16 Plastic DIP
MAX232AESE+	-40°C to +85°C	16 Narrow SO
MAX232AEWE+	-40°C to +85°C	16 Wide SO
MAX232AEJE	-40°C to +85°C	16 CERDIP
MAX232AMJE	-55°C to +125°C	16 CERDIP
MAX232AML+	-55°C to +125°C	20 LCC
MAX233CPP+	0°C to +70°C	20 Plastic DIP
MAX233EPP+	-40°C to +85°C	20 Plastic DIP
MAX233ACPP+	0°C to +70°C	20 Plastic DIP
MAX233ACWP+	0°C to +70°C	20 Wide SO
MAX233AEPP+	-40°C to +85°C	20 Plastic DIP
MAX233AEWP+	-40°C to +85°C	20 Wide SO
MAX234CPE+	0°C to +70°C	16 Plastic DIP
MAX234CWE+	0°C to +70°C	16 Wide SO
MAX234C/D	0°C to +70°C	Dice*
MAX234EPE+	-40°C to +85°C	16 Plastic DIP
MAX234EWE+	-40°C to +85°C	16 Wide SO
MAX234EJE	-40°C to +85°C	16 CERDIP
MAX234MJE	-55°C to +125°C	16 CERDIP
MAX235CPG+	0°C to +70°C	24 Wide Plastic DIP
MAX235EPG+	-40°C to +85°C	24 Wide Plastic DIP
MAX235EDG	-40°C to +85°C	24 Ceramic SB
MAX235MDG	-55°C to +125°C	24 Ceramic SB
MAX236CNG+	0°C to +70°C	24 Narrow Plastic DIP
MAX236CWG+	0°C to +70°C	24 Wide SO
MAX236C/D	0°C to +70°C	Dice*
MAX236ENG+	-40°C to +85°C	24 Narrow Plastic DIP
MAX236EWG+	-40°C to +85°C	24 Wide SO
MAX236ERG	-40°C to +85°C	24 Narrow CERDIP
MAX236MRG	-55°C to +125°C	24 Narrow CERDIP
MAX237CNG+	0°C to +70°C	24 Narrow Plastic DIP
MAX237CWG+	0°C to +70°C	24 Wide SO
MAX237C/D	0°C to +70°C	Dice*
MAX237ENG+	-40°C to +85°C	24 Narrow Plastic DIP
MAX237EWG+	-40°C to +85°C	24 Wide SO
MAX237ERG	-40°C to +85°C	24 Narrow CERDIP
MAX237MRG	-55°C to +125°C	24 Narrow CERDIP
MAX238CNG+	0°C to +70°C	24 Narrow Plastic DIP
MAX238CWG+	0°C to +70°C	24 Wide SO
MAX238C/D	0°C to +70°C	Dice*

+表示无铅(Pb)符合RoHS标准的封装。

*裸片规格, 请与工厂联系。

+5V供电、多通道RS-232 驱动器/接收器

订购信息(续)

PART	TEMP RANGE	PIN-PACKAGE
MAX238ENG+	-40°C to +85°C	24 Narrow Plastic DIP
MAX238EWG+	-40°C to +85°C	24 Wide SO
MAX238ERG	-40°C to +85°C	24 Narrow CERDIP
MAX238MRG	-55°C to +125°C	24 Narrow CERDIP
MAX239CNG+	0°C to +70°C	24 Narrow Plastic DIP
MAX239CWG+	0°C to +70°C	24 Wide SO
MAX239C/D	0°C to +70°C	Dice*
MAX239ENG+	-40°C to +85°C	24 Narrow Plastic DIP
MAX239EWG+	-40°C to +85°C	24 Wide SO
MAX239ERG	-40°C to +85°C	24 Narrow CERDIP
MAX239MRG	-55°C to +125°C	24 Narrow CERDIP
MAX240CMH+	0°C to +70°C	44 Plastic FP
MAX240C/D	0°C to +70°C	Dice*
MAX241CAI+	0°C to +70°C	28 SSOP
MAX241CWI+	0°C to +70°C	28 Wide SO
MAX241C/D	0°C to +70°C	Dice*
MAX241EAI+	-40°C to +85°C	28 SSOP
MAX241EWI+	-40°C to +85°C	28 Wide SO
MAX242CAP+	0°C to +70°C	20 SSOP
MAX242CPN+	0°C to +70°C	18 Plastic DIP
MAX242CWN+	0°C to +70°C	18 Wide SO
MAX242C/D	0°C to +70°C	Dice*
MAX242EPN+	-40°C to +85°C	18 Plastic DIP
MAX242EWN+	-40°C to +85°C	18 Wide SO
MAX242EJN	-40°C to +85°C	18 CERDIP
MAX242MJN	-55°C to +125°C	18 CERDIP

PART	TEMP RANGE	PIN-PACKAGE
MAX243CPE+	0°C to +70°C	16 Plastic DIP
MAX243CSE+	0°C to +70°C	16 Narrow SO
MAX243CWE+	0°C to +70°C	16 Wide SO
MAX243C/D	0°C to +70°C	Dice*
MAX243EPE+	-40°C to +85°C	16 Plastic DIP
MAX243ESE+	-40°C to +85°C	16 Narrow SO
MAX243EWE+	-40°C to +85°C	16 Wide SO
MAX243EJE	-40°C to +85°C	16 CERDIP
MAX243MJE	-55°C to +125°C	16 CERDIP
MAX244CQH+	0°C to +70°C	44 PLCC
MAX244C/D	0°C to +70°C	Dice*
MAX244EQH+	-40°C to +85°C	44 PLCC
MAX245CPL+	0°C to +70°C	40 Plastic DIP
MAX245C/D	0°C to +70°C	Dice*
MAX245EPL+	-40°C to +85°C	40 Plastic DIP
MAX246CPL+	0°C to +70°C	40 Plastic DIP
MAX246C/D	0°C to +70°C	Dice*
MAX246EPL+	-40°C to +85°C	40 Plastic DIP
MAX247CPL+	0°C to +70°C	40 Plastic DIP
MAX247C/D	0°C to +70°C	Dice*
MAX247EPL+	-40°C to +85°C	40 Plastic DIP
MAX248CQH+	0°C to +70°C	44 PLCC
MAX248C/D	0°C to +70°C	Dice*
MAX248EQH+	-40°C to +85°C	44 PLCC
MAX249CQH+	0°C to +70°C	44 PLCC
MAX249EQH+	-40°C to +85°C	44 PLCC

+表示无铅(Pb)/符合RoHS标准的封装。

*裸片规格, 请与工厂联系。

+5V供电、多通道RS-232 驱动器/接收器

封装信息

如需最近的封装外形信息和焊盘布局，请查询 china.maxim-ic.com/packages。请注意，封装编码中的“+”、“#”或“-”仅表示RoHS状态。封装图中可能包含不同的尾缀字符，但封装图只与封装有关，与RoHS状态无关。

封装类型	封装编码	外形编号	焊盘布局编号
14 PDIP	P14+3	21-0043	—
16 PDIP	P16+1		
16 PDIP	P16+2		
16 PDIP	P16+3		
18 PDIP	P18+5		
20 PDIP	P20+3		
20 PDIP	P20M+1		
24 PDIP	N24+3		
24 PDIP	P24M+1		
28 PDIP	P28+2		
40 PDIP	P40+1		
40 PDIP	P40M+2		
14 CERDIP	J14-3	21-0045	—
16 CERDIP	J16-3		
18 CERDIP	J18-2		
20 CERDIP	J20-2		
24 CERDIP	R24-4		
16 SO(N)	S16+3	21-0041	90-0097
16 SO(N)	S16+5		
16 SO(W)	W16+1	21-0042	90-0107
16 SO(W)	W16+2		
16 SO(W)	W16+3		
18 SO(W)	W18+1		90-0181
20 SO(W)	W20+3		
20 SO(W)	W20M+1		90-0108
24 SO(W)	W24+2		
28 SO(W)	W28+1		90-0109
28 SO(W)	W28+2		
28 SO(W)	W28M+1		90-0177
20 LCC	L20+3		
20 SSOP	A20+1	21-0056	90-0094
24 SSOP	A24+2		90-0110
28 SSOP	A28+1		90-0095
16 TSSOP	U16+1		90-0117
16 FPCK	F16-3		21-0013
44 MQFP	M44+5	21-0826	90-0169
44 PLCC	Q44+1	21-0049	90-0236
44 PLCC	Q44+2		

MAX220-MAX249

+5V供电、多通道RS-232 驱动器/接收器

修订历史

修订号	修订日期	说明	修改页
15	1/06	在 <i>Absolute Maximum Ratings</i> 部分的引脚温度中增加了型号信息。	2, 5, 8
16	7/10	将多个封装更改为无铅版本；在 <i>Electrical Characteristics</i> 表中更新/增加了注释3、4、5、7和8；删除了 <i>Electrical Characteristics</i> 表和引脚配置中不正确的引脚名称下标。	1, 2-9, 17-36

Maxim北京办事处

北京 8328 信箱 邮政编码 100083

免费电话：800 810 0310

电话：010-6211 5199

传真：010-6211 5299

Maxim不对Maxim产品以外的任何电路使用负责，也不提供其专利许可。Maxim保留在任何时间、没有任何通报的前提下修改产品资料和规格的权利。

38 **Maxim Integrated Products, 120 San Gabriel Drive, Sunnyvale, CA 94086 408-737-7600**

© 2010 Maxim Integrated Products

Maxim 是 Maxim Integrated Products, Inc. 的注册商标。