



N-Channel Enhancement-Mode Vertical DMOS FET

Features

- ▶ Free from secondary breakdown
- ▶ Low power drive requirement
- ▶ Ease of paralleling
- ▶ Low C_{iss} and fast switching speeds
- ▶ Excellent thermal stability
- ▶ Integral source-drain diode
- ▶ High input impedance and high gain
- ▶ Complementary N- and P-channel devices

Applications

- ▶ Logic level interfaces - ideal for TTL and CMOS
- ▶ Solid state relays
- ▶ Battery operated systems
- ▶ Photo-voltaic drives
- ▶ Analog switches
- ▶ General purpose line drivers
- ▶ Telecom switches

General Description

This low threshold, enhancement-mode (normally-off) transistor utilizes a vertical DMOS structure and Supertex's well-proven, silicon-gate manufacturing process. This combination produces a device with the power handling capabilities of bipolar transistors and the high input impedance and positive temperature coefficient inherent in MOS devices. Characteristic of all MOS structures, this device is free from thermal runaway and thermally-induced secondary breakdown.

Supertex's vertical DMOS FETs are ideally suited to a wide range of switching and amplifying applications where very low threshold voltage, high breakdown voltage, high input impedance, low input capacitance, and fast switching speeds are desired.

Ordering Information

Device	Package Option		BV_{DSS}/BV_{DGS} (V)	$R_{DS(ON)}$ (max) (Ω)	$V_{GS(th)}$ (max) (V)
	TO-236AB (SOT-23)	TO-92			
TN2106	TN2106K1-G	TN2106N3-G	60	2.5	2.0

-G indicates package is RoHS compliant ('Green')



Absolute Maximum Ratings

Parameter	Value
Drain-to-source	BV_{DSS}
Drain-to-gate	BV_{DGS}
Gate-to-source	$\pm 20V$
Operating and storage temperature	$-55^{\circ}C$ to $+150^{\circ}C$
Soldering temperature*	$300^{\circ}C$

Absolute Maximum Ratings are those values beyond which damage to the device may occur. Functional operation under these conditions is not implied. Continuous operation of the device at the absolute rating level may affect device reliability. All voltages are referenced to device ground.

* Distance of 1.6mm from case for 10 seconds.

Pin Configurations



TO-236AB (SOT-23) (K1)

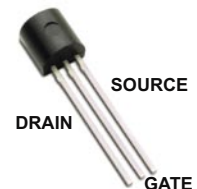

TO-92 (N3)

Product Marking

N1LW W = Code for week sealed
 = "Green" Packaging

TO-236AB (SOT-23) (K1)

TN YY = Year Sealed
2106 WW = Week Sealed
 = "Green" Packaging

TO-92 (N3)

Thermal Characteristics

Package	I_D (continuous) [†] (mA)	I_D (pulsed) (A)	Power Dissipation @ $T_A = 25^\circ\text{C}$ (W)	θ_{jc} ($^\circ\text{C}/\text{W}$)	θ_{ja} ($^\circ\text{C}/\text{W}$)	I_{DR}^{\dagger} (mA)	I_{DRM} (A)
TO-236AB (SOT-23)	280	0.8	0.36	200	350	280	0.8
TO-92	300	1.0	0.74	125	170	300	1.0

Notes:

[†] I_D (continuous) is limited by max rated T_J .

Electrical Characteristics ($T_A = 25^\circ\text{C}$ unless otherwise specified)

Sym	Parameter	Min	Typ	Max	Units	Conditions
BV_{DSS}	Drain-to-source breakdown voltage	60	-	-	V	$V_{GS} = 0V, I_D = 1.0mA$
$V_{GS(th)}$	Gate threshold voltage	0.6	-	2.0	V	$V_{GS} = V_{DS}, I_D = 1.0mA$
$\Delta V_{GS(th)}$	Change in $V_{GS(th)}$ with temperature	-	-3.8	-5.5	mV/ $^\circ\text{C}$	$V_{GS} = V_{DS}, I_D = 1.0mA$
I_{GSS}	Gate body leakage	-	0.1	100	nA	$V_{GS} = \pm 20V, V_{DS} = 0V$
I_{DSS}	Zero gate voltage drain current	-	-	1.0	μA	$V_{GS} = 0V, V_{DS} = \text{Max Rating}$
		-	-	100		$V_{DS} = 0.8\text{Max Rating}, V_{GS} = 0V, T_A = 125^\circ\text{C}$
$I_{D(ON)}$	On-state drain current	0.6	-	-	A	$V_{GS} = 10V, V_{DS} = 25V$
$R_{DS(ON)}$	Static drain-to-source on-state resistance	-	-	5.0	Ω	$V_{GS} = 4.5V, I_D = 200mA$
		-	-	2.5		$V_{GS} = 10V, I_D = 500mA$
$\Delta R_{DS(ON)}$	Change in $R_{DS(ON)}$ with temperature	-	0.70	1.0	%/ $^\circ\text{C}$	$V_{GS} = 10V, I_D = 500mA$
G_{FS}	Forward transductance	150	400	-	mmho	$V_{DS} = 25V, I_D = 500mA$
C_{ISS}	Input capacitance	-	35	50	pF	$V_{GS} = 0V, V_{DS} = 25V, f = 1.0MHz$
C_{OSS}	Common source output capacitance	-	17	25		
C_{RSS}	Reverse transfer capacitance	-	7.0	8.0		
$t_{d(ON)}$	Turn-on delay time	-	3.0	5.0	ns	$V_{DD} = 25V, I_D = 0.5A, R_{GEN} = 25\Omega$
t_r	Rise time	-	5.0	8.0		
$t_{d(OFF)}$	Turn-off delay time	-	6.0	9.0		
t_f	Fall time	-	5.0	8.0		
V_{SD}	Diode forward voltage drop	-	1.2	1.8	V	$V_{GS} = 0V, I_{SD} = 500mA$
t_{rr}	Reverse recovery time	-	400	-	ns	$V_{GS} = 0V, I_{SD} = 500mA$

Notes:

1. All D.C. parameters 100% tested at 25°C unless otherwise stated. (Pulse test: $300\mu\text{s}$ pulse, 2% duty cycle.)
2. All A.C. parameters sample tested.

Switching Waveforms and Test Circuit

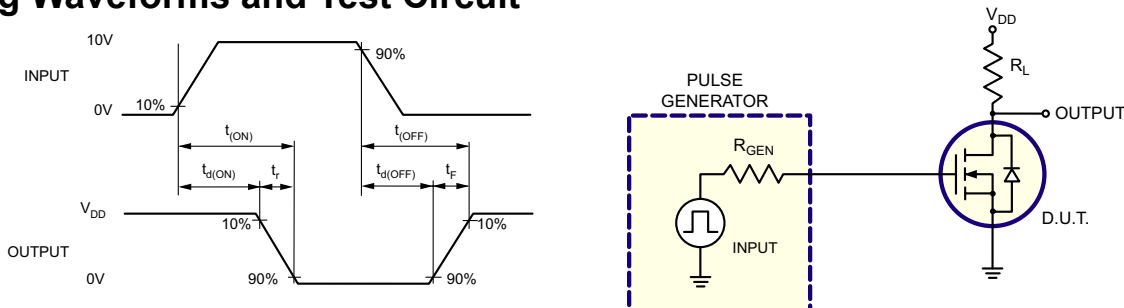

Typical Performance Curves

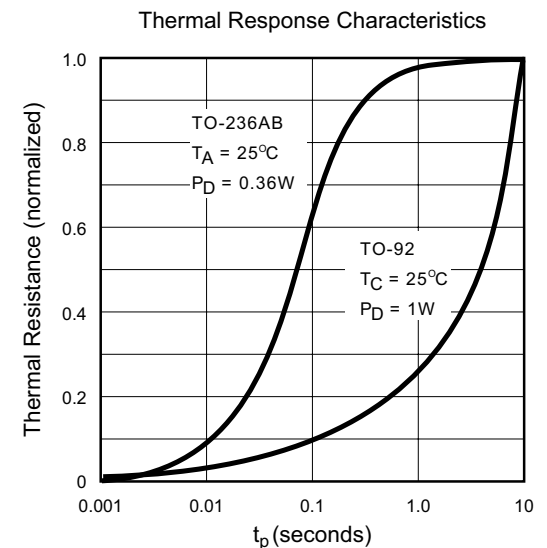
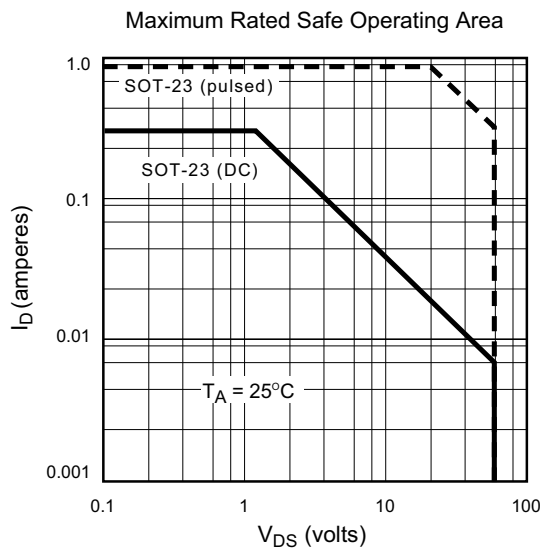
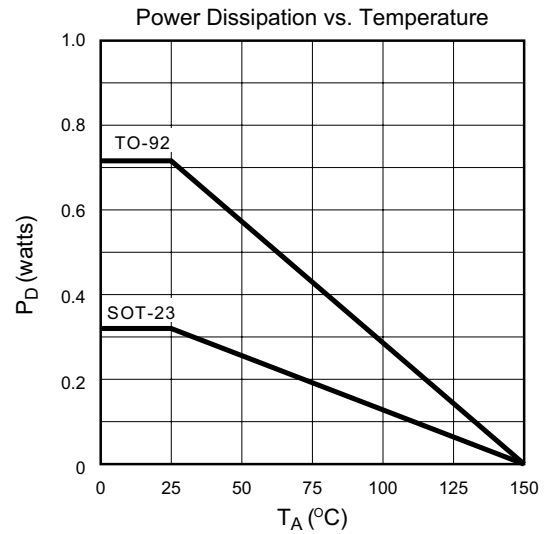
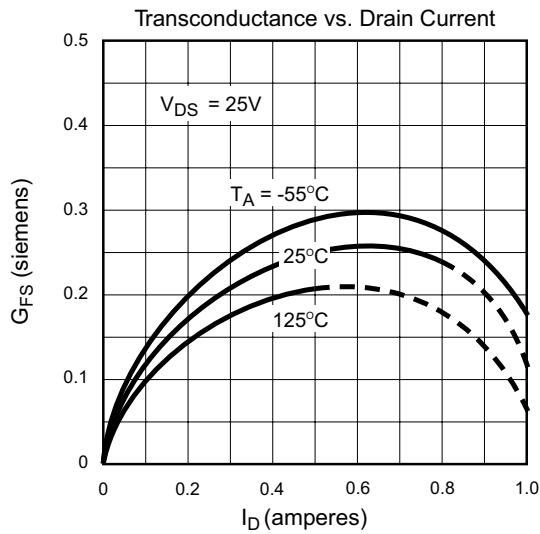
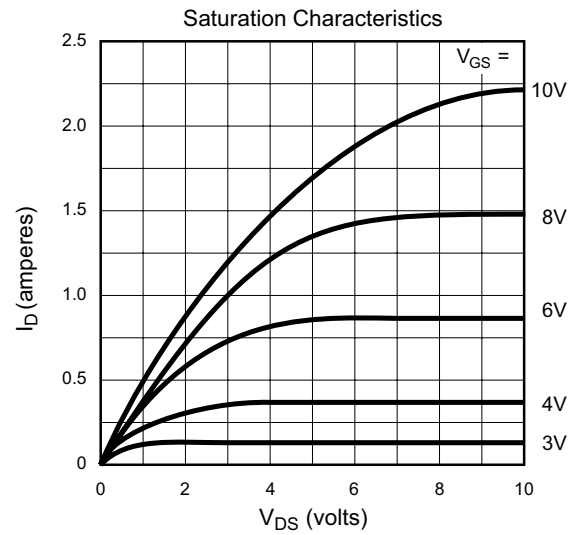
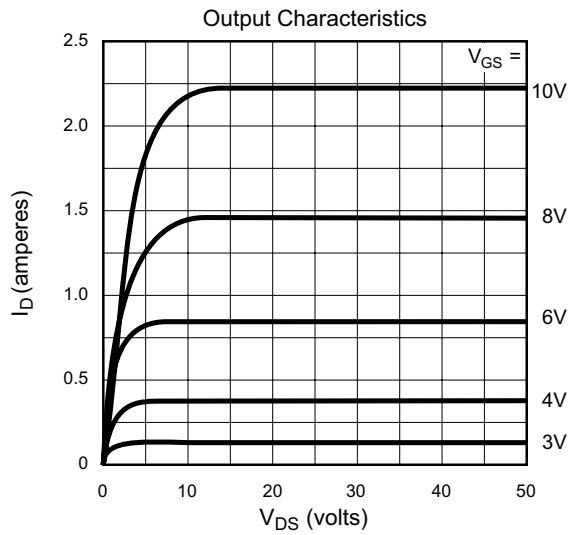

Typical Performance Curves (cont.)

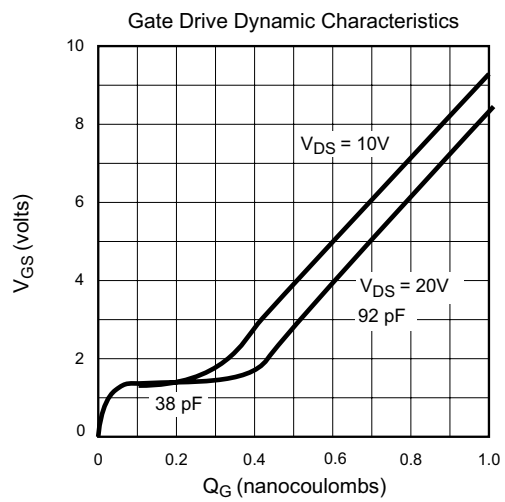
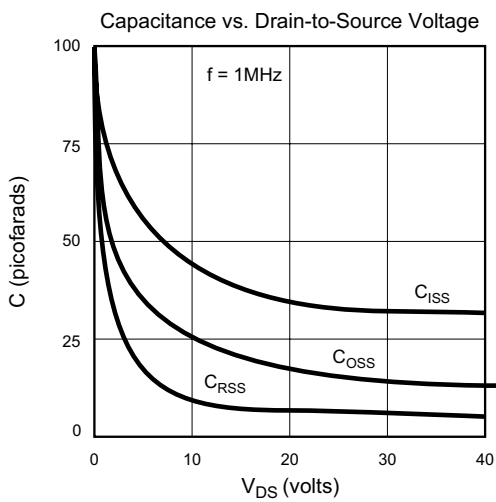
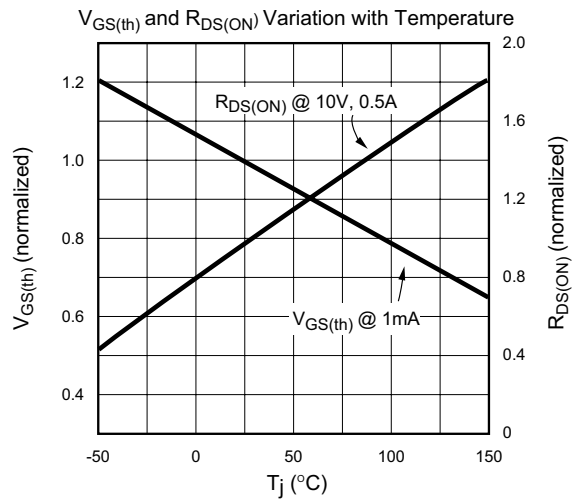
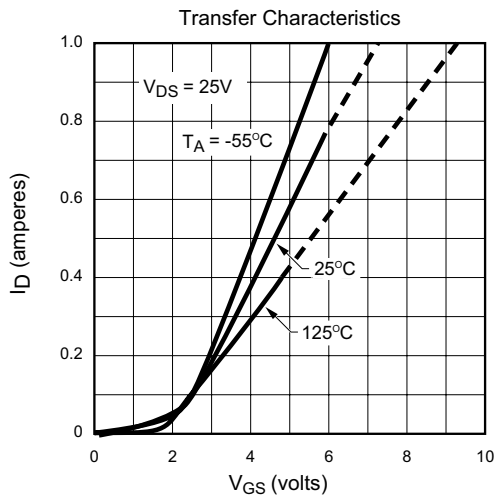
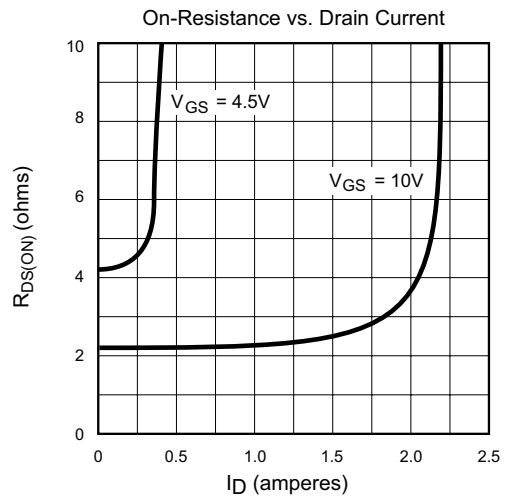
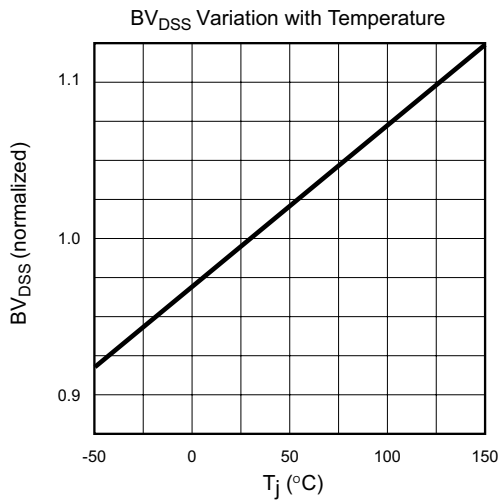

3-Lead TO-236AB (SOT-23) Package Outline (K1/T)

2.90x1.30mm body, 1.12mm height (max), 1.90mm pitch

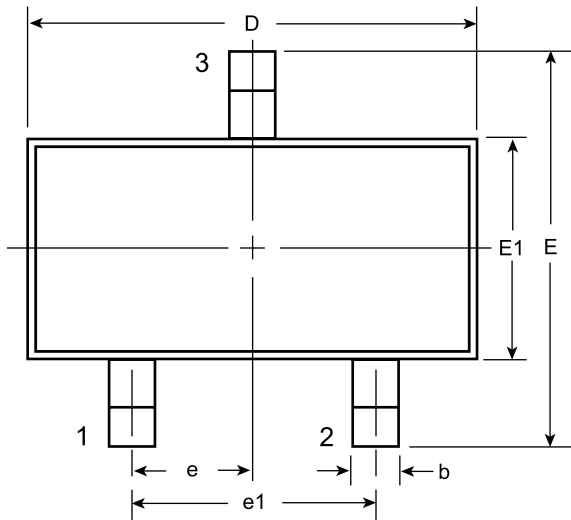

Top View

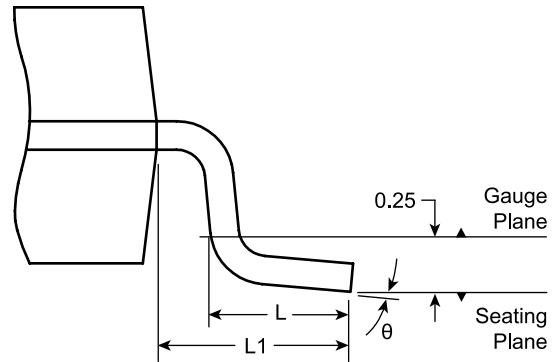

View B

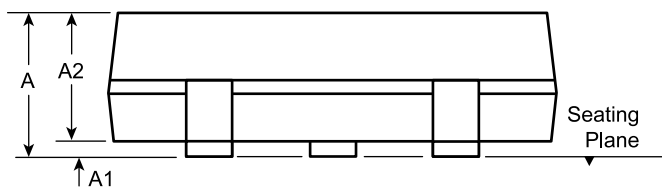

Side View

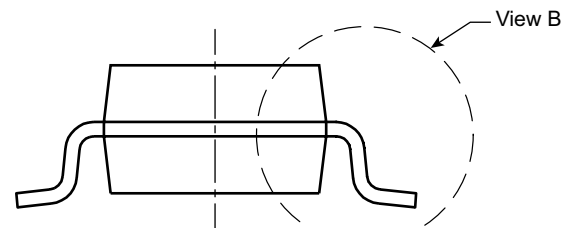

View A - A

Symbol	A	A1	A2	b	D	E	E1	e	e1	L	L1	θ	
Dimension (mm)	MIN	0.89	0.01	0.88	0.30	2.80	2.10	1.20	0.95 BSC	1.90 BSC	0.20 [†]	0.54 REF	0°
	NOM	-	-	0.95	-	2.90	-	1.30			0.50		-
	MAX	1.12	0.10	1.02	0.50	3.04	2.64	1.40			0.60		8°

JEDEC Registration TO-236, Variation AB, Issue H, Jan. 1999.

[†] This dimension is a non-JEDEC dimension.

Drawings not to scale.

Supertex Doc.#: DSPD-3TO236ABK1, Version B072208.

3-Lead TO-92 Package Outline (N3)

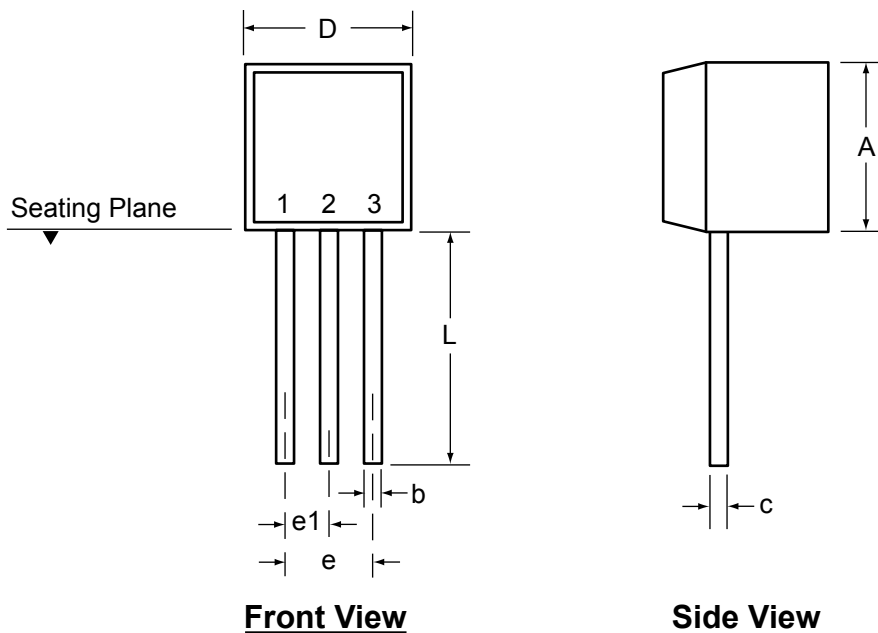

Symbol		A	b	c	D	E	E1	e	e1	L
Dimensions (inches)	MIN	.170	.014 [†]	.014 [†]	.175	.125	.080	.095	.045	.500
	NOM	-	-	-	-	-	-	-	-	-
	MAX	.210	.022 [†]	.022 [†]	.205	.165	.105	.105	.055	.610*

JEDEC Registration TO-92.

* This dimension is not specified in the original JEDEC drawing. The value listed is for reference only.

† This dimension is a non-JEDEC dimension.

Drawings not to scale.

Supertex Doc.#: DSPD-3TO92N3, Version D080408.

(The package drawing(s) in this data sheet may not reflect the most current specifications. For the latest package outline information go to <http://www.supertex.com/packaging.html>.)

Supertex inc. does not recommend the use of its products in life support applications, and will not knowingly sell them for use in such applications unless it receives an adequate "product liability indemnification insurance agreement." Supertex inc. does not assume responsibility for use of devices described, and limits its liability to the replacement of the devices determined defective due to workmanship. No responsibility is assumed for possible omissions and inaccuracies. Circuitry and specifications are subject to change without notice. For the latest product specifications refer to the Supertex inc. website: <http://www.supertex.com>.

Mouser Electronics

Authorized Distributor

Click to View Pricing, Inventory, Delivery & Lifecycle Information:

Microchip:

[TN2106N3-P002](#) [TN2106N3-P014](#) [TN2106N3-P003](#) [TN2106N3-P013](#) [TN2106K1-G](#) [TN2106N3-P002-G](#)
[TN2106N3-P014-G](#) [TN2106N3-P013-G](#) [TN2106N3-G](#) [TN2106N3-P003-G](#) [TN2106K1](#) [TN2106N3](#) [TN2106N3-G P014](#)
[TN2106N3-G P003](#) [TN2106N3-G P005](#) [TN2106N3-G P013](#) [TN2106N3-G P002](#)